

Teknoloji profesyonellikle birleŖti  
Technology combined with professionalism

**SMOXH**<sup>®</sup>  
CUTTING TOOLS



[www.smoXH.com.tr](http://www.smoXH.com.tr)

2019-2020 ÜRÜN KATALOĐU  
2019-2020 PRODUCT CATALOG

# KURUMSAL

## CORPORATE

2004 yılında sanayi sektörüne adım atan firmamız, kurucumuz Mustafa ŞİMŞEK tarafından üretime odaklanarak, kalite yolunda büyük bir azim ve kararlılıkla kesici takım bağlama ekipmanları üretme kararı ile yola çıkmıştır.

Kurulduğu günden beri büyük bir azim ve kararlılıkla önce Türkiye pazarına satış gerçekleştirip daha sonra başta Avrupa pazarı olmak üzere bir çok ülkeye ihracat yapmaktadır.

**Smoxh** markası hızla büyüyerek ve kalite odaklı bir marka olma yolunda hızlı ve güçlü şekilde ilerleyerek aranan ve müşterileri tarafından istenen bir marka haline gelmiştir. **Smoxh** gelişen teknolojiyi yakından takip ederek sürekli kendini yenilemiş, ürün çeşitliliğini arttırmıştır.

Çalışkan, yenilikçi, dinamik ve eğitimli çalışma arkadaşları ile ben değil BİZ ilkesini benimseyen bir firma haline gelmiştir.

Kurulduğu günden beri gelişen teknolojiyi takip etmiş ve CNC tezgahlara yatırım yaparak üretim kalitesini artırmıştır.

Başta mesai arkadaşlarımıza ve siz değerli müşterilerimize sonsuz teşekkür ederiz.

Our company which has been in 2004 by Mustafa ŞİMŞEK on industry sector is manufacturing cutting tool holders under the brand name Smoxh Cutting Tools.

Our company has been working with a great confidence and patience since its establishment and now we are making sales to many countries especially Turkey and European countries.

In 2015 year decided that export brand Smoxh in domestic market continue with innovation.

Our company has kept up with technology improved its machine park and increased product range capacity with computerized workbenches also achieved to become a demanded brand in the market by maximizing product quality. Our company has aspired to keep the customer satisfaction in highest level and in this context achieved to increase product quality and to keep the prices under market conditions.

Firstly, thank you to our personnels and our customers for our developments.

**Teknoloji profesyonellikle birleşti.**

Technology combined with professionalism.



T SİSTEM DIŞ TORNA KATERLERİ  
T System External Lathe Tool Holders



05

P SİSTEM DIŞ TORNA KATERLERİ  
P System External Lathe Tool Holders



15

C SİSTEM DIŞ TORNA KATERLERİ  
C System External Lathe Tool Holders



26

M SİSTEM DIŞ TORNA KATERLERİ  
M System External Lathe Tool Holders



31

S SİSTEM DIŞ TORNA KATERLERİ  
S System External Lathe Tool Holders



34

TIRTIR ve PUNTALAMA TAKIMLARI  
Centering Tools



49

T SİSTEM DELİK TORNA KATERLERİ  
T System Boring Bars



50

P SİSTEM DELİK TORNA KATERLERİ  
P System Boring Bars



58

M SİSTEM DELİK TORNA KATERLERİ  
M System Boring Bars



63

S SİSTEM DELİK TORNA KATERLERİ  
S System Boring Bars



66

DIŞ ÇAP KANAL AÇMA TAKIMLARI  
External Grooving Toolholders



78

DELİK İÇİ KANAL AÇMA TAKIMLARI  
Internal Grooving Toolholders



91

DIŞ ve İÇ ÇAP DIŞ AÇMA TAKIMLARI  
External and Internal Threading Toolholders



97

S SİSTEM FREZELER  
S System End Mills



100

KÜRE UÇLU PARMAK FREZELER  
Ball Nose End Mills



125

HIZLI İLERLEMELİ SAPLI TARAMALAR  
High Feed End Mills



126

S SİSTEM MODÜLER FREZELER  
S System Modular End Mills



139

T KANAL FREZELER  
T System Milling



160

DİSK FREZELER  
Disc Milling



162

PAH FREZELER  
Chamfering End Mills



163

S SİSTEM HELİSEL FREZELER  
S System Helix End Mills



164

AYARLI KABA DELİK İŞLEME BARALARI  
Adjustable Rough Boring Heads



165

YÜZEY FREZELER  
Face Milling Cutter



166

DEĞİŞKEN UÇLU MATKAPLAR  
Indexable Drills



221

**INDEX**

**Teknoloji profesyonellikle birleŖti**  
Technology combined with professionalism

[www.smoxh.com.tr](http://www.smoxh.com.tr)

## T SİSTEM DIŐ TORNALATERLERİ

T System External Lathe Tool Holders



## Dışçap Tornalama Takım Tutucu kodlamaları / External tool Holder Code System(ISO)

1	2	3	4	5	6	7	8	9
<b>T</b>	<b>D</b>	<b>J</b>	<b>N</b>	<b>R</b>	<b>25</b>	<b>25</b>	<b>M</b>	<b>15</b>
Elmas Sıkma sistemi Clamping system of insert	Elmas şekli Shape of insert	Tutucu Tipi Holder Style	Elmas boşaltma açısı Clearance Angle of Insert	Takım Yönü Hand of Tool	Şaft Yüksekliği Height of Shank	Şaft Genişliği Width of Shank	Takım Boyu Length of tool	Elmas kesme uzunluğu Length of Insert Cutting Edge

### 1 Elmas Sıkma Sistemleri / Clamping Method of Insert

T D J N R 25 25 M15

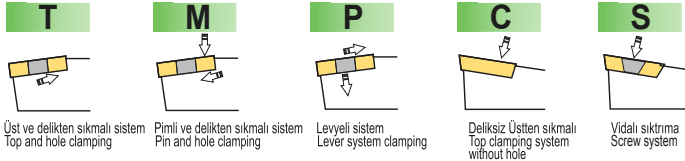

Üst ve delikten sıkılmalı sistem  
Top and hole clamping

Pimli ve delikten sıkılmalı sistem  
Pin and hole clamping

Levye sistemi  
Lever system clamping

Deliksiz Üstten sıkılmalı  
Top clamping system  
without hole

Vidalı sıkıtma  
Screw system

### 3 Tutucu Tipi / Holder Style

T D J N R 25 25 M15

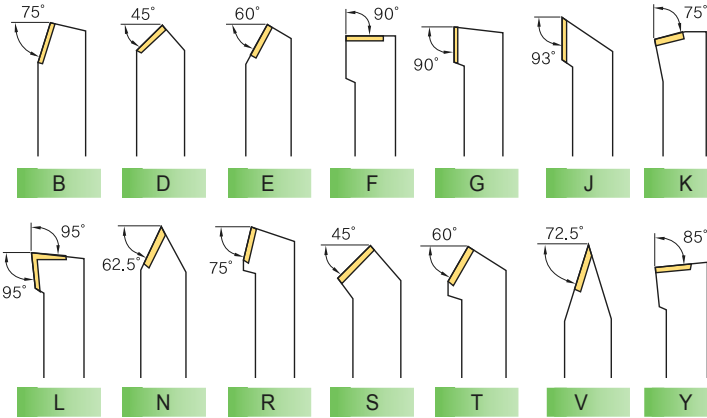

B D E F G J K

L N R S T V Y

### 2 Elmas Şekli / Insert Shape

T D J N R 25 25 M15

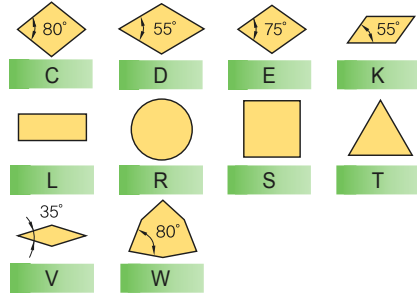

C D E K

L R S T

V W

### 4 Clearance Angle of Insert

T D J N R 25 25 M15

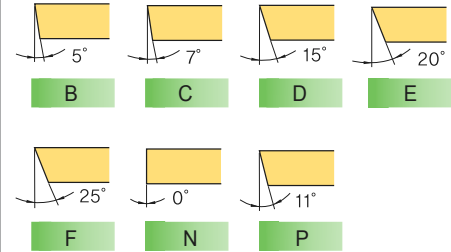

B C D E

F N P

### 5 Takım Yönü / Hand of Tool

T D J N R 25 25 M15

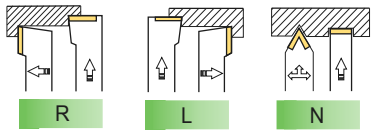

R L N

### 6 Şaft Yüksekliği / Height of Shank

T D J N R 25 25 M15

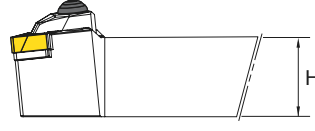

H

### 7 Şaft Genişliği / Width of Shank

T D J N R 25 25 M15



h

### 8 Takım Boyu / Length of Holder

T D J N R 25 25 M15

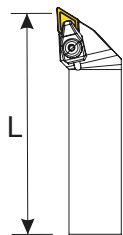

A - 32	H - 100	Q - 180
B - 40	J - 110	R - 200
C - 50	K - 125	S - 250
D - 60	L - 140	T - 300
E - 70	M - 150	U - 350
F - 80	N - 160	V - 400
G - 90	P - 170	W - 450

### 9 Elmas Kesme Uzunluğu / Length of Insert Cutting Edge

T D J N R 25 25 M15

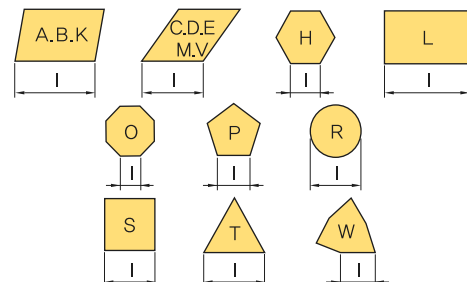

## T SİSTEM DIŞ TORNA KATERLERİ T System External Lathe Tool Holders

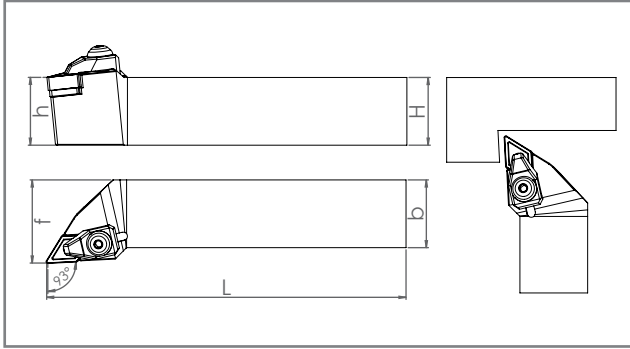



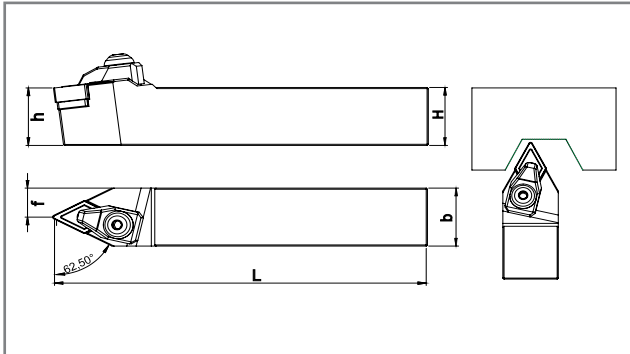





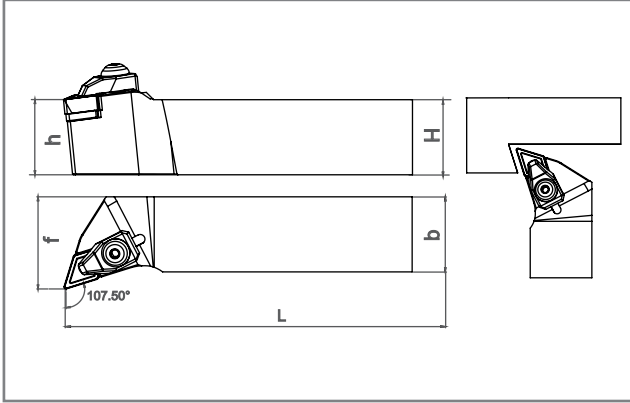

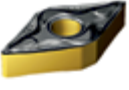







KOD CODE	ÖLÇÜLER DIMENSION (mm)				KESİCİ UÇ INSERT	YEDEK PARÇALAR SPARE PARTS					
	h=H	b	L	f		Baskı Parçası Clamp	Baskı Vidası Screw	Altık Shim	Altık Vidası Shim Screw	Pul Stamp	Anahtar Allen Key
<b>TDJNR/L</b>											
1616 H11	16	16	100	20	DNM.1104..	TSK2 9102	TSBV M5X24 9202	BAX DN11 9601	TSAV M4x10x6 9402	-	AA3
2020 K11	20	20	125	25							
2525 M11	25	25	150	32							
2020 K1504	20	20	125	25	DNM.1504..	TSK1 9101	TSBV M6x30 9205	BAX DN15 9602	TSAV M4x10 9403	TSP 6.5X12 9705	AA3
2525 M1504	25	25	150	32							
3232 P1504	32	32	170	38	DNM.1506..	TSK1 9101	TSBV M6x30 9205	BAX DN15 9602	TSAV M4x10 9403	TSP 6.5X12 9705	AA3
2020 K15	20	20	125	25							
2525 M15	25	25	150	32							
3232 P15	32	32	170	38							
4040 S15	40	40	250	48							











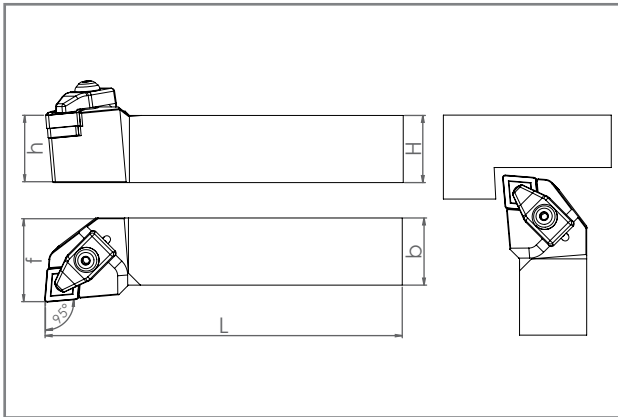













KOD CODE	ÖLÇÜLER DIMENSION (mm)				KESİCİ UÇ INSERT	YEDEK PARÇALAR SPARE PARTS					
	h=H	b	L	f		Baskı Parçası Clamp	Baskı Vidası Screw	Altık Shim	Altık Vidası Shim Screw	Pul Stamp	Anahtar Allen Key
<b>TDNNN</b>											
1616 H11	16	16	100	8	DNM.1104..	TSK2 9102	TSBV M5X24 9202	BAX DN11 9601	TSAV M4x10x6 9402	-	AA3
2020 K11	20	20	125	10							
2525 M11	25	25	150	12.5							
2020 K1504	20	20	125	10	DNM.1504..	TSK1 9101	TSBV M6x30 9205	BAX DN15 9602	TSAV M4x10 9403	TSP 6.5X12 9705	AA3
2525 M1504	25	25	150	12.5							
3232 P1504	32	32	170	16	DNM.1506..	TSK1 9101	TSBV M6x30 9205	BAX DN15 9602	TSAV M4x10 9403	TSP 6.5X12 9705	AA3
2020 K15	20	20	125	10							
2525 M15	25	25	150	12.5							
3232 P15	32	32	170	16							
4040 S15	40	40	250	20							

## T SİSTEM DIŞ TORNA KATERLERİ T System External Lathe Tool Holders

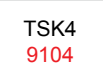

KOD CODE	ÖLÇÜLER DIMENSION (mm)				KESİCİ UÇ INSERT	YEDEK PARÇALAR SPARE PARTS					
	h=H	b	L	f		Baskı Parçası Clamp	Baskı Vidası Screw	Altık Shim	Altık Vidası Shim Screw	Pul Stamp	Anahtar Allen Key
<b>TDHNR/L</b>											
2525 M1504	25	25	150	32	DNM.1504						
3232 P1504	32	32	170	38							
2020 K15	20	20	125	25	DNM.1506						
2525 M15	25	25	150	32							
3232 P15	32	32	170	38							



KOD CODE	ÖLÇÜLER DIMENSION (mm)				KESİCİ UÇ INSERT	YEDEK PARÇALAR SPARE PARTS					
	h=H	b	L	f		Baskı Parçası Clamp	Baskı Vidası Screw	Altık Shim	Altık Vidası Shim Screw	Pul Stamp	Anahtar Allen Key
<b>TCLNR/L</b>											
2020 K12	20	20	125	25	CNM.1204..						
2525 M12	25	25	150	32							
3232 P12	32	32	170	38							
4040 S12	40	40	250	48	CNM.1606..						
2525 M16	25	25	150	32							
3232 P16	32	32	170	38							
4040 S16	40	40	250	48	CNM.1909..						
3232 P19	32	32	170	38							
4040 S19	40	40	250	48							

## T SİSTEM DIŞ TORNA KATERLERİ

### T System External Lathe Tool Holders

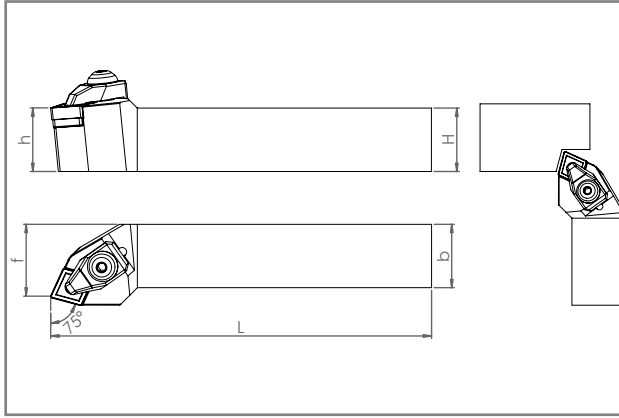

KOD CODE	ÖLÇÜLER DIMENSION (mm)				KESİCİ UÇ INSERT	YEDEK PARÇALAR SPARE PARTS					
	h=H	b	L	f		Baskı Parçası Clamp	Baskı Vidası Screw	Altık Shim	Altık Vidası Shim Screw	Pul Stamp	Anahtar Allen Key
TCKNR/L											
2020 K12	20	20	125	25	CNM.1204..	TSK1 9101	TSBV M6x30 9205	BAX CN12 9603	TSAV M4x10 9403	TSP 6.5X12 9705	AA3
2525 M12	25	25	150	32							
2525 M16	25	25	150	32	CNM.1606..	TSK3 9103	TSBV M6x30x7 9206	BAX CN16 9604	TSAV M6x16x9 9404	-	AA4
3232 P16	32	32	170	38							

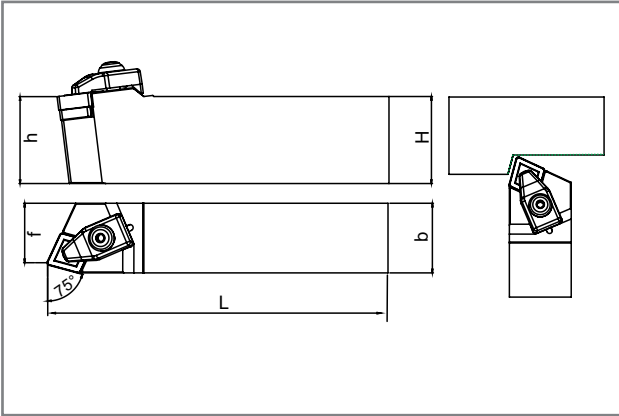





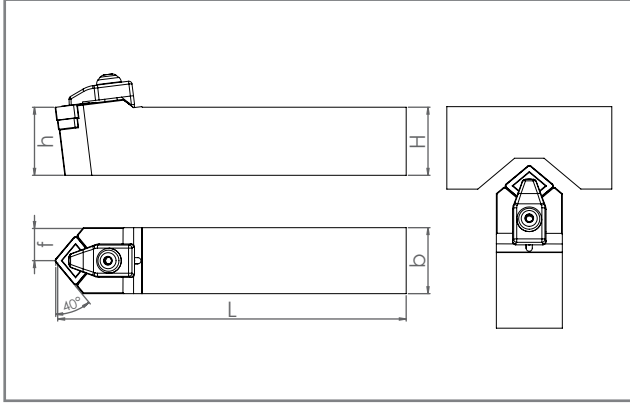

KOD CODE	ÖLÇÜLER DIMENSION (mm)				KESİCİ UÇ INSERT	YEDEK PARÇALAR SPARE PARTS					
	h=H	b	L	f		Baskı Parçası Clamp	Baskı Vidası Screw	Altık Shim	Altık Vidası Shim Screw	Pul Stamp	Anahtar Allen Key
TCBNR/L											
2525 M12	25	25	150	22.5	CNM.1204..	TSK1 9101	TSBV M6x30 9205	BAX CN12 9603	TSAV M4x10 9403	TSP 6.5X12 9705	AA3
2525 M16	25	25	150	22.5							
3232 P19	32	32	170	29.5	CNM.1909..	TSK4 9104	TSBV M8x30 9207	BAX CN16 9604	TSAV M6x16x11 9406	-	AA4

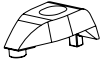





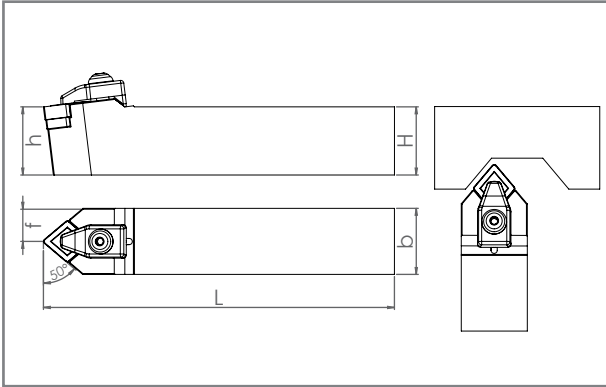

## T SİSTEM DIŞ TORNA KATERLERİ T System External Lathe Tool Holders

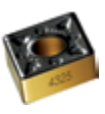







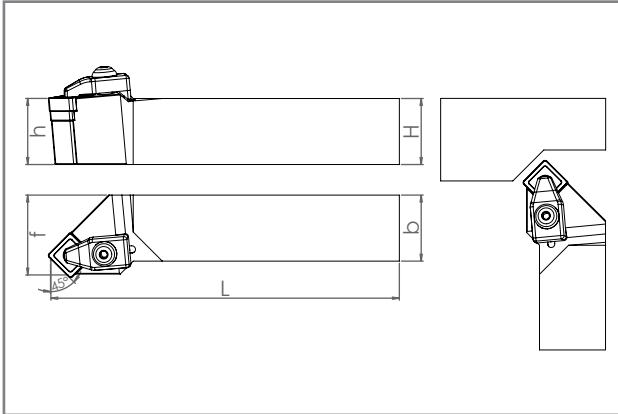

KOD CODE	ÖLÇÜLER DIMENSION (mm)				KESİCİ UÇ INSERT	YEDEK PARÇALAR SPARE PARTS					
	h=H	b	L	f		Baskı Parçası Clamp	Baskı Vidası Screw	Altık Shim	Altık Vidası Shim Screw	Pul Stamp	Anahtar Allen Key
<b>TCZNN</b>											
2020 K12	20	20	125	10	CNM.1204..	TSK1 9101	TSBV M6x30 9205	BAX CN12 9603	TSAV M4x10 9403	TSP 6.5X12 9705	AA3
2525 M12	25	25	150	12.5							
3232 P12	32	32	170	16							
2525 M16	25	25	150	12.5	CNM.1606..	TSK3 9103	TSBV M6x30x7 9206	BAX CN16 9604	TSAV M6x16x9 9404	-	AA4
3232 P16	32	32	170	16							
4040 S16	40	40	250	20							
3232 P19	32	32	170	16	CNM.1909..	TSK4 9104	TSBV M8x30 9207	BAX CN19 9605	TSAV M6x16x11 9406	-	AA4
4040 S19	40	40	250	20							









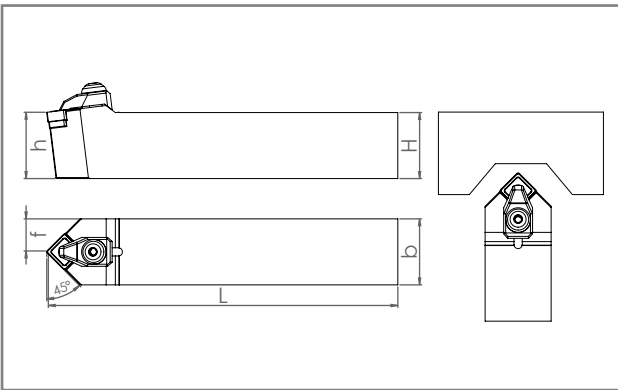

KOD CODE	ÖLÇÜLER DIMENSION (mm)				KESİCİ UÇ INSERT	YEDEK PARÇALAR SPARE PARTS					
	h=H	b	L	f		Baskı Parçası Clamp	Baskı Vidası Screw	Altık Shim	Altık Vidası Shim Screw	Pul Stamp	Anahtar Allen Key
<b>TCMNN</b>											
1616 H12	16	16	100	8	CNM.1204..	TSK1 9101	TSBV M6x30 9205	BAX CN12 9603	TSAV M4x10 9403	TSP 6.5X12 9705	AA3
2020 K12	20	20	125	10							
2525 M12	25	25	150	12.5							
3232 P12	32	32	170	16							
2525 M16	25	25	150	12.5	CNM.1606..	TSK3 9103	TSBV M6x30x7 9206	BAX CN16 9604	TSAV M6x16x9 9404	-	AA4
3232 P16	32	32	170	16							
4040 S16	40	40	250	20							
3232 P19	32	32	170	16	CNM.1909..	TSK4 9104	TSBV M8x30 9207	BAX CN19 9605	TSAV M6x16x11 9406	-	AA4
4040 S19	40	40	250	20							

## T SİSTEM DIŞ TORNA KATERLERİ T System External Lathe Tool Holders









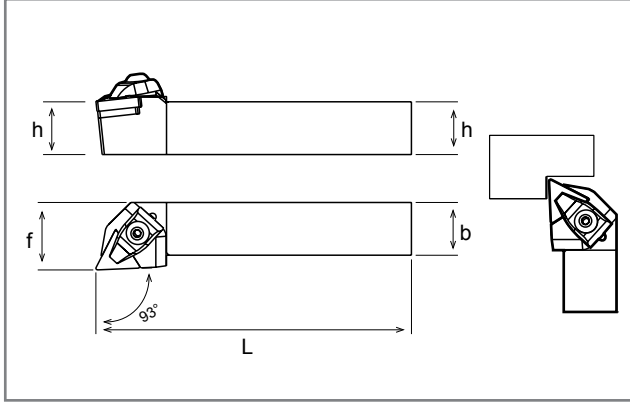

KOD CODE	ÖLÇÜLER DIMENSION (mm)				KESİCİ UÇ INSERT	YEDEK PARÇALAR SPARE PARTS					
	h=H	b	L	f		Baskı Parçası Clamp	Baskı Vidası Screw	Altık Shim	Altık Vidası Shim Screw	Pul Stamp	Anahtar Allen Key
TSSNR/L											
2020 K12	20	20	125	25	SNM.1204..	TSK1 9101	TSBV M6x30 9205	BAX SN12 9608	TSAV M4x10 9403	TSP 6.5X12 9705	AA3
2525 M12	25	25	150	32							
3232 P12	32	32	170	38							
2525 M15	25	25	150	32	SNM.1506..	TSK3 9103	TSBV M6x30x7 9206	BAX SN15 9609	TSAV M6x16x10 9405	-	AA4
3232 P15	32	32	170	38							
4040 S15	40	40	250	48							
3232 P19	32	32	170	38	SNM.1906..	TSK4 9104	TSBV M8x30 9207	BAX SN19 9622	TSAV M6x16x11 9406	-	AA4
4040 S19	40	40	250	48							









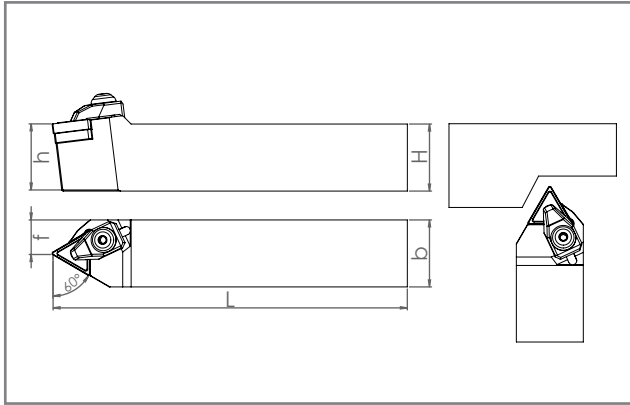

KOD CODE	ÖLÇÜLER DIMENSION (mm)				KESİCİ UÇ INSERT	YEDEK PARÇALAR SPARE PARTS					
	h=H	b	L	f		Baskı Parçası Clamp	Baskı Vidası Screw	Altık Shim	Altık Vidası Shim Screw	Pul Stamp	Anahtar Allen Key
TSDNN											
2020 K12	20	20	125	10	SNM.1204..	TSK1 9101	TSBV M6x30 9205	BAX SN12 9608	TSAV M4x10 9403	TSP 6.5X12 9705	AA3
2525 M12	25	25	150	12.5							
3232 P12	32	32	170	16							
2525 M15	25	25	150	12.5	SNM.1506..	TSK3 9103	TSBV M6x30x7 9206	BAX SN15 9609	TSAV M6x16x9 9404	-	AA4
3232 P15	32	32	170	16							
4040 S15	40	40	250	20							

## T SİSTEM DIŞ TORNA KATERLERİ T System External Lathe Tool Holders



KOD CODE	ÖLÇÜLER DIMENSION (mm)				KESİCİ UÇ INSERT	YEDEK PARÇALAR SPARE PARTS					
	h=H	b	L	f		Baskı Parçası Clamp	Baskı Vidası Screw	Altık Shim	Altık Vidası Shim Screw	Pul Stamp	Anahtar Allen Key
<b>TTJNR/L</b>											
2020 K16	20	20	125	25	TNM.1604..	TSK2 9102	TSBV M5x24 9202	BAX TN16 9610	TSAV M4x10x6 9402	-	AA3
2525 M16	25	25	150	32							
3232 P16	32	32	170	38							
2525 M22	25	25	150	32	TNM.2204..	TSK1 9101	TSBV M6x30 9205	BAX TN22 9611	TSAV M4x10 9403	TSP 6.5X12 9705	
3232 P22	32	32	170	38							
4040 S22	40	40	250	48							



KOD CODE	ÖLÇÜLER DIMENSION (mm)				KESİCİ UÇ INSERT	YEDEK PARÇALAR SPARE PARTS					
	h=H	b	L	f		Baskı Parçası Clamp	Baskı Vidası Screw	Altık Shim	Altık Vidası Shim Screw	Pul Stamp	Anahtar Allen Key
<b>TTENN</b>											
2020 K16	20	20	125	10	TNM.1604..	TSK2 9102	TSBV M5x24 9202	BAX TN16 9610	TSAV M4x10x6 9402	-	AA3
2525 M16	25	25	150	12.5							
3232 P16	32	32	170	16							
2525 M22	25	25	150	12.5	TNM.2204..	TSK1 9101	TSBV M6x30 9205	BAX TN22 9611	TSAV M4x10 9403	TSP 6.5X12 9705	
3232 P22	32	32	170	16							
4040 S22	40	40	250	20							

## T SİSTEM DIŞ TORNA KATERLERİ T System External Lathe Tool Holders

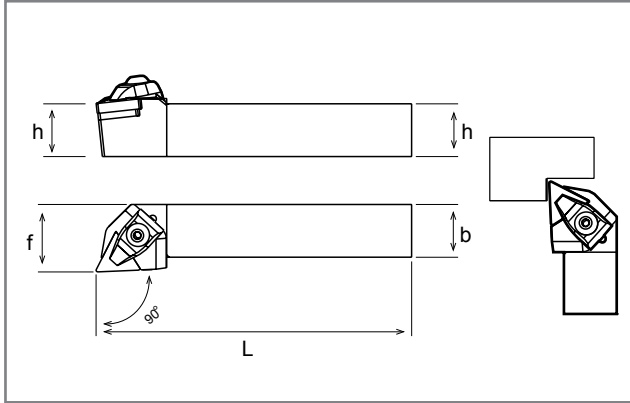



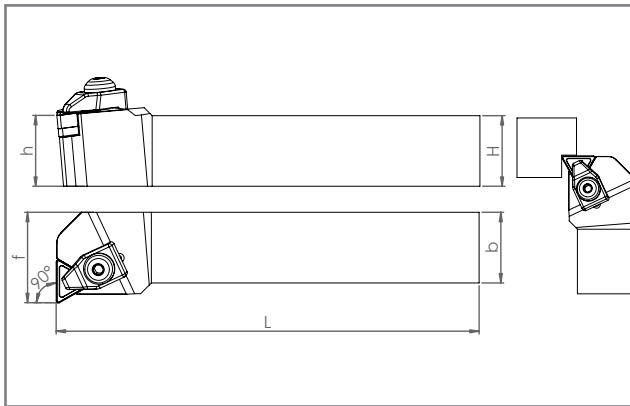



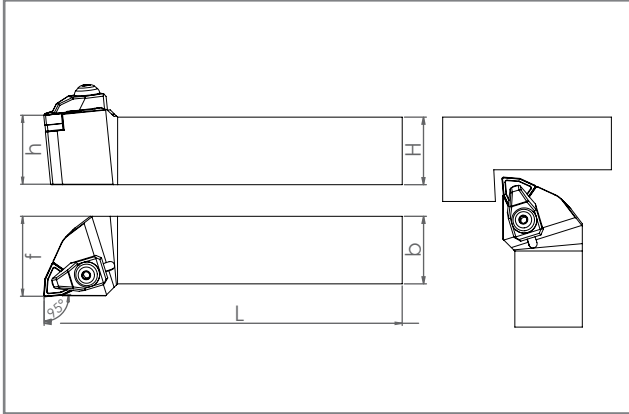

KOD CODE	ÖLÇÜLER DIMENSION (mm)				KESİCİ UÇ INSERT	YEDEK PARÇALAR SPARE PARTS					
	h=H	b	L	f		Baskı Parçası Clamp	Baskı Vidası Screw	Altık Shim	Altık Vidası Shim Screw	Pul Stamp	Anahtar Allen Key
<b>TTGNR/L</b>											
2020 K16	20	20	125	25	TNM.1604..	TSK2 9102	TSBV M5x24 9202	BAX TN16 9610	TSAV M4x10x6 9402	-	AA3
2525 M16	25	25	150	32							
3232 P16	32	32	170	38							
2525 M22	25	25	150	32	TNM.2204..	TSK1 9101	TSBV M6x30 9205	BAX TN22 9611	TSAV M4x10 9403	TSP 6.5X12 9705	AA3
3232 P22	32	32	170	38							
4040 S22	40	40	250	48							









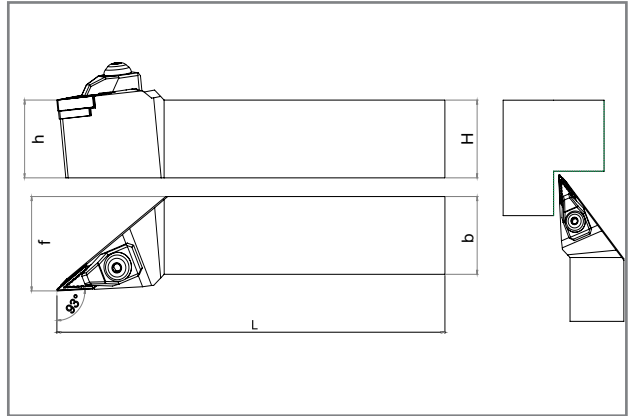

KOD CODE	ÖLÇÜLER DIMENSION (mm)				KESİCİ UÇ INSERT	YEDEK PARÇALAR SPARE PARTS					
	h=H	b	L	f		Baskı Parçası Clamp	Baskı Vidası Screw	Altık Shim	Altık Vidası Shim Screw	Pul Stamp	Anahtar Allen Key
<b>TTFNR/L</b>											
2020 K16	20	20	125	25	TNM.1604..	TSK2 9102	TSBV M5x24 9202	BAX TN16 9610	TSAV M4x10x6 9402	-	AA3
2525 M16	25	25	150	32							
3232 P16	32	32	170	38							
2525 M22	25	25	150	32	TNM.2204..	TSK1 9101	TSBV M6x30 9205	BAX TN22 9611	TSAV M4x10 9403	TSP 6.5X12 9705	AA3
3232 P22	32	32	170	38							
4040 S22	40	40	250	48							

## T SİSTEM DIŞ TORNA KATERLERİ T System External Lathe Tool Holders









KOD CODE	ÖLÇÜLER DIMENSION (mm)				KESİCİ UÇ INSERT	YEDEK PARÇALAR SPARE PARTS					
	h=H	b	L	f		Baskı Parçası Clamp	Baskı Vidası Screw	Altlık Shim	Altlık Vidası Shim Screw	Pul Stamp	Anahtar Allen Key
<b>TWLNR/L</b>											
1616 H06	16	16	100	20	WNM.0604..	TSK2 9102	TSBV M5x24 9202	BAX WN06 9606	CSAV M3x10 9401	-	AA3
2020 K06	20	20	125	25							
2525 M06	25	25	150	32							
2020 K08	20	20	125	25	WNM.0804..	TSK1 9101	TSBV M6x30 9205	BAX WN08 9607	TSAV M4x10 9403	TSP 6.5X12 9705	AA3
2525 M08	25	25	150	32							
3232 P08	32	32	170	38							
4040 S08	40	40	250	48							

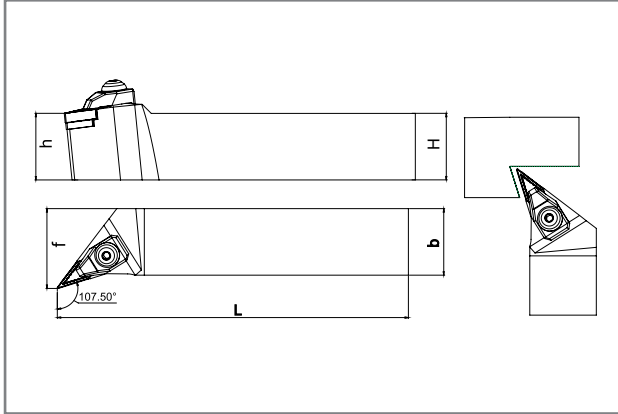









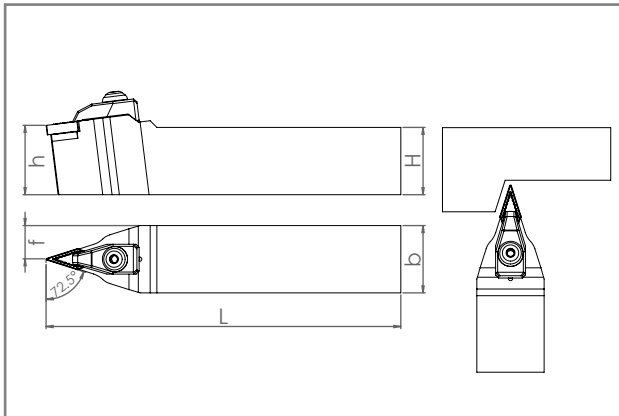





KOD CODE	ÖLÇÜLER DIMENSION (mm)				KESİCİ UÇ INSERT	YEDEK PARÇALAR SPARE PARTS					
	h=H	b	L	f		Baskı Parçası Clamp	Baskı Vidası Screw	Altlık Shim	Altlık Vidası Shim Screw	Pul Stamp	Anahtar Allen Key
<b>TVJNR/L</b>											
2020 K16	20	20	125	25	VNM.1604..	TSK5 9105	TSBV M6x25 9203	BAX VN16 9612	TSAV M4x10x6 9402	TSP 6.5X12 9705	AA3
2525 M16	25	25	150	32			TSBV M6x30 9205				
3232 P16	32	32	170	38							
4040 S16	40	40	250	48							

## T SİSTEM DIŞ TORNA KATERLERİ T System External Lathe Tool Holders









KOD CODE	ÖLÇÜLER DIMENSION (mm)				KESİCİ UÇ INSERT	YEDEK PARÇALAR SPARE PARTS					
	h=H	b	L	f		Baskı Parçası Clamp	Baskı Vidası Screw	Altık Shim	Altık Vidası Shim Screw	Pul Stamp	Anahtar Allen Key
TVHNR/L											
2020 K16	20	20	125	25	VNM.1604..						
2525 M16	25	25	150	32							
3232 P16	32	32	170	38							

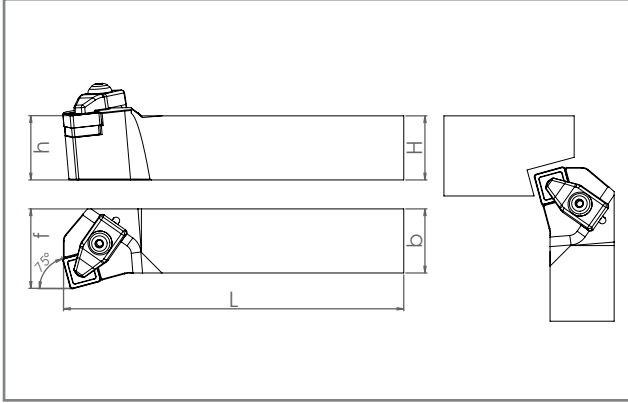

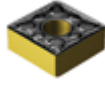
KOD CODE	ÖLÇÜLER DIMENSION (mm)				KESİCİ UÇ INSERT	YEDEK PARÇALAR SPARE PARTS					
	h=H	b	L	f		Baskı Parçası Clamp	Baskı Vidası Screw	Altık Shim	Altık Vidası Shim Screw	Pul Stamp	Anahtar Allen Key
TVVNN											
2020 K16	20	20	125	10	VNM.1604..						
2525 M16	25	25	150	12.5							
3232 P16	32	32	170	16							
4040 S16	40	40	250	20							

## T SİSTEM DIŞ TORNA KATERLERİ T System External Lathe Tool Holders



KOD CODE	ÖLÇÜLER DIMENSION (mm)				KESİCİ UÇ INSERT	YEDEK PARÇALAR SPARE PARTS					
	h=H	b	L	f		Baskı Parçası Clamp	Baskı Vidası Screw	Altık Shim	Altık Vidası Shim Screw	Pul Stamp	Anahtar Allen Key
TSKNR/L											
2020 K12	20	20	125	25	SNM.1204..	TSK1 9101	TSBV M6x30 9205	BAX SN12 9608	TSAV M4x10 9403	TSP 6.5X12 9705	AA3
2525 M12	25	25	150	32							
3232 P12	32	32	170	38							
2525 M15	25	25	150	32	SNM.1508..	TSK3 9103	TSBV M6x30x7 9206	BAX SN15 9609	TSAV M6x16x9 9404	-	AA4
3232 P15	32	32	170	38							

**Teknoloji profesyonellikle birleŖti**  
Technology combined with professionalism

[www.smoxx.com.tr](http://www.smoxx.com.tr)

## **P SİSTEM DIŐ TORNA KATERLERİ**









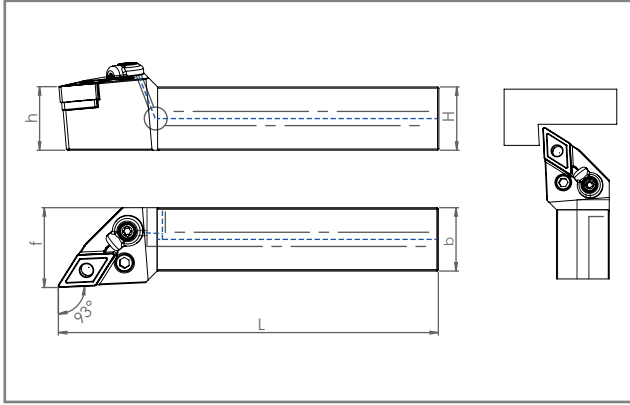

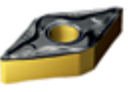
P System External Lathe Tool Holders











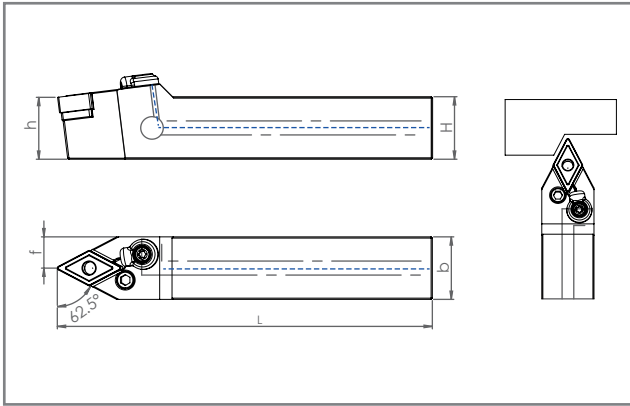

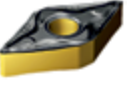

## P SİSTEM DIŞ TORNA KATERLERİ P System External Lathe Tool Holders



KOD CODE	ÖLÇÜLER DIMENSION (mm)				KESİCİ UÇ INSERT	YEDEK PARÇALAR SPARE PARTS										
	h=H	b	L	f		Levyeye Lever	Levyeye Vidası Lever Screw	Altılık Shim	Soğutma Ünitesi Cooling Unit	Kep Vidası Clamp Screw	Tıpa Plug	Soğutma Rakoru Fitting	Altılık Yayı Shim Spring	Tork Anahtar Torx Key	Anahtar Allen Key	
PDJNR/L-PH	h=H	b	L	f												
2020 K15-PH	20	20	125	25	DNM.1506..	SPL4 9123	SLV2 M8x21 9225	BAX DN15 9602	PSK1 9224	SSV M3x10 9511	PHSV M8.1x6 9320	RKR1 M8x1 9321	SLAY1 9701	T15	AA3	
2525 M15-PH	25	25	150	32		SPL4 9123	SLV2 M8x21 9225	BAX DN15 9602	PSK1 9224	SSV M3x10 9511	PHSV M8.1x6 9320	RKR1 M8x1 9321	SLAY1 9701	T15	AA3	
3232 P15-PH	32	32	170	38		SPL4 9123	SLV2 M8x21 9225	BAX DN15 9602	PSK1 9224	SSV M3x10 9511	PHSV M8.1x6 9320	RKR1 M8x1 9321	SLAY1 9701	T15	AA3	



KOD CODE	ÖLÇÜLER DIMENSION (mm)				KESİCİ UÇ INSERT	YEDEK PARÇALAR SPARE PARTS										
	h=H	b	L	f		Levyeye Lever	Levyeye Vidası Lever Screw	Altılık Shim	Soğutma Ünitesi Cooling Unit	Kep Vidası Clamp Screw	Tıpa Plug	Soğutma Rakoru Fitting	Altılık Yayı Shim Spring	Tork Anahtar Torx Key	Anahtar Allen Key	
PDNNN-PH	h=H	b	L	f												
2020 K15-PH	20	20	125	10	DNM.1506..	SPL4 9123	SLV2 M8x21 9225	BAX DN15 9602	PSK1 9224	SSV M3x10 9511	PHSV M8.1x6 9320	RKR1 M8x1 9321	SLAY1 9701	T15	AA3	
2525 M15-PH	25	25	150	12.5		SPL4 9123	SLV2 M8x21 9225	BAX DN15 9602	PSK1 9224	SSV M3x10 9511	PHSV M8.1x6 9320	RKR1 M8x1 9321	SLAY1 9701	T15	AA3	
3232 P15-PH	32	32	170	16		SPL4 9123	SLV2 M8x21 9225	BAX DN15 9602	PSK1 9224	SSV M3x10 9511	PHSV M8.1x6 9320	RKR1 M8x1 9321	SLAY1 9701	T15	AA3	

## P SİSTEM DIŞ TORNA KATERLERİ P System External Lathe Tool Holders

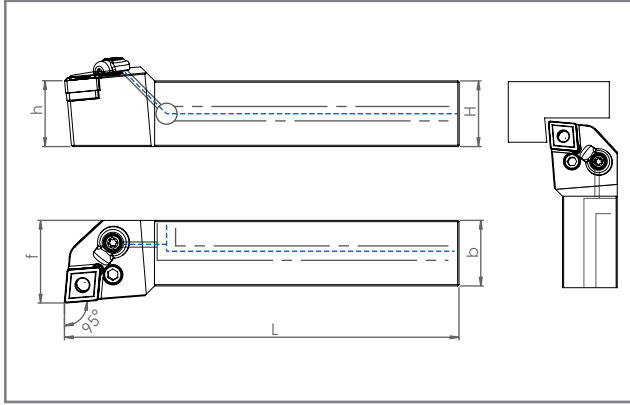



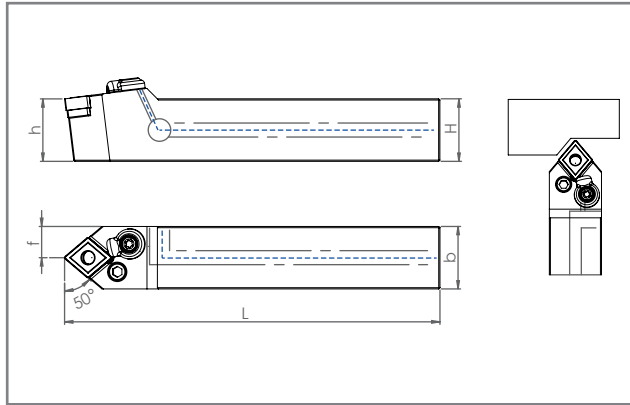





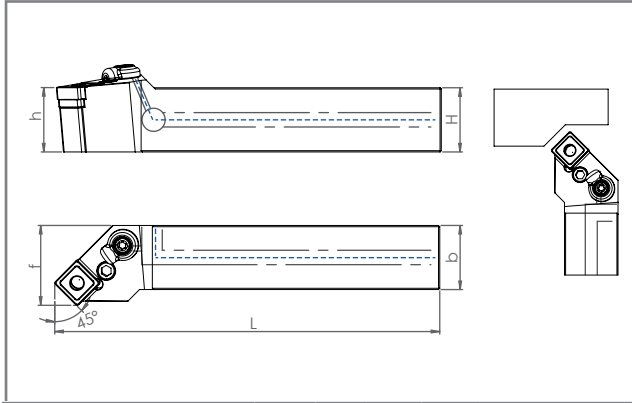



KOD CODE	ÖLÇÜLER DIMENSION (mm)				KESİCİ UÇ INSERT	YEDEK PARÇALAR SPARE PARTS									
	h=H	b	L	f		Levye Lever	Levye Vidası Lever Screw	Altılık Shim	Soğutma Unitesi Cooling Unit	Kep Vidası Clamp Screw	Tıpa Plug	Soğutma Rakoru Fitting	Altılık Yayı Shim Spring	Tork Anahtar Torx Key	Anahtar Allen Key
<b>PCLNR/L-PH</b>															
2020 K12-PH	20	20	125	25	CNM.1204..	SPL1 9120	SLV1 M8x19 9224	BAX CN12 9603	PSK1 9224	SSV M3x10 9511	PHSV M8.1x6 9320	RKR1 M8x1 9321	SLAY1 9701	T15	AA3
2525 M12-PH	25	25	150	32									SLAY2 9702		
3232 P12-PH	32	32	170	38	CNM.1606..	SPL2 9121	SLV2 M8x21 9225	BAX CN16 9604	PSK1 9224	SSV M3x10 9511	PHSV M8.1x6 9320	RKR1 M8x1 9321	SLAY2 9702	T15	AA3
2525 M16-PH	25	25	150	32									SLAY3 9703		
3232 P16-PH	32	32	170	38	CNM.1906..	SPL3 9122	SLV3 M10x28 9226	BAX CN19 9605	PSK1 9224	SSV M3x10 9511	PHSV M8.1x6 9320	RKR1 M8x1 9321	SLAY3 9703	T15	AA4
3232 P19-PH	32	32	170	38									AA4		











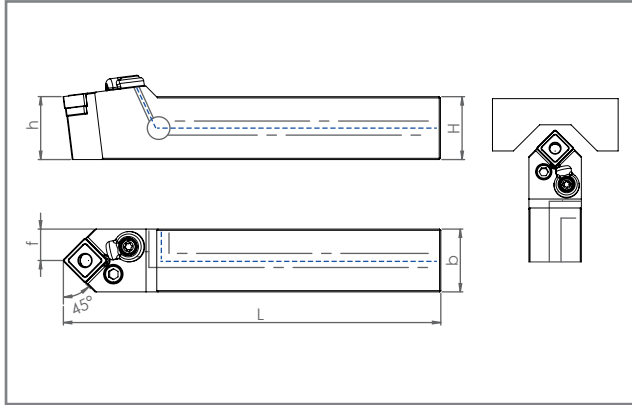



KOD CODE	ÖLÇÜLER DIMENSION (mm)				KESİCİ UÇ INSERT	YEDEK PARÇALAR SPARE PARTS									
	h=H	b	L	f		Levye Lever	Levye Vidası Lever Screw	Altılık Shim	Soğutma Unitesi Cooling Unit	Kep Vidası Clamp Screw	Tıpa Plug	Soğutma Rakoru Fitting	Altılık Yayı Shim Spring	Tork Anahtar Torx Key	Anahtar Allen Key
<b>PCMNN-PH</b>															
2020 K12-PH	20	20	125	10	CNM.1204..	SPL1 9120	SLV1 M8x19 9224	BAX CN12 9603	PSK1 9224	SSV M3x10 9511	PHSV M8.1x6 9320	RKR1 M8x1 9321	SLAY1 9701	T15	AA3
2525 M12-PH	25	25	150	12.5									SLAY2 9702		
3232 P12-PH	32	32	170	16	CNM.1606..	SPL2 9121	SLV2 M8x21 9225	BAX CN16 9604	PSK1 9224	SSV M3x10 9511	PHSV M8.1x6 9320	RKR1 M8x1 9321	SLAY2 9702	T15	AA3
2525 M16-PH	25	25	150	12.5									SLAY3 9703		
3232 P16-PH	32	32	170	16	CNM.1906..	SPL3 9122	SLV3 M10x28 9226	BAX CN19 9605	PSK1 9224	SSV M3x10 9511	PHSV M8.1x6 9320	RKR1 M8x1 9321	SLAY3 9703	T15	AA4
3232 P19-PH	32	32	170	16									AA4		

## P SİSTEM DIŞ TORNA KATERLERİ P System External Lathe Tool Holders



KOD CODE	ÖLÇÜLER DIMENSION (mm)				KESİCİ UÇ INSERT	YEDEK PARÇALAR SPARE PARTS									
	h=H	b	L	f		Levye Lever	Levye Vidası Lever Screw	Altık Shim	Soğutma Ünitesi Cooling Unit	Kep Vidası Clamp Screw	Tıpa Plug	Soğutma Rakoru Fitting	Altık Yayı Shim Spring	Tork Anahtar Torx Key	Anahtar Allen Key
PSSNR/L-PH															
2020 K12-PH	20	20	125	25	SNM.1204..	SPL1 9120	SLV1 M8x19 9224	BAX SN12 9608	PSK1 9224	SSV M3x10 9511	PHSV M8.1x6 9320	RKR1 M8x1 9321	SLAY1 9701	T15	AA3
2525 M12-PH	25	25	150	32									SLAY2 9702		
3232 P12-PH	32	32	170	38									SLAY3 9703		
3232 P15-PH	32	32	170	38	SNM.1506..	SPL2 9121	SLV2 M8x21 9225	BAX SN15 9609							
3232 P19-PH	32	32	170	38	SNM.1906	SPL3 9122	SLV3 M10x28 9226	BAX SN19 9629							AA4



KOD CODE	ÖLÇÜLER DIMENSION (mm)				KESİCİ UÇ INSERT	YEDEK PARÇALAR SPARE PARTS									
	h=H	b	L	f		Levye Lever	Levye Vidası Lever Screw	Altık Shim	Soğutma Ünitesi Cooling Unit	Kep Vidası Clamp Screw	Tıpa Plug	Soğutma Rakoru Fitting	Altık Yayı Shim Spring	Tork Anahtar Torx Key	Anahtar Allen Key
PSDNN-PH															
2020 K12-PH	20	20	125	10	SNM.1204..	SPL1 9120	SLV1 M8x19 9224	BAX SN12 9608	PSK1 9224	SSV M3x10 9511	PHSV M8.1x6 9320	RKR1 M8x1 9321	SLAY1 9701	T15	AA3
2525 M12-PH	25	25	150	12.5									SLAY2 9702		
3232 P12-PH	32	32	170	16									SLAY3 9703		
2525 M15-PH	25	25	150	12.5	SNM.1506..	SPL2 9121	SLV2 M8x21 9225	BAX SN15 9609							
3232 P15-PH	32	32	170	16	SNM.1906..	SPL3 9122	SLV3 M10x28 9226	BAX SN19 9629							AA4

## P SİSTEM DIŞ TORNA KATERLERİ P System External Lathe Tool Holders

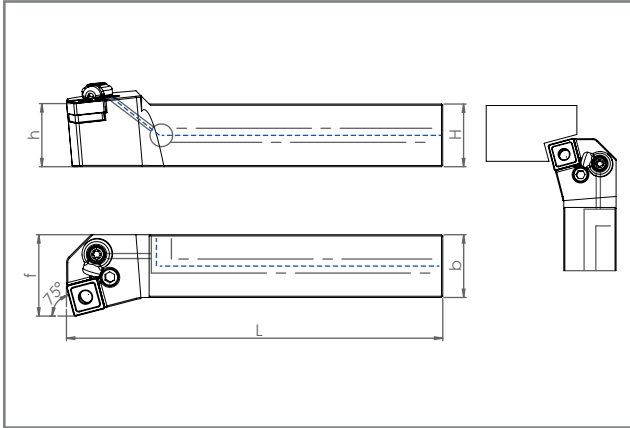



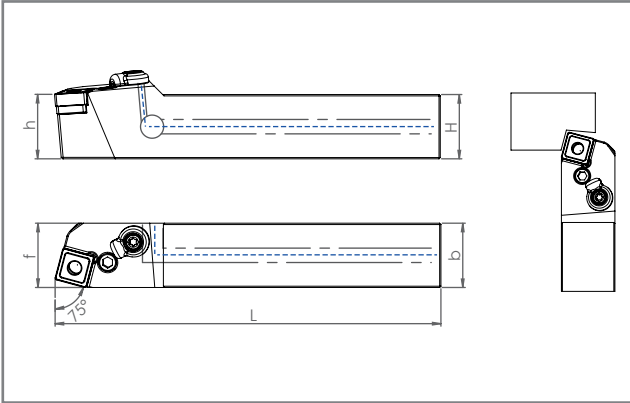





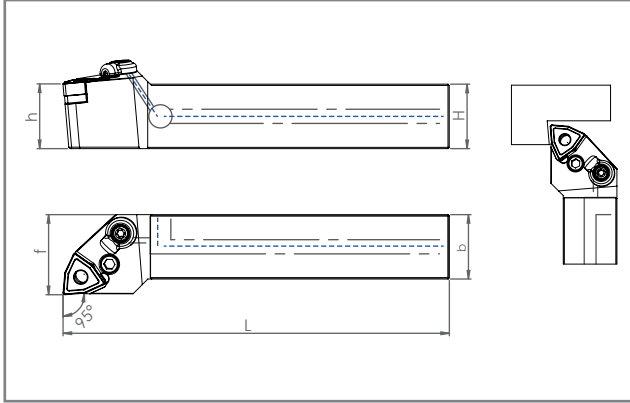



KOD CODE	ÖLÇÜLER DIMENSION (mm)				KESİCİ UÇ INSERT	YEDEK PARÇALAR SPARE PARTS									
	h=H	b	L	f		Levyeye Lever	Levyeye Vidası Lever Screw	Altılık Shim	Soğutma Ünitesi Cooling Unit	Kep Vidası Clamp Screw	Tıpa Plug	Soğutma Rakoru Fitting	Altılık Yayı Shim Spring	Tork Anahtar Torx Key	Anahtar Allen Key
PSKNR/L-PH	h=H	b	L	f											
2020 K12-PH	20	20	125	25	SNM.1204..	SPL1 9120	SLV1 M8x19 9224	BAX SN12 9608	PSK1 9224	SSV M3x10 9511	PHSV M8.1x6 9320	RKR1 M8x1 9321	SLAY1 9701	T15	AA3
2525 M12-PH	25	25	150	32		SPL2 9121	SLV2 M8x21 9225	BAX SN15 9609					SLAY2 9702		
3232 P12-PH	32	32	170	38		SPL3 9122	SLV3 M10x28 9226	BAX SN19 9629					SLAY3 9703		
2525 M15-PH	25	25	150	32	SNM.1506..	SPL2 9121	SLV2 M8x21 9225	BAX SN15 9609	PSK1 9224	SSV M3x10 9511	PHSV M8.1x6 9320	RKR1 M8x1 9321	SLAY2 9702	T15	AA3
3232 P15-PH	32	32	170	38		SPL3 9122	SLV3 M10x28 9226	BAX SN19 9629					SLAY3 9703		
3232 P19-PH	32	32	170	38	SNM.1906..	SPL3 9122	SLV3 M10x28 9226	BAX SN19 9629					SLAY3 9703		AA4











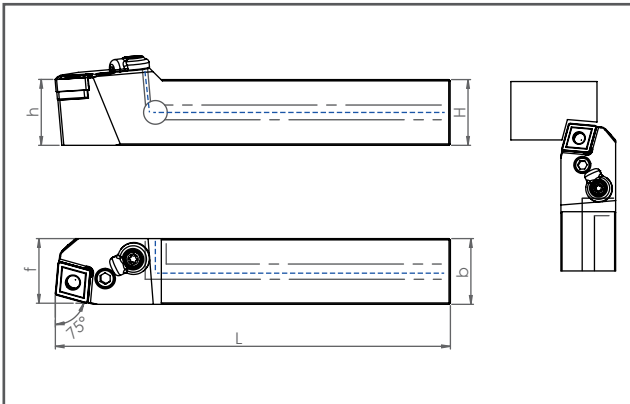



KOD CODE	ÖLÇÜLER DIMENSION (mm)				KESİCİ UÇ INSERT	YEDEK PARÇALAR SPARE PARTS									
	h=H	b	L	f		Levyeye Lever	Levyeye Vidası Lever Screw	Altılık Shim	Soğutma Ünitesi Cooling Unit	Kep Vidası Clamp Screw	Tıpa Plug	Soğutma Rakoru Fitting	Altılık Yayı Shim Spring	Tork Anahtar Torx Key	Anahtar Allen Key
PSBNR/L-PH	h=H	b	L	f											
2020 K12-PH	20	20	125	17	SNM.1204..	SPL1 9120	SLV1 M8x19 9224	BAX SN12 9608	PSK1 9224	SSV M3x10 9511	PHSV M8.1x6 9320	RKR1 M8x1 9321	SLAY1 9701	T15	AA3
2525 M12-PH	25	25	150	22		SPL2 9121	SLV2 M8x21 9225	BAX SN15 9609					SLAY2 9702		
3232 P12-PH	32	32	170	27		SPL3 9122	SLV3 M10x28 9226	BAX SN19 9629					SLAY3 9703		
3232 P15-PH	32	32	170	27	SNM.1506..	SPL2 9121	SLV2 M8x21 9225	BAX SN15 9609	PSK1 9224	SSV M3x10 9511	PHSV M8.1x6 9320	RKR1 M8x1 9321	SLAY2 9702	T15	AA3
3232 P19-PH	32	32	170	27		SPL3 9122	SLV3 M10x28 9226	BAX SN19 9629					SLAY3 9703		
3232 P19-PH	32	32	170	27	SNM.1906..	SPL3 9122	SLV3 M10x28 9226	BAX SN19 9629					SLAY3 9703		AA4

## P SİSTEM DIŞ TORNA KATERLERİ P System External Lathe Tool Holders









KOD CODE	ÖLÇÜLER DIMENSION (mm)				KESİCİ UÇ INSERT	YEDEK PARÇALAR SPARE PARTS										
	h=H	b	L	f		Levyeye Lever	Levyeye Vidası Lever Screw	Altılık Shim	Soğutma Ünitesi Cooling Unit	Kep Vidası Clamp Screw	Tıpa Plug	Soğutma Rakoru Fitting	Altılık Yayı Shim Spring	Tork Anahtar Torx Key	Anahtar Allen Key	
PWLNR/L-PH	h=H	b	L	f												
2020 K08-PH	20	20	125	25	WNM.0804..	SPL1 9120	SLV1 M8x19 9224	BAX WN08 9607	PSK1 9224	SSV M3x10 9511	PHSV M8.1x6 9320	RKR1 M8x1 9321	SLAY1 9701	T15	AA3	
2525 M08-PH	25	25	150	32		SPL1 9120	SLV1 M8x19 9224	BAX WN08 9607	PSK1 9224	SSV M3x10 9511	PHSV M8.1x6 9320	RKR1 M8x1 9321	SLAY1 9701	T15	AA3	
3232 P08-PH	32	32	170	38		SPL1 9120	SLV1 M8x19 9224	BAX WN08 9607	PSK1 9224	SSV M3x10 9511	PHSV M8.1x6 9320	RKR1 M8x1 9321	SLAY1 9701	T15	AA3	

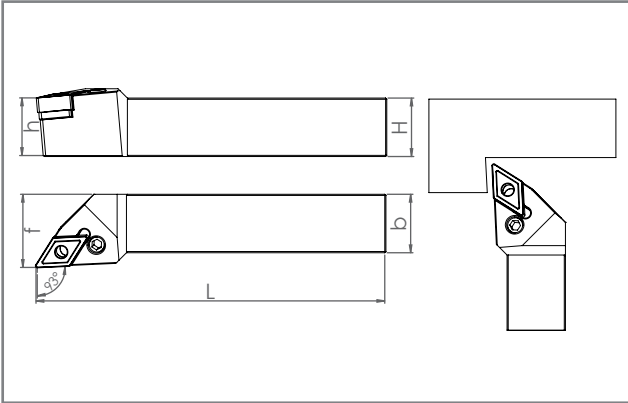





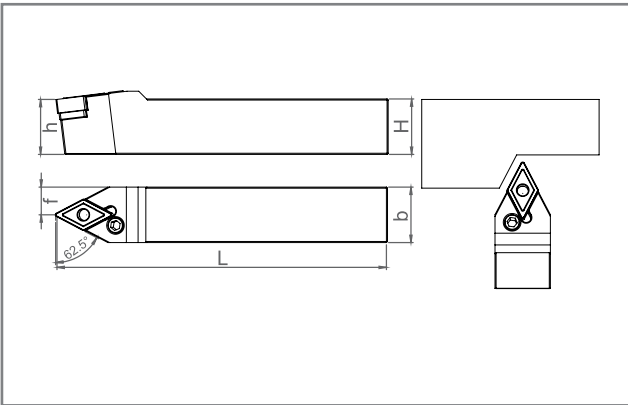

KOD CODE	ÖLÇÜLER DIMENSION (mm)				KESİCİ UÇ INSERT	YEDEK PARÇALAR SPARE PARTS										
	h=H	b	L	f		Levyeye Lever	Levyeye Vidası Lever Screw	Altılık Shim	Soğutma Ünitesi Cooling Unit	Kep Vidası Clamp Screw	Tıpa Plug	Soğutma Rakoru Fitting	Altılık Yayı Shim Spring	Tork Anahtar Torx Key	Anahtar Allen Key	
PCBNR/L-PH	h=H	b	L	f												
2020 K12-PH	20	20	125	17.5	CNM.1204..	SPL1 9120	SLV1 M8x19 9224	BAX CN12 9603	PSK1 9224	SSV M3x10 9511	PHSV M8.1x6 9320	RKR1 M8x1 9321	SLAY1 9701	T15	AA3	
2525 M12-PH	25	25	150	22.5		SPL1 9120	SLV1 M8x19 9224	BAX CN12 9603					SLAY1 9701			
3232 P12-PH	32	32	170	27.5		SPL1 9120	SLV1 M8x19 9224	BAX CN12 9603					SLAY1 9701			
3232 P16-PH	32	32	170	27	CNM.1606..	SPL2 9121	SLV2 M8x21 9225	BAX CN16 9604	PSK1 9224	SSV M3x10 9511	PHSV M8.1x6 9320	RKR1 M8x1 9321	SLAY2 9702	T15	AA3	
3232 P19-PH	32	32	170	27	CNM.1906..	SPL3 9122	SLV3 M10x28 9226	BAX CN19 9605	PSK1 9224	SSV M3x10 9511	PHSV M8.1x6 9320	RKR1 M8x1 9321	SLAY3 9703	T15	AA4	

## P SİSTEM DIŞ TORNA KATERLERİ P System External Lathe Tool Holders

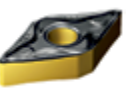







KOD CODE	ÖLÇÜLER DIMENSION (mm)				KESİCİ UÇ INSERT	YEDEK PARÇALAR SPARE PARTS				
	h=H	b	L	f		Levyeye Lever	Levyeye Vidası Lever Screw	Altık Shim	Altık Yayı Shim Spring	Anahtar Allen Key
<b>PDJNR/L</b>										
2020 K15	20	20	125	25	DNM.1506..	SPL4 9123	SLV2 M8x21 9225	BAX DN15 9602	SLAY1 9701	AA3
2525 M15	25	25	150	32						
3232 P15	32	32	170	38						
4040 S15	40	40	250	48						

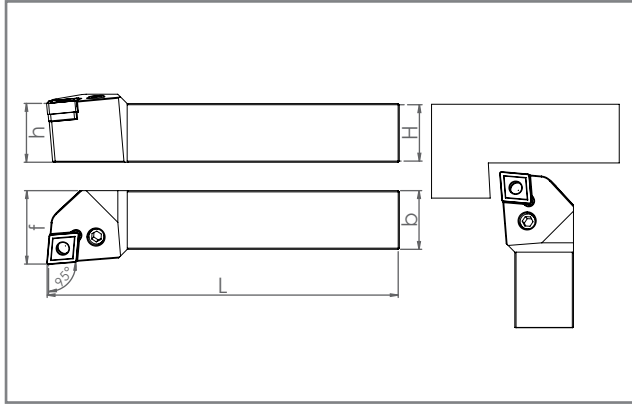





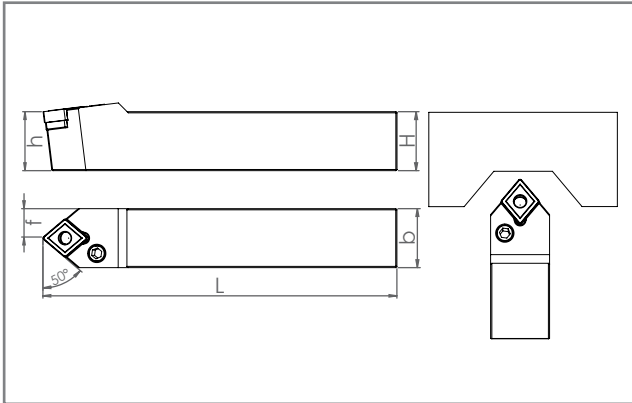

KOD CODE	ÖLÇÜLER DIMENSION (mm)				KESİCİ UÇ INSERT	YEDEK PARÇALAR SPARE PARTS				
	h=H	b	L	f		Levyeye Lever	Levyeye Vidası Lever Screw	Altık Shim	Altık Yayı Shim Spring	Anahtar Allen Key
<b>PDNNN</b>										
2020 K15	20	20	125	10	DNM.1506..	SPL4 9123	SLV2 M8x21 9225	BAX DN15 9602	SLAY1 9701	AA3
2525 M15	25	25	150	12.5						
3232 P15	32	32	170	16						
4040 S15	40	40	250	20						

## P SİSTEM DIŞ TORNA KATERLERİ P System External Lathe Tool Holders



KOD CODE	ÖLÇÜLER DIMENSION (mm)				KESİCİ UÇ INSERT	YEDEK PARÇALAR SPARE PARTS				
	h=H	b	L	f		Levyeye Lever	Levyeye Vidası Lever Screw	Altılık Shim	Altılık Yayı Shim Spring	Anahtar Allen Key
<b>PCLNR/L</b>										
2020 K12	20	20	125	25	CNM.1204..	SPL1 9120	SLV1 M8x19 9224	BAX CN12 9603	SLAY1 9701	AA3
2525 M12	25	25	150	32		SPL2 9121	SLV2 M8x21 9225	BAX CN16 9604	SLAY2 9702	
3232 P12	32	32	170	38		SPL3 9122	SLV3 M10x28 9226	BAX CN19 9605	SLAY3 9703	
2525 M16	25	25	150	32	CNM.1606..					AA4
3232 P16	32	32	170	38						
3232 P19	32	32	170	38	CNM.1906..					AA4
4040 S19	40	40	250	48						



KOD CODE	ÖLÇÜLER DIMENSION (mm)				KESİCİ UÇ INSERT	YEDEK PARÇALAR SPARE PARTS				
	h=H	b	L	f		Levyeye Lever	Levyeye Vidası Lever Screw	Altılık Shim	Altılık Yayı Shim Spring	Anahtar Allen Key
<b>PCMNN</b>										
2020 K12	20	20	125	10	CNM.1204..	SPL1 9120	SLV1 M8x19 9224	BAX CN12 9603	SLAY1 9701	AA3
2525 M12	25	25	150	12.5		SPL2 9121	SLV2 M8x21 9225	BAX CN16 9604	SLAY2 9702	
3232 P12	32	32	170	16		SPL3 9122	SLV3 M10x28 9226	BAX CN19 9605	SLAY3 9703	
2525 M16	25	25	150	12.5	CNM.1606..					AA4
3232 P16	32	32	170	16						
3232 P19	32	32	170	16	CNM.1906..					AA4
4040 S19	40	40	250	20						

## P SİSTEM DIŞ TORNA KATERLERİ P System External Lathe Tool Holders

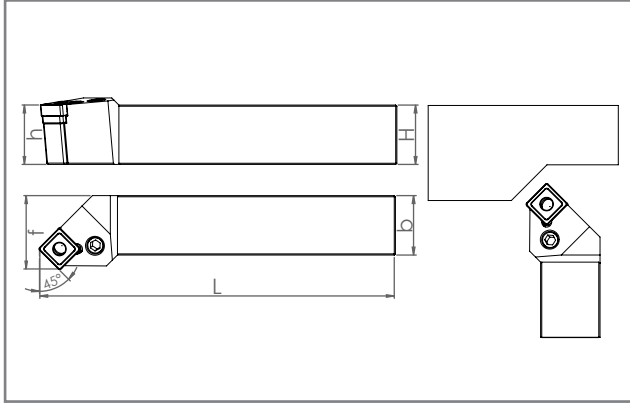

KOD CODE	ÖLÇÜLER DIMENSION (mm)				KESİCİ UÇ INSERT	YEDEK PARÇALAR SPARE PARTS				
	h=H	b	L	f		Levyeye Lever	Levyeye Vidası Lever Screw	Altılık Shim	Altılık Yayı Shim Spring	Anahtar Allen Key
<b>PSSNR/L</b>										
2020 K12	20	20	125	25	SNM.1204..	SPL1 9120	SLV1 M8x19 9224	BAX SN12 9608	SLAY1 9701	AA3
2525 M12	25	25	150	32						
3232 P12	32	32	170	38						
<b>2525 M15</b>	<b>25</b>	<b>25</b>	<b>150</b>	<b>32</b>	SNM.1506..	SPL2 9121	SLV2 M8x21 9225	BAX SN15 9609	SLAY2 9702	
3232 P15	32	32	170	38	SNM.1906	SPL3 9122	SLV3 M10x28 9226	BAX SN19 9629	SLAY3 9703	AA4
3232 P19	32	32	170	38						
4040 S19	40	40	250	48						

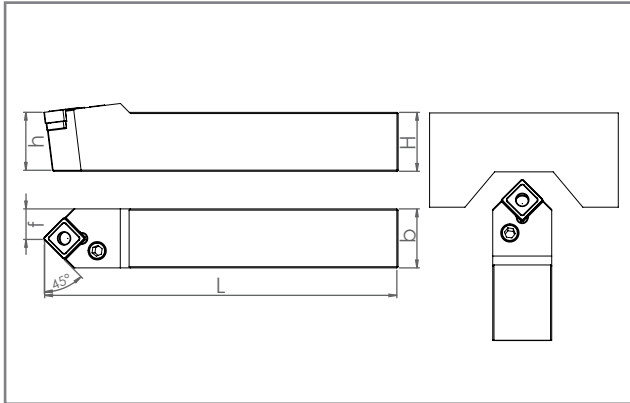





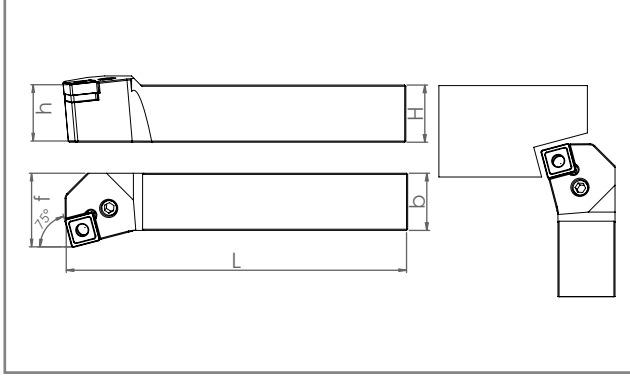

KOD CODE	ÖLÇÜLER DIMENSION (mm)				KESİCİ UÇ INSERT	YEDEK PARÇALAR SPARE PARTS				
	h=H	b	L	f		Levyeye Lever	Levyeye Vidası Lever Screw	Altılık Shim	Altılık Yayı Shim Spring	Anahtar Allen Key
<b>PSDNN</b>										
2020 K12	20	20	125	10	SNM.1204..	SPL1 9120	SLV1 M8x19 9224	BAX SN12 9608	SLAY1 9701	AA3
2525 M12	25	25	150	12.5						
3232 P12	32	32	170	16						
2525 M15	25	25	150	12.5	SNM.1506..	SPL2 9121	SLV2 M8x21 9225	BAX SN15 9609	SLAY2 9702	
3232 P15	32	32	170	16	SNM.1906..	SPL3 9122	SLV3 M10x28 9226	BAX SN19 9629	SLAY3 9703	AA4
3232 P19	32	32	170	16						
4040 S19	40	40	250	20						

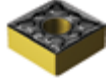





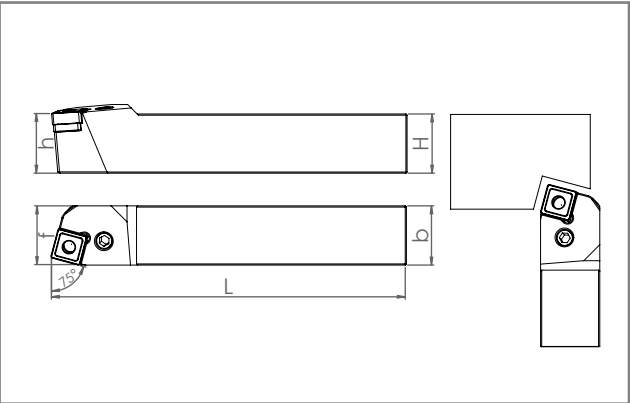

## P SİSTEM DIŞ TORNA KATERLERİ P System External Lathe Tool Holders

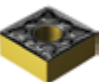

KOD CODE	ÖLÇÜLER DIMENSION (mm)				KESİCİ UÇ INSERT	YEDEK PARÇALAR SPARE PARTS				
	h=H	b	L	f		Levyeye Lever	Levyeye Vidası Lever Screw	Altılık Shim	Altılık Yayı Shim Spring	Anahtar Allen Key
<b>PSKNR/L</b>										
2020 K12	20	20	125	25	SNM.1204..	SPL1 9120	SLV1 M8x19 9224	BAX CN12 9603	SLAY1 9701	AA3
2525 M12	25	25	150	32						
3232 P12	32	32	170	38						
2525 M15	25	25	150	32	SNM.1506..	SPL2 9121	SLV2 M8x21 9225	BAX CN16 9604	SLAY2 9702	AA3
3232 P15	32	32	170	38						
<b>3232 P19</b>	<b>32</b>	<b>32</b>	<b>170</b>	<b>38</b>	SNM.1906..	SPL3 9122	SLV3 M10x28 9226	BAX CN19 9605	SLAY3 9703	AA4
<b>4040 S19</b>	<b>40</b>	<b>40</b>	<b>250</b>	<b>48</b>						



KOD CODE	ÖLÇÜLER DIMENSION (mm)				KESİCİ UÇ INSERT	YEDEK PARÇALAR SPARE PARTS				
	h=H	b	L	f		Levyeye Lever	Levyeye Vidası Lever Screw	Altılık Shim	Altılık Yayı Shim Spring	Anahtar Allen Key
<b>PSBNR/L</b>										
2020 K12	20	20	125	17	SNM.1204..	SPL1 9120	SLV1 M8x19 9224	BAX CN12 9603	SLAY1 9701	AA3
2525 M12	25	25	150	22						
3232 P12	32	32	170	27						
2525 M15	25	25	150	22	SNM.1506..	SPL2 9121	SLV2 M8x21 9225	BAX CN16 9604	SLAY2 9702	AA3
3232 P15	32	32	170	27						
3232 P19	32	32	170	27	SNM.1906..	SPL3 9122	SLV3 M10x28 9226	BAX CN19 9605	SLAY3 9703	AA4
4040 S19	40	40	250	35						

## P SİSTEM DIŞ TORNA KATERLERİ P System External Lathe Tool Holders

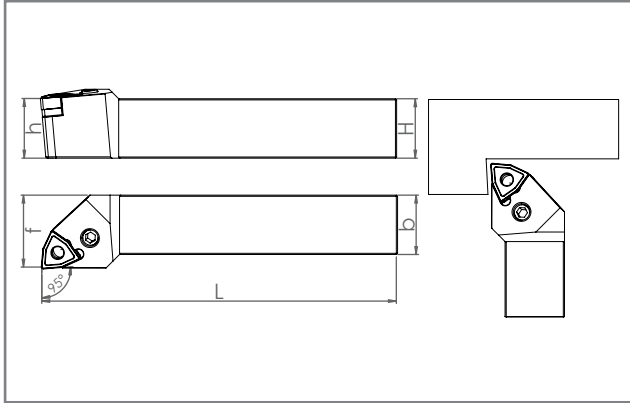

KOD CODE	ÖLÇÜLER DIMENSION (mm)				KESİCİ UÇ INSERT	YEDEK PARÇALAR SPARE PARTS				
	h=H	b	L	f		Levyeye Lever	Levyeye Vidası Lever Screw	Altık Shim	Altık Yayı Shim Spring	Anahtar Allen Key
<b>PWLNRL</b>										
2020 K08	20	20	125	25	WNM.0804..	SPL1 9120	SLV1 M8x19 9224	BAX WN08 9607	SLAY1 9701	AA3
2525 M08	25	25	150	32						
3232 P08	32	32	170	38						
4040 S08	40	40	250	48						

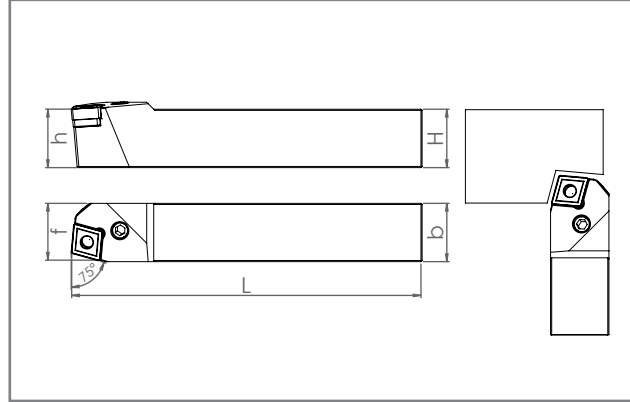

KOD CODE	ÖLÇÜLER DIMENSION (mm)				KESİCİ UÇ INSERT	YEDEK PARÇALAR SPARE PARTS				
	h=H	b	L	f		Levyeye Lever	Levyeye Vidası Lever Screw	Altık Shim	Altık Yayı Shim Spring	Anahtar Allen Key
<b>PCBNRL</b>										
2020 K12	20	20	125	17.5	CNM.1204..	SPL1 9120	SLV1 M8x19 9224	BAX CN12 9603	SLAY1 9701	AA3
2525 M12	25	25	150	22.5						
3232 P12	32	32	170	27.5						
2525 M16	25	25	150	22	CNM.1606..	SPL2 9121	SLV2 M8x21 9225	BAX CN16 9604	SLAY2 9702	AA3
3232 P16	32	32	170	27						
3232 P19	32	32	170	27	CNM.1906..	SPL3 9122	SLV3 M10x28 9226	BAX CN19 9605	SLAY3 9703	AA4
4040 S19	40	40	250	37						

**Teknoloji profesyonellikle birleŖti**  
Technology combined with professionalism

[www.smoXH.com.tr](http://www.smoXH.com.tr)





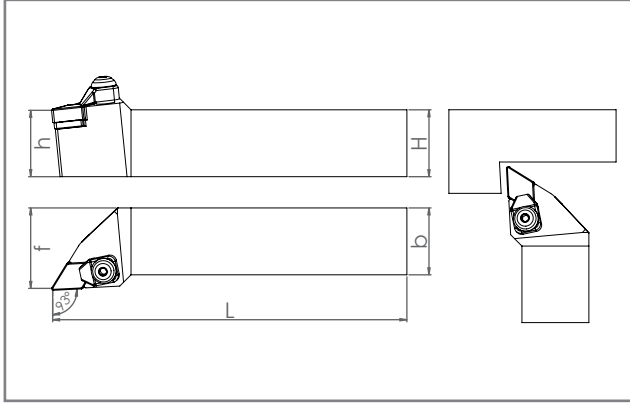

## **C SİSTEM DIŐ TORNALATERLERİ**

C System External Lathe Tool Holders

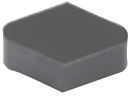





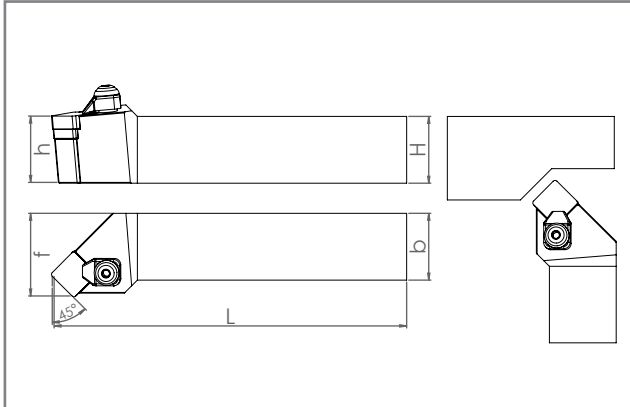

## C SİSTEM DIŞ TORNA KATERLERİ C System External Lathe Tool Holders









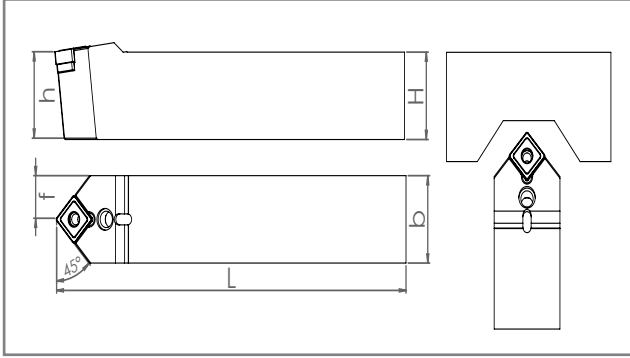

KOD CODE	ÖLÇÜLER DIMENSION (mm)				KESİCİ UÇ INSERT	YEDEK PARÇALAR SPARE PARTS					
	h=H	b	L	f		Baskı Pabucu Wedge Clamp	Baskı Vidası Clamp Screw	Altlık Shim	Altlık Vidası Shim Screw	Sekman Ring	Anahtar Allen Key
<b>CDJNR/L</b>											
2525 M15	25	25	150	32	DN.N 1507..	CSK5 9115	CSBV M8x30x11 9208	BAX DN15 9602	TSAV M4x10 9403	CSS1	AA4
3232 P15	32	32	170	40							









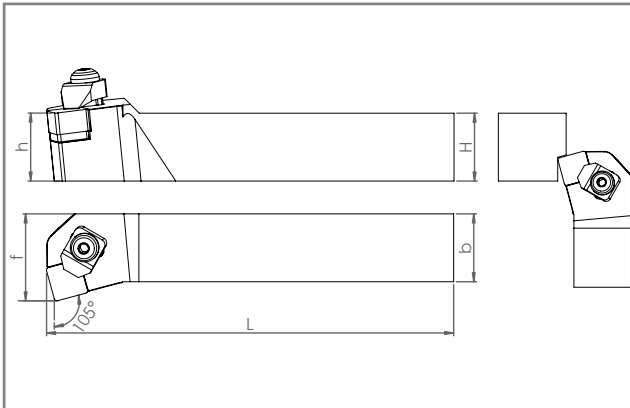

KOD CODE	ÖLÇÜLER DIMENSION (mm)				KESİCİ UÇ INSERT	YEDEK PARÇALAR SPARE PARTS					
	h=H	b	L	f		Baskı Pabucu Wedge Clamp	Baskı Vidası Clamp Screw	Altlık Shim	Altlık Vidası Shim Screw	Sekman Ring	Anahtar Allen Key
<b>CSSNR/L</b>											
2525 M12	25	25	150	32	SN.N 1207..	CSK5 9115	CSBV M8x30x11 9208	BAX SN12 9608	TSAV M4x10 9403	CSS1	AA4
3232 P12	32	32	170	40							

## C SİSTEM DIŞ TORNA KATERLERİ C System External Lathe Tool Holders









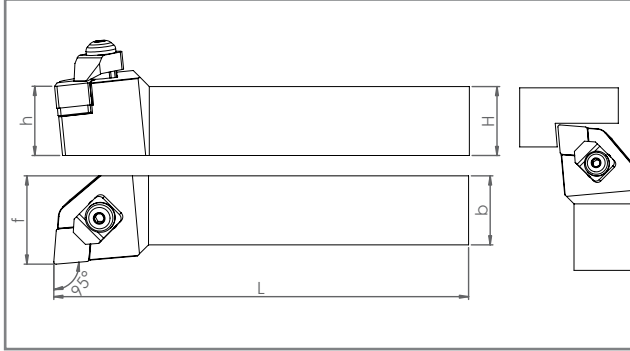

KOD CODE	ÖLÇÜLER DIMENSION (mm)				KESİCİ UÇ INSERT	Baskı Pabucu Wedge Clamp					
	h=H	b	L	f		Baskı Vidası Clamp Screw	Altık Shim	Altık Vidası Shim Screw	Sekman Ring	Anahtar Allen Key	
<b>CSDNN</b>											
2525 M12	25	25	150	32	SN.N 1207..	CSK5 9115	CSBV M8x30x11 9208	BAX SN12 9608	TSAV M4x10 9403	CSS1	AA4
3232 P12	32	32	170	40							









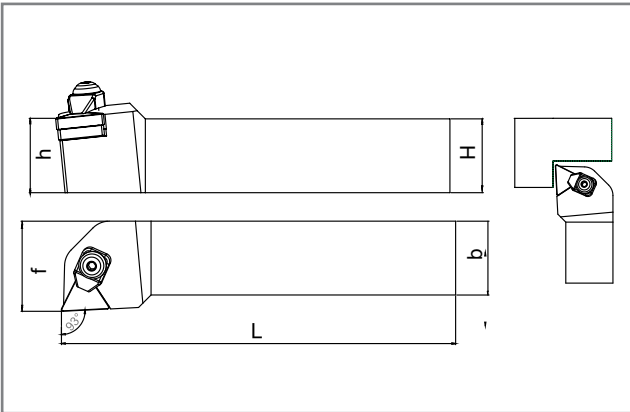

KOD CODE	ÖLÇÜLER DIMENSION (mm)				KESİCİ UÇ INSERT	Baskı Pabucu Wedge Clamp					
	h=H	b	L	f		Baskı Vidası Clamp Screw	Altık Shim	Altık Vidası Shim Screw	Sekman Ring	Anahtar Allen Key	
<b>CSKNR/L</b>											
2525 M12	25	25	150	32	SN.N 1207..	CSK5 9115	CSBV M8x30x11 9208	BAX SN12 9608	TSAV M4x10 9403	CSS1	AA4
3232 P12	32	32	170	40							

## C SİSTEM DIŞ TORNA KATERLERİ C System External Lathe Tool Holders









KOD CODE	ÖLÇÜLER DIMENSION (mm)				KESİCİ UÇ INSERT	YEDEK PARÇALAR SPARE PARTS					
	h=H	b	L	f		Baskı Pabucu Wedge Clamp	Baskı Vidası Clamp Screw	Altık Shim	Altık Vidası Shim Screw	Sekman Ring	Anahtar Allen Key
<b>CCLNR/L</b>											
2525 M12	25	25	150	32	CN.N 1207..	CSK5 9115	CSBV M8x30x11 9208	BAX CN12 9603	TSAV M4x10 9403	CSS1	AA4
3232 P12	32	32	170	40							

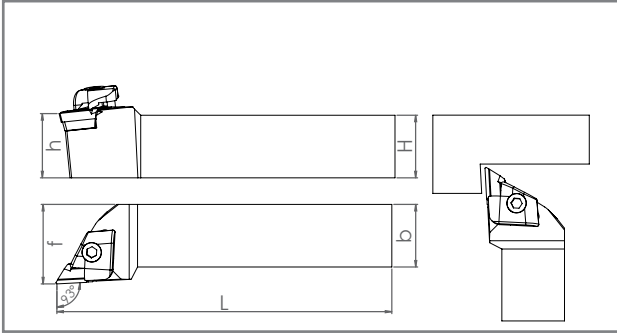

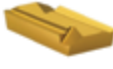
KOD CODE	ÖLÇÜLER DIMENSION (mm)				KESİCİ UÇ INSERT	YEDEK PARÇALAR SPARE PARTS					
	h=H	b	L	f		Baskı Pabucu Wedge Clamp	Baskı Vidası Clamp Screw	Altık Shim	Altık Vidası Shim Screw	Sekman Ring	Anahtar Allen Key
<b>CTJNR/L</b>											
2525 M16	25	25	150	32	TN.N 1607..	CSK4 9114	CSBV M8x30x11 9208	BAX TN16 9610	TSAV M4x10x6 9402	CSS1	AA4
3232 P16	32	32	170	40							

## C SİSTEM DIŞ TORNA KATERLERİ C System External Lathe Tool Holders



KOD CODE	ÖLÇÜLER DIMENSION (mm)				KESİCİ UÇ INSERT	YEDEK PARÇALAR SPARE PARTS				
	h=H	b	L	f		Baskı Parçası Clamp	Baskı Vidası Screw	Altık Shim	Altık Vidası Shim Screw	Anahtar Allen Key
<b>CKJNR/L</b>										
2020 K16	20	20	125	25	KNUX 1604..	CSK6/R-9117 CSK7/L-9118	CSBV1 M6x30 9223	BAX KN16/R-9621 KN16/L-9622	CSAV M3x10 9401	AA5
2525 M16	25	25	150	32						
3232 P16	32	32	170	38						
4040 S16	40	40	250	48						

**Teknoloji profesyonellikle birleŖti**  
Technology combined with professionalism

[www.smaxh.com.tr](http://www.smaxh.com.tr)

## **M SİSTEM DIŐ TORNA KATERLERİ**







M System External Lathe Tool Holders

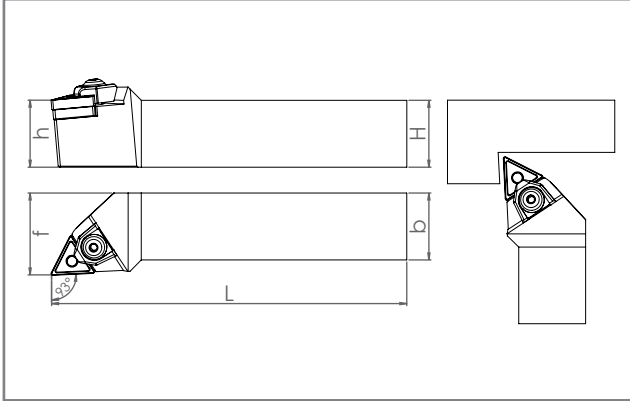









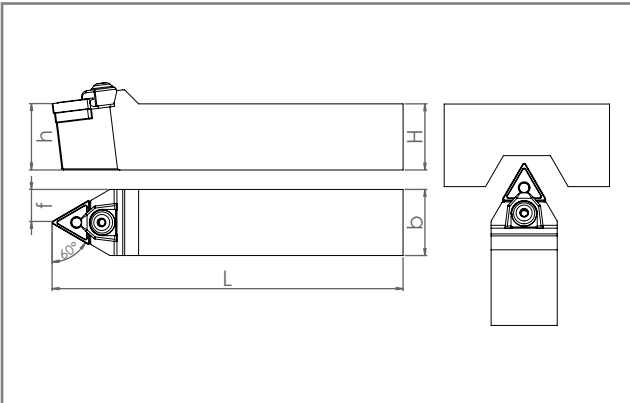

## M SİSTEM DIŞ TORNA KATERLERİ M System External Lathe Tool Holders



KOD CODE	ÖLÇÜLER DIMENSION (mm)				KESİCİ UÇ INSERT	YEDEK PARÇALAR SPARE PARTS					
	h=H	b	L	f		Baskı Parçası Clamp	Baskı Vidası Screw	Altılık Shim	Pim Pin	Pul Stamp	Anahtar Allen Key
<b>MTJNR/L</b>											
2020 K16	20	20	125	25	TNM.1604..	MSK1 9107	TSBV M6x25 9203	BAX TN16 9610	BMP1 3.70x5x16 9309	TSP 6.5X12 9705	AA3
2525 M16	25	25	150	32			TSBV M6x30 9205	BAX TN22 9611	BMP2 5x6x16 9310		
3232 P16	32	32	170	38							
2525 M22	25	25	150	32	TNM.2204..	MSK1 9107	TSBV M6x30 9205	BAX TN22 9611	BMP2 5x6x16 9310	TSP 6.5X12 9705	AA3
3232 P22	32	32	170	38							
4040 S22	40	40	250	48							



KOD CODE	ÖLÇÜLER DIMENSION (mm)				KESİCİ UÇ INSERT	YEDEK PARÇALAR SPARE PARTS					
	h=H	b	L	f		Baskı Parçası Clamp	Baskı Vidası Screw	Altılık Shim	Pim Pin	Pul Stamp	Anahtar Allen Key
<b>MTENN</b>											
2020 K16	20	20	125	10	TNM.1604..	MSK1 9107	TSBV M6x25 9203	BAX TN16 9610	BMP1 3.70x5x16 9309	TSP 6.5X12 9705	AA3
2525 M16	25	25	150	12.5			TSBV M6x30 9205	BAX TN22 9611	BMP2 5x6x16 9310		
3232 P16	32	32	170	16							
2525 M22	25	25	150	12.5	TNM.2204..	MSK1 9107	TSBV M6x30 9205	BAX TN22 9611	BMP2 5x6x16 9310	TSP 6.5X12 9705	AA3
3232 P22	32	32	170	16							
4040 S22	40	40	250	20							

## M SİSTEM DIŞ TORNA KATERLERİ

### M System External Lathe Tool Holders

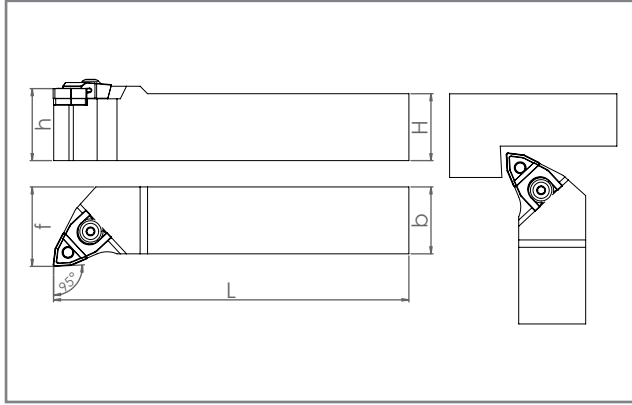

KOD CODE	ÖLÇÜLER DIMENSION (mm)				KESİCİ UÇ INSERT	YEDEK PARÇALAR SPARE PARTS					
	h=H	b	L	f		Baskı Parçası Clamp	Baskı Vidası Screw	Altık Shim	Pim Pin	Yay Spring	Anahtar Allen Key
<b>MWLNR/L</b>											
1616 H06	16	16	100	20	WNM.0604..	MSK4 9110	TSBV M5x18 9201 TSBV M5x24 9202	BAX WN06 9606	BMP4 3.70x5x13 9312	-	AA3
2020 K06	20	20	125	25							
2525 M06	25	25	150	32							
2020 K08	20	20	125	25	WNM.0804..	MSK3 9109	TSBV M6x30 9205	BAX WN08 9607	BMP3 5x6 9311	TSP 6.5X12 9705	AA3
2525 M08	25	25	150	32							
3232 P08	32	32	170	38							
4040 S08	40	40	170	48							

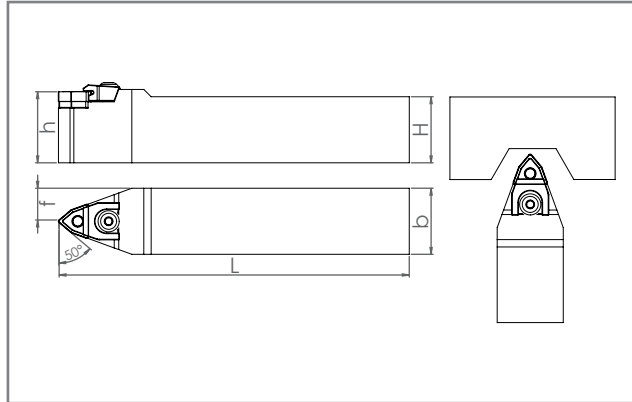

KOD CODE	ÖLÇÜLER DIMENSION (mm)				KESİCİ UÇ INSERT	YEDEK PARÇALAR SPARE PARTS					
	h=H	b	L	f		Baskı Parçası Clamp	Baskı Vidası Screw	Altık Shim	Pim Pin	Yay Spring	Anahtar Allen Key
<b>MWDNN</b>											
1616 H06	16	16	100	8	WNM.0604..	MSK4 9110	TSBV M5x18 9201 TSBV M5x24 9202	BAX WN06 9606	BMP4 3.70x5x13 9312	-	AA3
2020 K06	20	20	125	10							
2525 M06	25	25	150	12.5							
2020 K08	20	20	125	10	WNM.0804..	MSK3 9109	TSBV M6x30 9205	BAX WN08 9607	BPM3 5x6 9311	TSP 6.5X12 9705	AA3
2525 M08	25	25	150	12.5							
3232 P08	32	32	170	16							
4040 S08	40	40	170	20							

**Teknoloji profesyonellikle birleŖti**  
Technology combined with professionalism





[www.smoxh.com.tr](http://www.smoxh.com.tr)

## **S SİSTEM DIŐ TORNA KATERLERİ** S System External Lathe Tool Holders

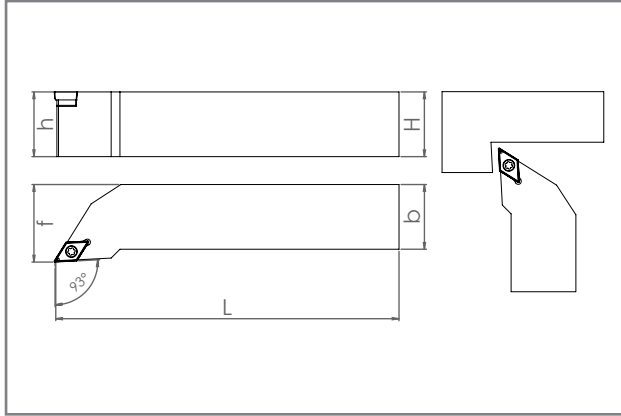



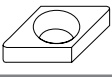

## S SİSTEM DIŞ TORNA KATERLERİ S System External Lathe Tool Holders

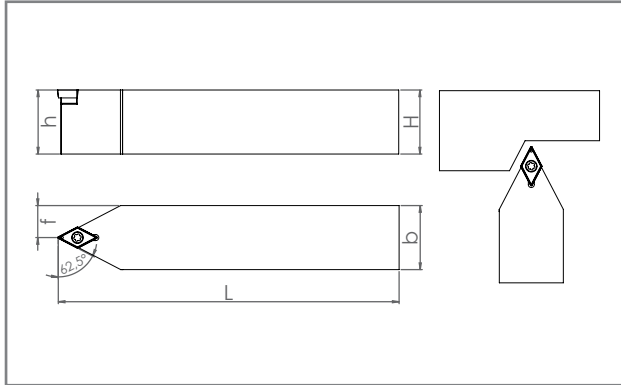



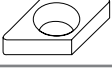

KOD CODE	ÖLÇÜLER DIMENSION (mm)				KESİCİ UÇ INSERT	YEDEK PARÇALAR SPARE PARTS			
	h	b	L	f		Sıkma Vidası Clamp Screw	Altık Shim	Altık Vidası Shim Screw	Anahtar Torx Key
<b>SDJCR/L</b>									
0808 E07	08	08	70	10	DCM. 0702..	SSV M2.5x6 9505	-	-	T08
1010 E07	10	10	70	12					
1212 F07	12	12	80	16					
1616 H07	16	16	100	20					
1212 F11	12	12	80	16	DCM. 11T3..	SSV M3.5x10-9511	BAX DC11 9613	SBV M5.05 A3.5x11 9407	T15
1616 H11	16	16	100	20					
2020 K11	20	20	125	25					
2525 M11	25	25	150	30					
3232 P11	32	32	170	38					



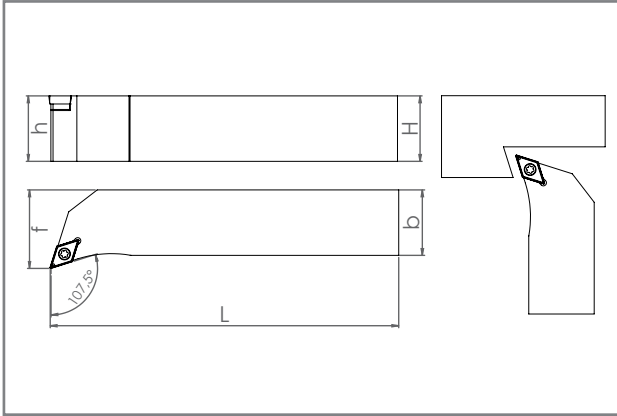

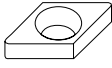

KOD CODE	ÖLÇÜLER DIMENSION (mm)				KESİCİ UÇ INSERT	YEDEK PARÇALAR SPARE PARTS			
	h=H	b	L	f		Sıkma Vidası Clamp Screw	Altık Shim	Altık Vidası Shim Screw	Anahtar Torx Key
<b>SDNCN</b>									
0808 E07	08	08	70	04	DCM. 0702..	SSV M2.5x6 9505	-	-	T08
1010 E07	10	10	70	05					
1212 F07	12	12	80	06					
1616 H07	16	16	100	08					
1212 F11	12	12	80	06	DCM. 11T3..	SSV M3.5x10-9511	BAX DC11 9613	SBV M5.05 A3.5x11 9407	T15
1616 H11	16	16	100	08					
2020 K11	20	20	125	10					
2525 M11	25	25	150	12.5					
3232 P11	32	32	170	16					

## S SİSTEM DIŞ TORNA KATERLERİ S System External Lathe Tool Holders

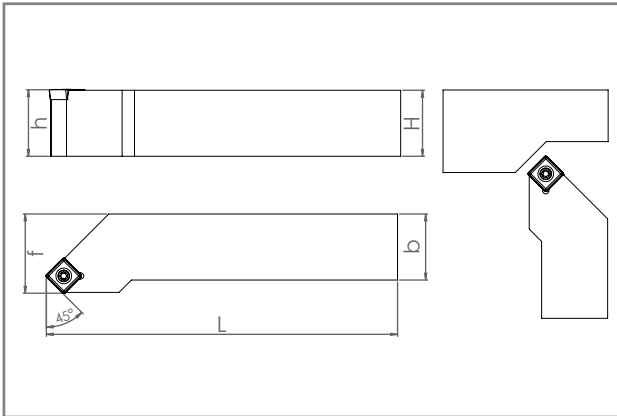



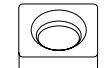



KOD CODE	ÖLÇÜLER DIMENSION (mm)				KESİCİ UÇ INSERT	YEDEK PARÇALAR SPARE PARTS			
	h=H	b	L	f		Sıkma Vidası Clamp Screw	Altık Shim	Altık Vidası Shim Screw	Anahtar Torx Key
<b>SDHCR/L</b>									
0808 E07	08	08	70	10	DCM. 0702..	SSV M2.5x6 9505	-	-	T08
1010 E07	10	10	70	12					
1212 F07	12	12	80	16					
1616 H07	16	16	100	20					
1616 H11	16	16	100	20	DCM. 11T3..	SSV M3.5x14 9512	BAX DC11 9613	SBV M5.05 A3.5x11 9407	T15
2020 K11	20	20	125	25					
2525 M11	25	25	150	30					
3232 P11	32	32	170	38					

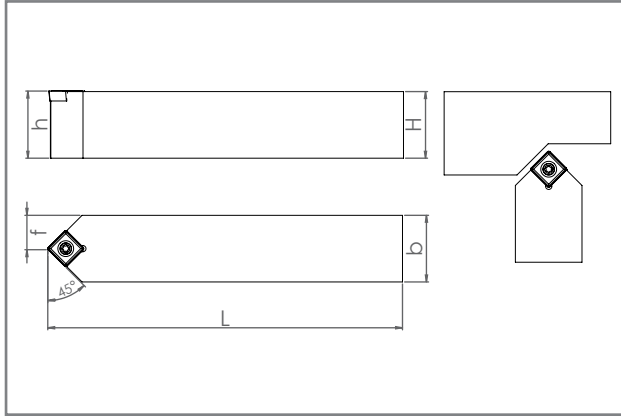





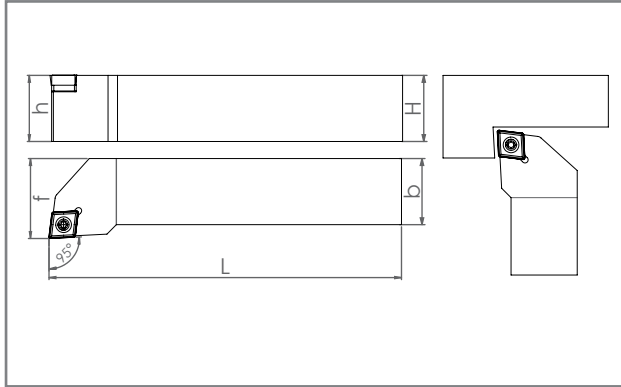

KOD CODE	ÖLÇÜLER DIMENSION (mm)				KESİCİ UÇ INSERT	YEDEK PARÇALAR SPARE PARTS			
	h=H	b	L	f		Sıkma Vidası Clamp Screw	Altık Shim	Altık Vidası Shim Screw	Anahtar Torx Key
<b>SSSCR/L</b>									
1212 F09	12	12	80	16	SCM. 09T3..	SSV M3.5x10 9511	-	-	T15
1616 H09	16	16	100	20					
2020 K09	20	20	125	25					
2525 M09	25	25	150	30					
1616 H12	16	16	100	20	SCM. 1204..	SSV M4x12 9515	BAX SC12 9615	SBV4 M6.075 A4x13 9412	T15
2020 K12	20	20	125	25					
2525 M12	25	25	150	30					

## S SİSTEM DIŞ TORNA KATERLERİ S System External Lathe Tool Holders

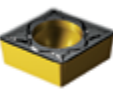

KOD CODE	ÖLÇÜLER DIMENSION (mm)				KESİCİ UÇ INSERT	YEDEK PARÇALAR SPARE PARTS			
	h=H	b	L	f		Sıkma Vidası Clamp Screw	Altık Shim	Altık Vidası Shim Screw	Anahtar Torx Key
<b>SSDCN</b>									
1212 F09	12	12	80	6	SCM.09T3..	SSV M3.5x10 <b>9511</b>	-	-	T15
1616 H09	16	16	100	8					
2020 K09	20	20	125	10					
2525 M09	25	25	150	12.5					
1616 H12	16	16	100	8	SCM.1204..	SSV M4x12 <b>9515</b>	BAX SC12 <b>9615</b>	SBV4 M6.075 A4x13 <b>9412</b>	T15
2020 K12	20	20	125	10					
2525 M12	25	25	150	12.5					







KOD CODE	ÖLÇÜLER DIMENSION (mm)				KESİCİ UÇ INSERT	YEDEK PARÇALAR SPARE PARTS			
	h=H	b	L	f		Sıkma Vidası Clamp Screw	Altık Shim	Altık Vidası Shim Screw	Anahtar Torx Key
<b>SCLCR/L</b>									
0808 E06	8	8	70	10	CCM.0602..	SSV M2.5x6 <b>9505</b>	-	-	T08
1010 E06	10	10	70	12					
1212 F06	12	12	80	16					
1212 F09	12	12	80	16	CCM.09T3..	SSV M3.5x10 <b>9511</b>	-	-	T15
1616 H09	16	16	100	20					
2020 K09	20	20	125	25					
2525 M09	25	25	150	30					
<b>1616 H12</b> 	16	16	100	20	CCM.1204..	SSV M4x12 <b>9515</b>	-	-	T15
2020 K12	20	20	125	25					
2525 M12	25	25	150	30					
						BAX CC12 <b>9617</b>		SBV1 M6.075 A4x13 <b>9410</b>	

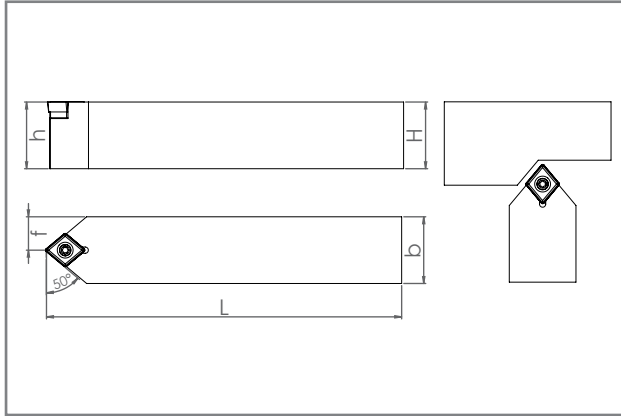

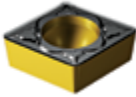

## S SİSTEM DIŞ TORNA KATERLERİ

### S System External Lathe Tool Holders

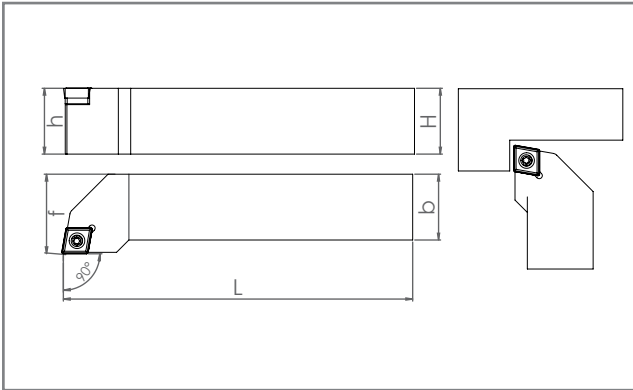

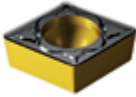
KOD CODE	ÖLÇÜLER DIMENSION (mm)				KESİCİ UÇ INSERT	YEDEK PARÇALAR SPARE PARTS			
	h=H	b	L	f		Sıkma Vidası Clamp Screw	Altık Shim	Altık Vidası Shim Screw	Anahtar Torx Key
<b>SCMCN</b>									
0808 E06	08	08	70	04	CCM. 0602..	SSV M2.5x6 9505	-	-	T08
1010 E06	10	10	70	05		SSV M3.5x10 9511	-	-	
1212 F09	12	12	80	06	CCM. 09T3..	SSV M3.5x14 9512	BAX CC09 9616	SBV M5.05 A3.5x11 9407	T15
1616 H09	16	16	100	08		SSV M4x12 9515	BAX CC12 9617	SBV1 M6.075 A4x13 9410	
2020 K09	20	20	125	10					
2525 M09	25	25	150	12.5					
2020 K12	20	20	125	10					
2525 M12	25	25	150	12.5					



KOD CODE	ÖLÇÜLER DIMENSION (mm)				KESİCİ UÇ INSERT	YEDEK PARÇALAR SPARE PARTS			
	h=H	b	L	f		Sıkma Vidası	Altık Shim	Altık Vidası Shim Screw	Anahtar Allen Key
<b>SCACR/L</b>									
0808 E06	08	08	70	10	CCM. 0602..	SSV M2.5x6 9505	-	-	T08
1010 E06	10	10	70	12		SSV M3.5x10 9511	-	-	
1212 F09	12	12	80	16	CCM. 09T3..	SSV M3.5x14 9512	BAX CC09 9616	SBV M5.05 A3.5x11 9407	T15
1616 H09	16	16	100	20		SSV M4x12 9515	BAX CC12 9617	SBV1 M6.075 A4x13 9410	
2020 K09	20	20	125	25					
2525 M09	25	25	150	30					
2020 K12	20	20	125	25					
2525 M12	25	25	150	30					

## S SİSTEM DIŞ TORNA KATERLERİ S System External Lathe Tool Holders

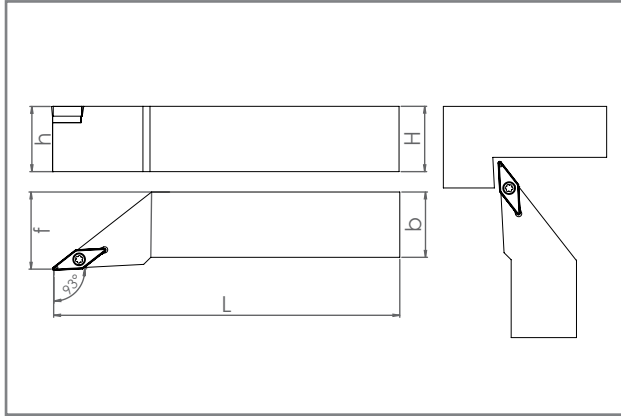

KOD CODE	ÖLÇÜLER DIMENSION (mm)				KESİCİ UÇ INSERT	YEDEK PARÇALAR SPARE PARTS			
	h=H	b	L	f		Sıkma Vidası Clamp Screw	Altık Shim	Altık Vidası Shim Screw	Anahtar Torx Key
<b>SVJBR/L</b>									
1212 F11	12	12	80	16	VBM. 1103..	SSV M2.5x6 9505	-	-	T08
1616 H11	16	16	100	20					
2020 K11	20	20	125	25					
2525 M11	25	25	150	30					
1616 H16	16	16	100	20	VBM. 1604..	SSV M3.5x14 9512	BAX VB16 9618	SBV M5.05 A3.5x11 9407	T15
2020 K16	20	20	125	25					
2525 M16	25	25	150	30					
3232 P16	32	32	170	38					

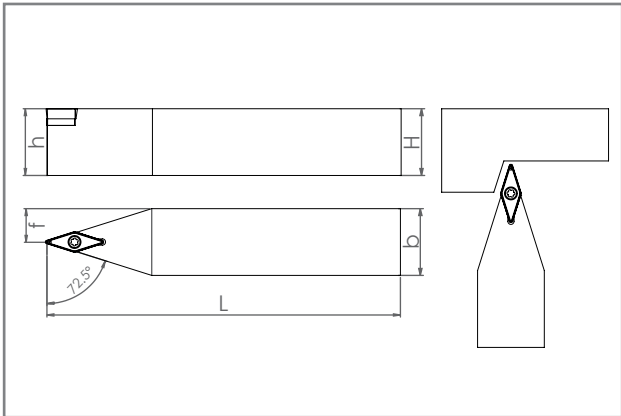





KOD CODE	ÖLÇÜLER DIMENSION (mm)				KESİCİ UÇ INSERT	YEDEK PARÇALAR SPARE PARTS			
	h=H	b	L	f		Sıkma Vidası Clamp Screw	Altık Shim	Altık Vidası Shim Screw	Anahtar Torx Key
<b>SVVBN</b>									
1616 H11	16	16	100	08	VBM. 1103..	SSV M2.5x6 9505	-	-	T08
2020 K11	20	20	125	10					
2525 M11	25	25	150	12.5					
1616 H16	16	16	100	08	VBM. 1604..	SSV M3.5x14 9512	BAX VB16 9618	SBV M5.05 A3.5x11 9407	T15
2020 K16	20	20	125	10					
2525 M16	25	25	150	12.5					
3232 P16	32	32	170	16					

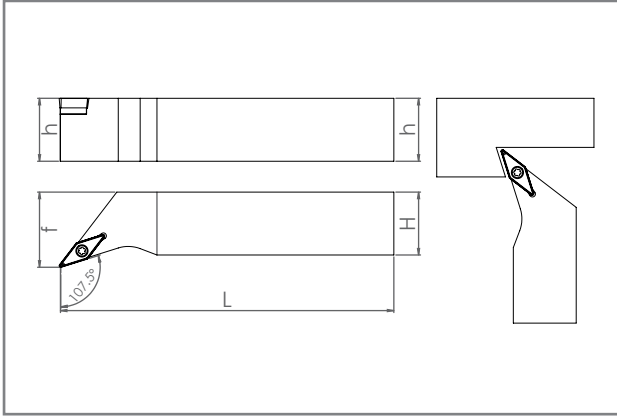



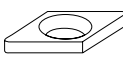

## S SİSTEM DIŞ TORNA KATERLERİ S System External Lathe Tool Holders

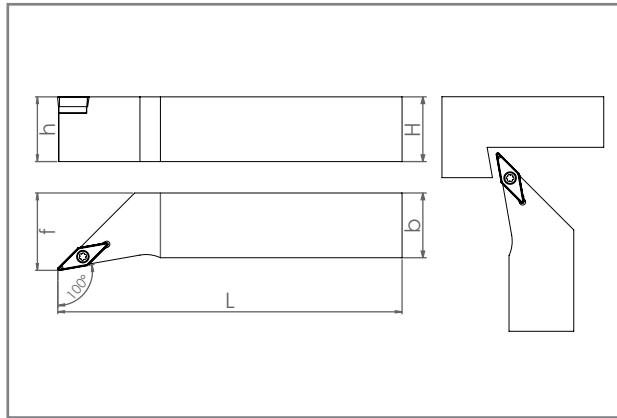



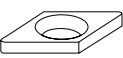



KOD CODE	ÖLÇÜLER DIMENSION (mm)				KESİCİ UÇ INSERT	YEDEK PARÇALAR SPARE PARTS			
	h=H	b	L	f		Sıkma Vidası Clamp Screw	Altık Shim	Altık Vidası Shim Screw	Anahtar Torx Key
<b>SVHBR/L</b>									
1616 H11	16	16	100	20	VBM. 1103..	SSV M2.5x6 9505	-	-	T08
2020 K11	20	20	125	25					
2525 M11	25	25	150	30					
1616 H16	16	16	100	20	VBM. 1604..	SSV M3.5x14 9512	BAX VB16 9618	SBV M5.05 A3.5x11 9407	T15
2020 K16	20	20	125	25					
2525 M16	25	25	150	30					
3232 P16	32	32	170	38					

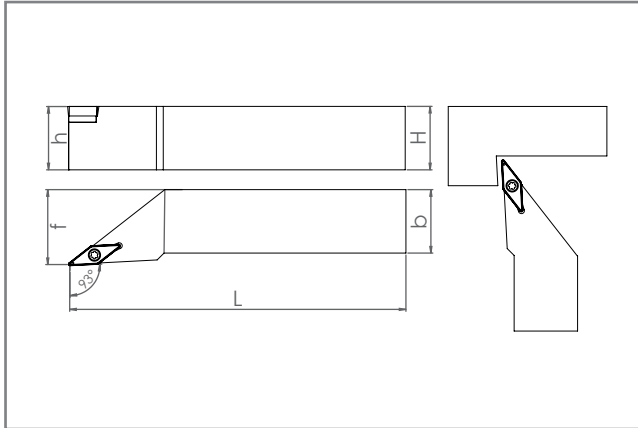





KOD CODE	ÖLÇÜLER DIMENSION (mm)				KESİCİ UÇ INSERT	YEDEK PARÇALAR SPARE PARTS			
	h=H	b	L	f		Sıkma Vidası Clamp Screw	Altık Shim	Altık Vidası Shim Screw	Anahtar Torx Key
<b>SVZBR/L</b>									
1616 H11	16	16	100	20	VBM. 1103..	SSV M2.5x6 9505	-	-	T08
2020 K11	20	20	125	25					
2525 M11	25	25	150	30					
1616 H16	16	16	100	20	VBM. 1604..	SSV M3.5x14 9512	BAX VB16 9618	SBV M5.05 A3.5x11 9407	T15
2020 K16	20	20	125	25					
2525 M16	25	25	150	30					
3232 P16	32	32	170	38					

## S SİSTEM DIŞ TORNA KATERLERİ S System External Lathe Tool Holders

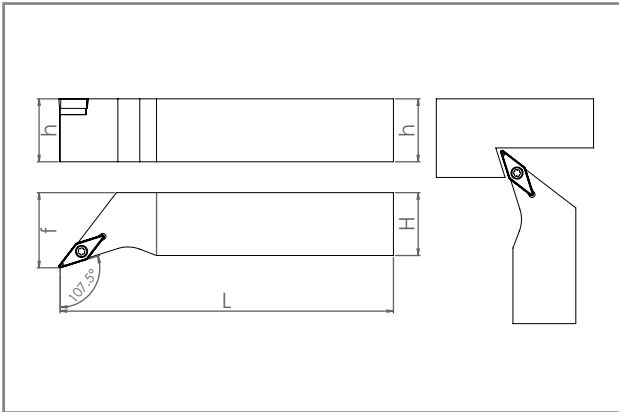

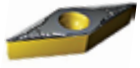
KOD CODE	ÖLÇÜLER DIMENSION (mm)				KESİCİ UÇ INSERT	YEDEK PARÇALAR SPARE PARTS			
	h=H	b	L	f		Sıkma Vidası Clamp Screw	Altık Shim	Altık Vidası Shim Screw	Anahtar Torx Key
<b>SVJCR/L</b>									
1616 H11	16	16	100	20	VC.T 1103..	SSV M2.5x6 9505	-	-	T08
2020 K11	20	20	125	25					
2020 K16	20	20	125	25	VC.T 1604..	SSV M3.5x14 9512	BAX VC16 9620	SBV M5.05 A3.5x11 9407	T15
2525 M16	25	25	150	30					
3232 P16	32	32	170	38					







KOD CODE	ÖLÇÜLER DIMENSION (mm)				KESİCİ UÇ INSERT	YEDEK PARÇALAR SPARE PARTS			
	h=H	b	L	f		Sıkma Vidası Clamp Screw	Altık Shim	Altık Vidası Shim Screw	Anahtar Torx Key
<b>SVHCR/L</b>									
1616 H11	16	16	100	20	VC.T 1103..	SSV M2.5x6 9505	-	-	T08
2020 K11	20	20	125	25					
2020 K16	20	20	125	25	VC.T 1604..	SSV M3.5x14 9512	BAX VC16 9620	SBV M5.05 A3.5x11 9407	T15
2525 M16	25	25	150	30					
3232 P16	32	32	170	38					

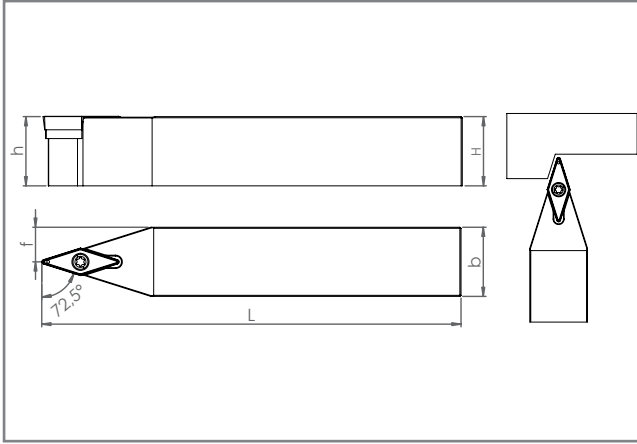

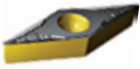

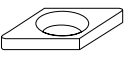
## S SİSTEM DIŞ TORNA KATERLERİ

### S System External Lathe Tool Holders

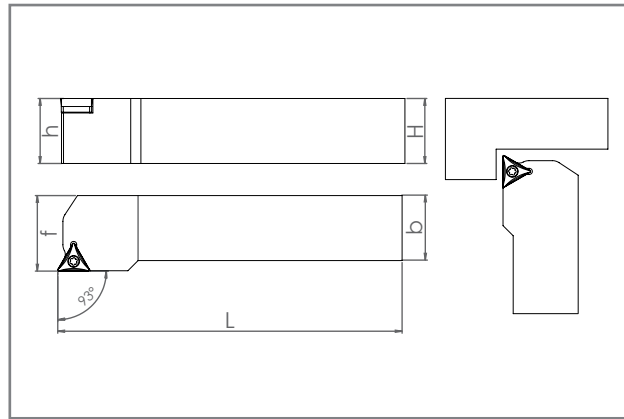

KOD CODE	ÖLÇÜLER DIMENSION (mm)				KESİCİ UÇ INSERT	YEDEK PARÇALAR SPARE PARTS			
	h=H	b	L	f		Sıkma Vidası Clamp Screw	Altık Shim	Altık Vidası Shim Screw	Anahtar Torx Key
<b>SVVCN</b>									
1616 H11	16	16	100	8	VC.T 1103..	SSV M2.5x6 9505	-	-	T08
2020 K11	20	20	125	10					
2020 K16	20	20	125	10	VC.T 1604..	SSV M3.5x14 9512	BAX VC16 9620	SBV M5.05 A3.5x11 9407	T15
2525 M16	25	25	150	12.5					
3232 P16	32	32	170	16					



KOD CODE	ÖLÇÜLER DIMENSION (mm)				KESİCİ UÇ INSERT	YEDEK PARÇALAR SPARE PARTS			
	h=H	b	L	f		Sıkma Vidası Clamp Screw	Altık Shim	Altık Vidası Shim Screw	Anahtar Torx Key
<b>STJCR/L</b>									
0808 E09	08	08	70	10	TCM.0902..	SSV M2.2x5 9503	-	-	T07
1010 E09	10	10	70	12					
1212 F11	12	12	80	16	TCM.1102..	SSV M2.5x6 9505	-	-	T08
1616 H11	16	16	100	20					
1616 H16	16	16	100	20					
2020 K16	20	20	125	25	TCM.16T3..	SSV M3.5x14 9512	BAX TC16 9619	SBV M5.05 A3.5x11 9407	T15
2525 M16	25	25	150	30					
2525 M16	25	25	150	30					
3232 P16	32	32	170	38					

## S SİSTEM DIŞ TORNA KATERLERİ S System External Lathe Tool Holders

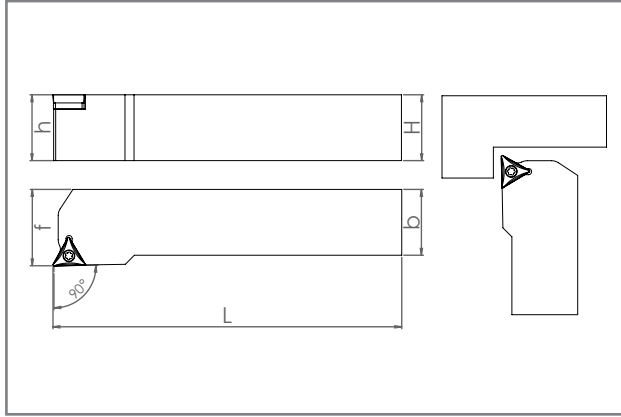

KOD CODE	ÖLÇÜLER DIMENSION (mm)				KESİCİ UÇ INSERT	YEDEK PARÇALAR SPARE PARTS			
	h=H	b	L	f		Sıkma Vidası Clamp Screw	Altık Shim	Altık Vidası Shim Screw	Anahtar Torx Key
<b>STGCR/L</b>									
0808 E09	08	08	70	10	TCM.0902..	SSV M2.2x5 9503	-	-	T07
1010 E09	10	10	70	12					T08
1212 F11	12	12	80	16	TCM.1102..	SSV M2.5x6 9505	-	-	T08
1616 H11	16	16	100	20					
1616 H16	16	16	100	20	TCM.16T3..	SSV M3.5x14 9512	BAX TC16 9619	SBV M5.05 A3.5x11 9407	T15
2020 K16	20	20	125	25					
2525 M16	25	25	150	30					
3232 P16	32	32	170	38					

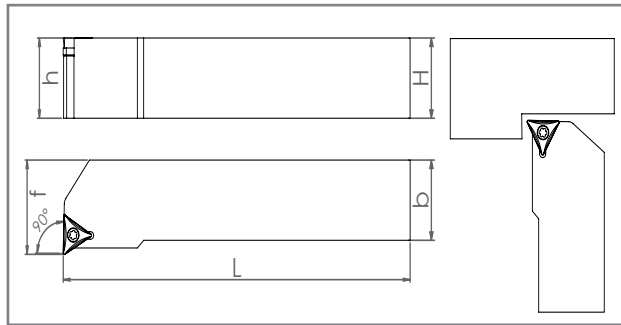





KOD CODE	ÖLÇÜLER DIMENSION (mm)				KESİCİ UÇ INSERT	YEDEK PARÇALAR SPARE PARTS			
	h=H	b	L	f		Sıkma Vidası Clamp Screw	Altık Shim	Altık Vidası Shim Screw	Anahtar Torx Key
<b>STFCR/L</b>									
0808 E09	08	08	70	10	TCM.0902..	SSV M2.2x5 9503	-	-	T07
1010 E09	10	10	70	12					T08
1212 F11	12	12	80	16	TCM.1102..	SSV M2.5x6 9505	-	-	T08
1616 H11	16	16	100	20					
1616 H16	16	16	100	20	TCM.16T3..	SSV M3.5x14 9512	BAX TC16 9619	SBV M5.05 A3.5x11 9407	T15
2020 K16	20	20	125	25					
2525 M16	25	25	150	30					
3232 P16	32	32	170	38					

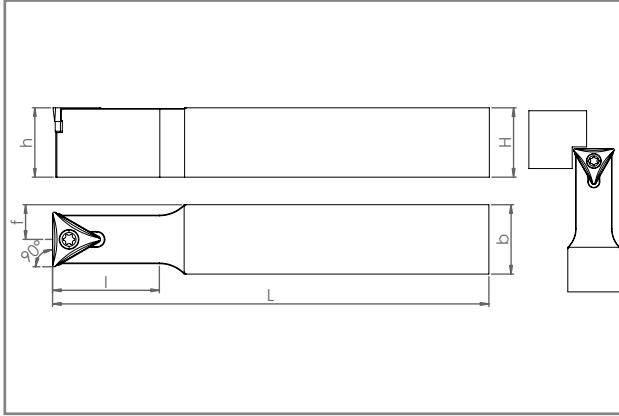

## S SİSTEM DIŞ TORNA KATERLERİ

### S System External Lathe Tool Holders

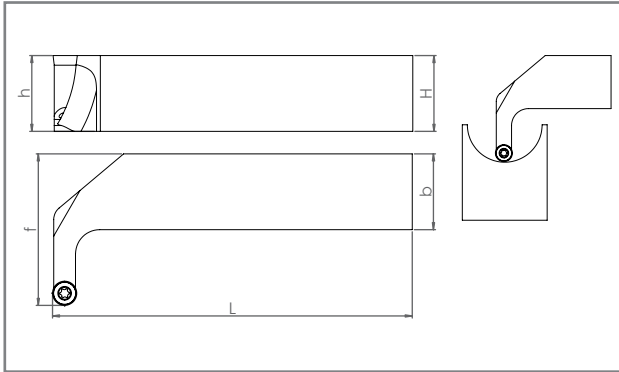

KOD CODE	ÖLÇÜLER DIMENSION (mm)					KESİCİ UÇ INSERT	YEDEK PARÇALAR SPARE PARTS			
	h=H	b	L	f	l		Sıkma Vidası Clamp Screw	Altık Shim	Altık Vidası Shim Screw	Anahtar Torx Key
<b>STNCN</b>										
2020 K11	20	20	125	10	30	TCM.1102..	SSV M2.5x6 9505	-	-	T08
2020 K16	20	20	125	10	30	TCM.16T3..	SSV M3.5x14 9512	BAX TC16 9619	SBV M5.05 A3.5x11 9407	T15
2525 M16	25	25	150	12.5	36					
3232 P16	32	32	170	16	43					

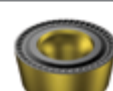



KOD CODE	ÖLÇÜLER DIMENSION (mm)				KESİCİ UÇ INSERT	YEDEK PARÇALAR SPARE PARTS			
	h=H	b	L	f		Sıkma Vidası Clamp Screw	Altık Shim	Altık Vidası Shim Screw	Anahtar Torx Key
<b>SRXCR/L</b>							-	-	
2525 M08	25	25	120	50	RC.T 0803..	SSV-M3x8 9508	-	-	T08
2525 M10	25	25	120	50	RC.T 1003..	SSV M3.5x10 9511			T15
2525 K12	25	25	120	50	RC.T 1204..				

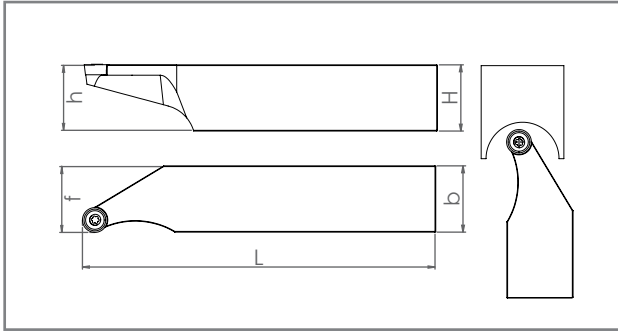

## S SİSTEM DIŞ TORNA KATERLERİ

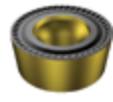
### S System External Lathe Tool Holders

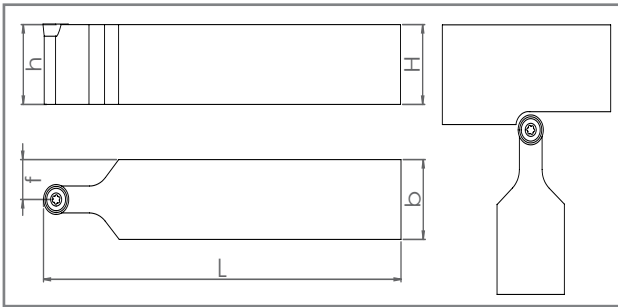

KOD CODE	ÖLÇÜLER DIMENSION (mm)				KESİCİ UÇ INSERT	YEDEK PARÇALAR SPARE PARTS			
	h=H	b	L	f		Sıkma Vidası Clamp Screw	Altık Shim	Altık Vidası Shim Screw	Anahtar Torx Key
<b>SRHCR/L</b>							-	-	
2020 K10	20	20	120	20	RC.1003..	SSV M3.5x10 9511	-	-	T15
2525 K10	25	25	120	25					
2020 K12	20	20	120	20	RC.1204..	SSV M5x13 9519	-	-	T20
2525 K12	25	25	120	25					
2020 K16	20	20	120	20	RC.1605..	SSV M5x13 9519	-	-	T20
2525 K16	25	25	120	25					

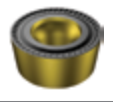



KOD CODE	ÖLÇÜLER DIMENSION (mm)				KESİCİ UÇ INSERT	YEDEK PARÇALAR SPARE PARTS			
	h=H	b	L	f		Sıkma Vidası Clamp Screw	Altık Shim	Altık Vidası Shim Screw	Anahtar Torx Key
<b>SRDCN</b>							-	-	
1616 H06	16	16	100	8	RC.T 0602..	SSV M2.5x6 9505	-	-	T08
2020 K06	20	20	125	10					
2525 M06	25	25	150	12.5					
1616 H08	16	16	100	08	RC.T 0803..	SSV M3x8 9508	-	-	T15
2020 K08	20	20	125	10					
2525 M08	25	25	150	12.5					
3232 P08	32	32	170	16	RC.T 1003..	SSV M3.5x10 9511	-	-	T20
1616 H10	16	16	100	08					
2020 K10	20	20	125	10					
2525 M10	25	25	150	12.5	RC.T 1204..	SSV M5x13 9519	-	-	T20
3232 P10	32	32	170	16					
2020 K12	20	20	125	10					
2525 M12	25	25	150	12.5	RC.T 1605..	SSV M6x16 9520	-	-	T20
3232 P12	32	32	170	16					
2525 M16	25	25	150	12.5					
3232 P16	32	32	170	16	RC.T 2006..	SSV M6x16 9520	-	-	T20
2525 M20	25	25	150	12.5					
3232 P20	32	32	170	16					
4040 S20	40	40	250	20					

## S SİSTEM DIŞ TORNA KATERLERİ

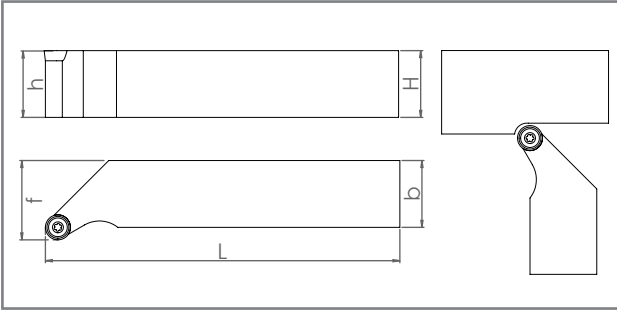
### S System External Lathe Tool Holders

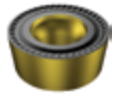

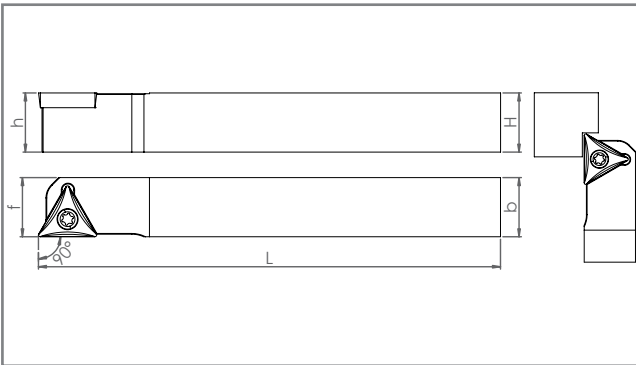

KOD CODE	ÖLÇÜLER DIMENSION (mm)				KESİCİ UÇ INSERT	YEDEK PARÇALAR SPARE PARTS			
	h=H	b	L	f		Sıkma Vidası Clamp Screw	Altık Shim	Altık Vidası Shim Screw	Anahtar Torx Key
<b>SRGCR/L</b>							-	-	
1616 H06	16	16	100	20	RC.T 0602..	SSV M2.5x6 9505			T08
2020 K06	20	20	125	25					
2525 M06	25	25	150	30					
1616 H08	16	16	100	20	RC.T 0803..	SSV M3x8 9508			T08
2020 K08	20	20	125	25					
2525 M08	25	25	150	30					
3232 P08	32	32	170	38	RC.T 1003..	SSV M3.5x10 9511			T15
1616 H10	16	16	100	20					
2020 K10	20	20	125	25					
2525 M10	25	25	150	30	RC.T 1204..				T15
3232 P10	32	32	170	38					
2020 K12	20	20	125	25					
2525 M12	25	25	150	30	RC.T 1605..	SSV M5x13 9519			T20
3232 P12	32	32	170	38					
2525 M16	25	25	150	30					
3232 P16	32	32	170	38	RC.T 2006..	SSV M6x16 9520			T20
2525 M20	25	25	150	30					
3232 P20	32	32	170	38					





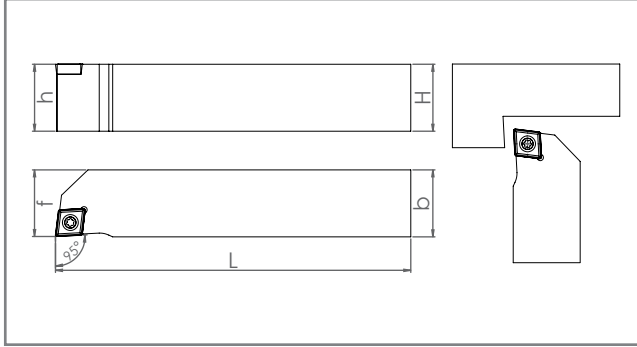

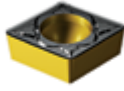
KOD CODE	ÖLÇÜLER DIMENSION (mm)				KESİCİ UÇ INSERT	YEDEK PARÇALAR SPARE PARTS			
	h=H	b	L	f		Sıkma Vidası Clamp Screw	Altık Shim	Altık Vidası Shim Screw	Anahtar Torx Key
<b>STGCR/L-K.O</b>							-	-	
1212 K11	12	12	125	12	TCM.1103	SSV M2.5x6 9505			T08
1616 K11	16	16	125	16					
1616 K16	16	16	125	16	TCM.1604	SSV M3.5x10 9511			T15
2020 K16	20	20	125	20					

## S SİSTEM DIŞ TORNA KATERLERİ S System External Lathe Tool Holders

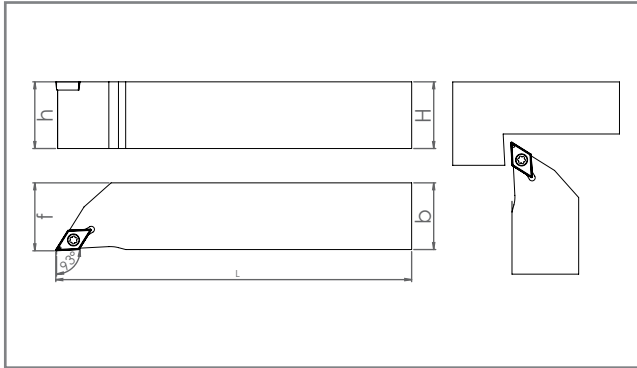

KOD CODE	ÖLÇÜLER DIMENSION (mm)				KESİCİ UÇ INSERT	YEDEK PARÇALAR SPARE PARTS			
	h=H	b	L	f		Sıkma Vidası Clamp Screw	Altık Shim	Altık Vidası Shim Screw	Anahtar Torx Key
<b>SCLCR/L-K.O</b>							-	-	
1010 K06	10	10	125	10	CCM. 0602..	SSV M2.5x6 9505	-	-	T08
1212 G06	12	12	90	12					
1212 K06	12	12	125	12					
1616 F06	16	16	75	16					
1616 K06	16	16	125	16					
1212 G09	12	12	90	12	CCM. 09T3..	SSV M3.5x10 9511	-	-	T15
1212 K09	12	12	125	12					
1616 F09	16	16	75	16					
1616 K09	16	16	125	16					
2020 K09	20	20	125	20					







KOD CODE	ÖLÇÜLER DIMENSION (mm)				KESİCİ UÇ INSERT	YEDEK PARÇALAR SPARE PARTS			
	h=H	b	L	f		Sıkma Vidası Clamp Screw	Altık Shim	Altık Vidası Shim Screw	Anahtar Torx Key
<b>SDJCR/L-K.O</b>							-	-	
1010 K07	10	10	125	10	DCM. 0702..	SSV M2.5x6 9505	-	-	T08
1212 G07	12	12	90	12					
1212 K07	12	12	125	12					
1616 F07	16	16	75	16					
1616 K07	16	16	125	16					
2020 K07	20	20	125	20	DCM. 11T3..	SSV M3.5x10 9511	-	-	T15
1212 G11	12	12	90	12					
1212 K11	12	12	125	12					
1616 F11	16	16	75	16					
1616 K11	16	16	125	16					
2020 K11	20	20	125	20					



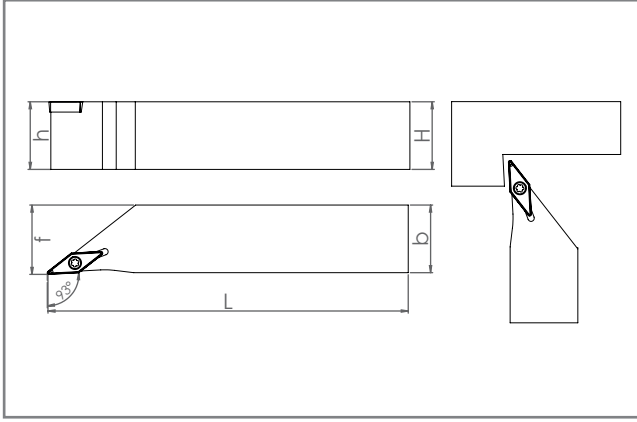



## S SİSTEM KAYAR OTOMAT TAKIMLARI

### S System Automatic Type Lathe Tool Holders

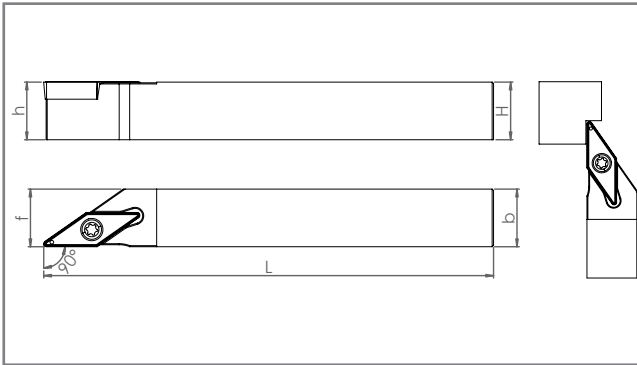

KOD CODE	ÖLÇÜLER DIMENSION (mm)				KESİCİ UÇ INSERT	YEDEK PARÇALAR SPARE PARTS			
	h=H	b	L	f		Sıkma Vidası Clamp Screw	Altık Shim	Altık Vidası Shim Screw	Anahtar Torx Key
<b>SVJBR/L-K.O</b>	h=H	b	L	f			-	-	
1010 K11	10	10	125	10	VBM. 1103..	SSV M2.5x6 9505			T08
1212 G11	12	12	90	12					
1212 K11	12	12	125	12					
1616 F11	16	16	75	16					
1616 K11	16	16	125	16					
2020 K11	20	20	125	20					



KOD CODE	ÖLÇÜLER DIMENSION (mm)				KESİCİ UÇ INSERT	YEDEK PARÇALAR SPARE PARTS			
	h=H	b	L	f		Sıkma Vidası Clamp Screw	Altık Shim	Altık Vidası Shim Screw	Anahtar Torx Key
<b>SVACR/L-K.O</b>	h=H	b	L	f			-	-	
1212 K11	12	12	125	12	VC.T 1103..	SSV M2.5x6 9505			T08
1616 K11	16	16	125	16					
1616 K16	16	16	125	16	VC.T 1604..	SSV M3.5x10 9511			T15
2020 K16	20	20	125	20					

## TIRTIR ve PUNTALAMA TAKIMLARI

### Center Tools

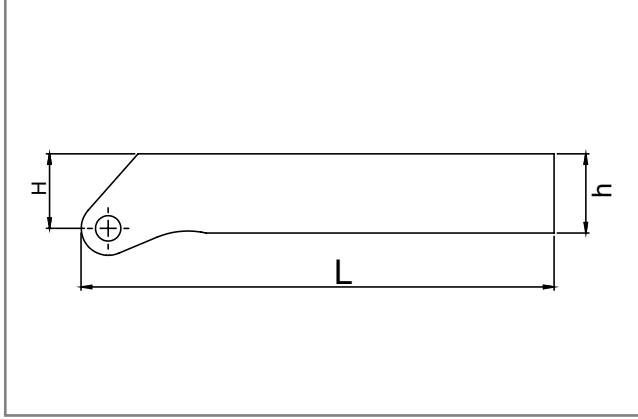

KOD CODE	ÖLÇÜLER DIMENSION (mm)			YEDEK PARÇALAR SPARE PARTS	
<b>CNC PUNTA CENTERING TOOLS</b>	<b>h</b>	<b>H</b>	<b>L</b>		
2020 CCT 2.5x6	20	20	125	SNSV M5x8 9306	AA2.5
2020 CCT 2.5x6.30	20	20	125		
2525 CCT 2.5x6.30	25	25	150		
2525 CCT 2.5x6	25	25	150		
2020 CCT 3.15x8	20	20	125		
2525 CCT 3.15x8	25	25	150		
2020 CCT 4x10	20	20	125		
2525 CCT 4x10	25	25	150	SNSV M6x10 9308	AA3

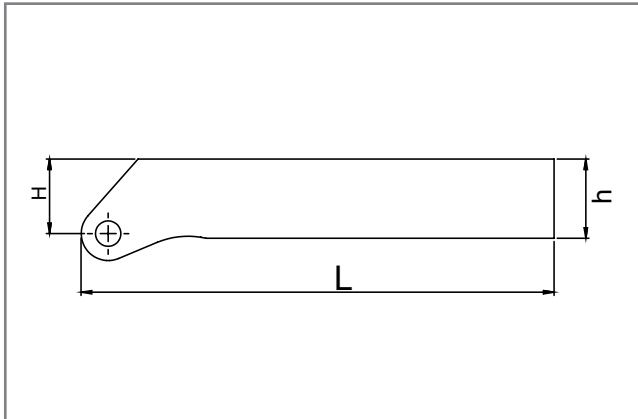

KOD CODE	ÖLÇÜLER DIMENSION (mm)			YEDEK PARÇALAR SPARE PARTS	
<b>CNC TIRTIR CNC KNURLING TOOLS</b>	<b>h</b>	<b>H</b>	<b>L</b>	<b>PİM / PIN</b>	
2525 CKTT	25	25	150	TMP2 6x24-9315	
2020 CKTT	20	20	125	TMP1 6x20-9314	

**Teknoloji profesyonellikle birleŖti**  
Technology combined with professionalism

[www.smoXH.com.tr](http://www.smoXH.com.tr)

## **T SİSTEM DELİK TORNA KATERLERİ**

T System Boring Bars



## İç çap Tornalama Takım Tutucu kodlamaları / Internal tool Holder Code System(ISO)

1	2	3	4	5	6	7	8	9
<b>S</b>	<b>25</b>	<b>S</b>	<b>T</b>	<b>D</b>	<b>U</b>	<b>N</b>	<b>R</b>	<b>- 15</b>
Takım tipi Type of tools	Takım çapı Diameter of tool	Takım boyu Length of tool	Elmas Sıkma sistemi Clamping system of insert	Elmas şekli Shape of insert	Takım kesme açısı Cutting angle of tools	Elmas boşaltma açısı Clearance Angle of insert	Takım yönü Hand of tools	Elmas kesme uzunluğu Length of Insert Cutting Edge

### 1 Takım tipi / Type of tool S 25 S T D U N R - 15

A=Çelik gövdeli içten su vermeli / A=Steel body and with coolant hole  
S=Çelik gövdeli / A=Steel body

### 3 Takım boyu / Length of tools S 25 S T D U N R - 15

length(L) (mm)	length(L) (mm)
H 100	S 250
K 125	T 300
M 150	U 350
N 160	V 400
R 200	

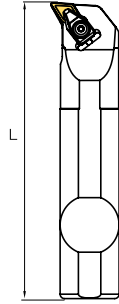

### 2 Takım çapı / Diameter of tool S 25 S T D U N R - 15

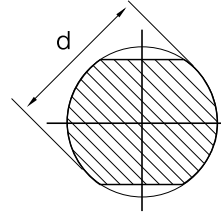

### 4 Elmas sıkma sistemi / Clamping system of insert S 25 S T D U N R - 15

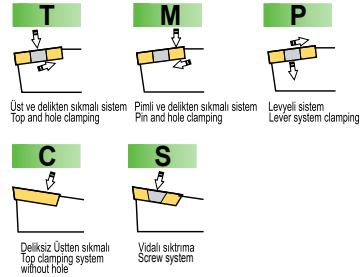

### 6 Takım kesme açısı / Cutting angle of tool S 25 S T D U N R - 15

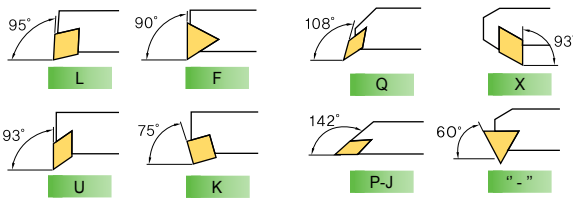

### 5 Takım kesme açısı / Cutting angle of tool S 25 S T D U N R - 15

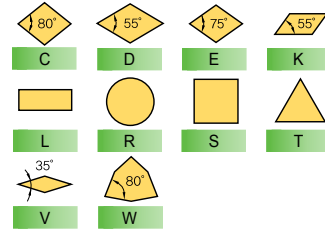

### 7 Şaft Geniřliđi / Height of Shank S 25 S T D U N R - 15

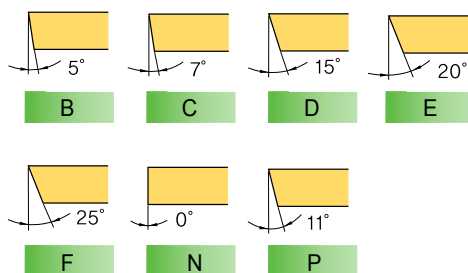

### 8 Takım yönü / Hand of tool S 25 S T D U N R - 15

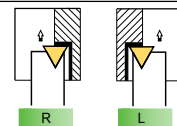





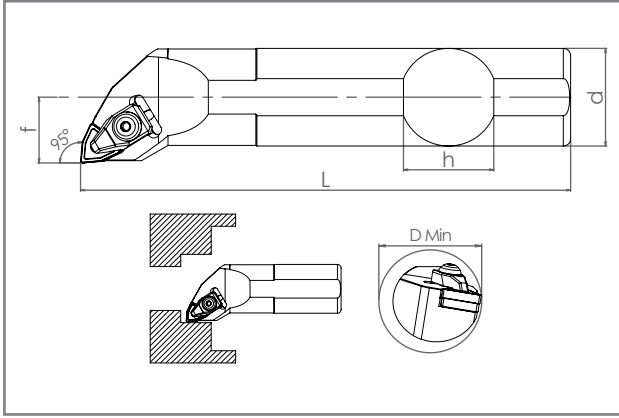

### 9 Elmas kesme yönü / Length of Insert Cutting Edge S 25 S T D U N R - 15







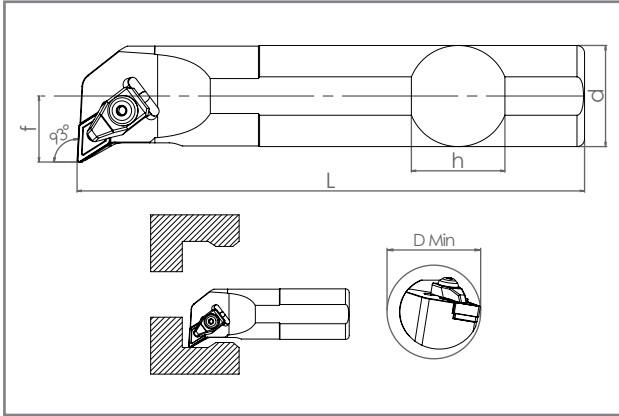

## T SİSTEM DELİK TORNA KATERLERİ T System Boring Bars



KOD CODE	ÖLÇÜLER DIMENSION (mm)					KESİCİ UÇ INSERT	YEDEK PARÇALAR SPARE PARTS					
	d	h	L	f	D min		Baskı Parçası Clamp	Baskı Vidası Screw	Altılık Shim	Altılık Vidası Shim Screw	Pul Stamp	Anahtar Allen Key
<b>TWLNRL</b>												
<b>S20R TWLNR/L-06</b> <span style="color: green; font-weight: bold;">NEW</span>	20	18	200	15	≥25	WNM.0604..	TSK6 9106	TSBV M5x18 9201	-	-	-	AA3
S25S TWLNR/L-06	25	23	250	19.5	≥32		TSK2 9102	TSBV M5X24 9202	BAX WN06 9606	CSAV M3x10 9401		
S32T TWLNR/L-06	32	30	300	24	≥40							
S25S TWLNR/L-08	25	23	250	19.5	≥32	WNM.0804..	TSK1 9101	TSBV M6x30 9205	BAX WN08 9607	TSAV M4x10 9403	TSP 6.5X12 9705	AA3
S32T TWLNR/L-08	32	30	300	24	≥40							
S40U TWLNR/L-08	40	37	350	30	≥50							
S50V TWLNR/L-08	50	47	400	38	≥63							



KOD CODE	ÖLÇÜLER DIMENSION (mm)					KESİCİ UÇ INSERT	YEDEK PARÇALAR SPARE PARTS					
	d	h	L	f	D min		Baskı Parçası Clamp	Baskı Vidası Screw	Altılık Shim	Altılık Vidası Shim Screw	Pul Stamp	Anahtar Allen Key
<b>TDUNR/L</b>												
S25S TDUNR/L-11	25	23	250	19.5	≥32	DNM.1104..	TSK2 9102	TSBV M5X24 9202	BAX DN11 9601	TSAV M4x10x6 9402	-	AA3
S32T TDUNR/L-11	32	30	300	24	≥40							
S25S TDUNR/L-15	25	23	250	19.5	≥32	DNM.1506..	TSK1 9101	TSBV M6x30 9205	BAX DN15 9602	TSAV M4x10 9403	TSP 6.5X12 9705	AA3
S32T TDUNR/L-15	32	30	300	24	≥40							
S40U TDUNR/L-15	40	37	350	30	≥50							
S50V TDUNR/L-15	50	47	400	38	≥63							

## T SİSTEM DELİK TORNA KATERLERİ

### T System Boring Bars

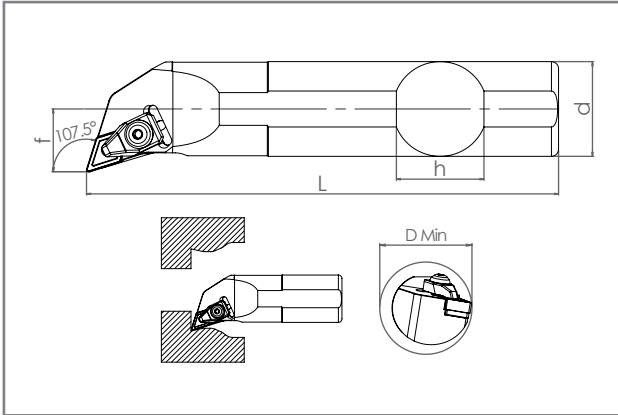



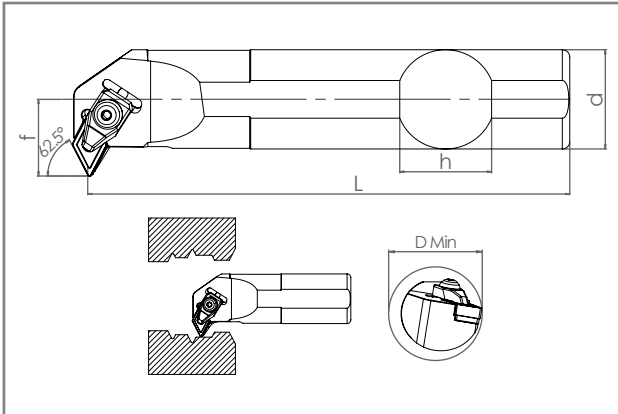



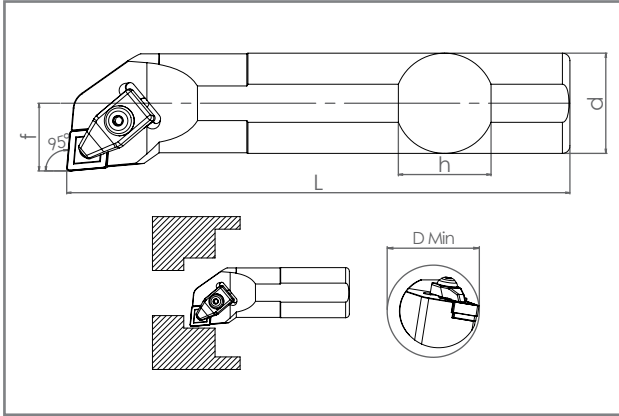

KOD CODE	ÖLÇÜLER DIMENSION (mm)					KESİCİ UÇ INSERT	YEDEK PARÇALAR SPARE PARTS					
	d	h	L	f	D min		Baskı Parçası Clamp	Baskı Vidası Screw	Altık Shim	Altık Vidası Shim Screw	Pul Stamp	Anahtar Allen Key
<b>TDQNR/L</b>												
S25S TDQNR/L-11	25	23	250	19.5	≥32	DNM.1104..	TSK2 9102	TSBV M5X24 9202	BAX DN11 9601	TSAV M4x10x6 9402	-	AA3
S32T TDQNR/L-11	32	30	300	24	≥40							
S25S TDQNR/L-15	25	23	250	19.5	≥32	DNM.1506..	TSK1 9101	TSBV M6x30 9205	BAX DN15 9602	TSAV M4x10 9403	TSP 6.5X12 9705	
S32T TDQNR/L-15	32	30	300	24	≥40							
S40U TDQNR/L-15	40	37	350	30	≥50							
S50V TDQNR/L-15	50	47	400	38	≥63							









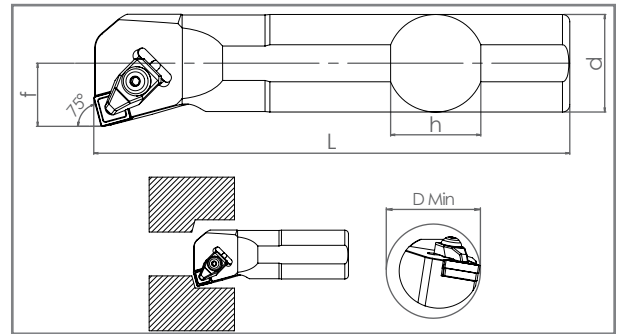

KOD CODE	ÖLÇÜLER DIMENSION (mm)					KESİCİ UÇ INSERT	YEDEK PARÇALAR SPARE PARTS					
	d	h	L	f	D min		Baskı Parçası Clamp	Baskı Vidası Screw	Altık Shim	Altık Vidası Shim Screw	Pul Stamp	Anahtar Allen Key
<b>TD-NR/L</b>												
S25S TD-NR/L-11	25	23	250	19.5	≥32	DNM.1104..	TSK2 9102	TSBV M5X24 9202	BAX DN11 9601	TSAV M4x10x6 9402	-	AA3
S32T TD-NR/L-15	32	30	300	28	≥44							
S40U TD-NR/L-15	40	37	350	32	≥52	DNM.1506..	TSK1 9101	TSBV M6x30 9205	BAX DN15 9602	TSAV M4x10 9403	TSP 6.5X12 9705	
S50V TD-NR/L-15	50	47	400	42	≥67							

## T SİSTEM DELİK TORNA KATERLERİ T System Boring Bars



KOD CODE	ÖLÇÜLER DIMENSION (mm)					KESİCİ UÇ INSERT	YEDEK PARÇALAR SPARE PARTS					
	d	h	L	f	D min		Baskı Parçası Clamp	Baskı Vidası Screw	Altılık Shim	Altılık Vidası Shim Screw	Pul Stamp	Anahtar Allen Key
<b>TCLNR/L</b>												
S20R TCLNR/L-12	20	18	200	15	≥25	CNM.1204..	TSK6 9106	TSBV M5x18 9201	-	-	-	AA3
S25S TCLNR/L-12	25	23	250	19.5	≥32		TSK1 9101	TSBV M6x30 9205	BAX CN12 9603	TSAV M4x10 9403	TSP 6.5X12 9705	
S32T TCLNR/L-12	32	30	300	24	≥40		TSK3 9103	TSBV M6x30x7 9206	BAX CN16 9604	TSAV M6x16x9 9404	-	
S40U TCLNR/L-12	40	37	350	30	≥50		TSK4 9104	TSBV M8x30 9207	BAX CN19 9605	TSAV M6x16x11 9406	-	
S50V TCLNR/L-12	50	47	400	38	≥63							
S32T TCLNR/L-16	32	30	300	24	≥40	CNM..1909..						AA4
S40U TCLNR/L-16	40	37	350	30	≥50							
S50V TCLNR/L-16	50	47	400	38	≥63							
<b>S40U TCLNR/L-19</b> 	<b>40</b>	<b>37</b>	<b>350</b>	<b>30</b>	<b>≥50</b>							
S50V TCLNR/L-19	50	47	400	38	≥63							



KOD CODE	ÖLÇÜLER DIMENSION (mm)					KESİCİ UÇ INSERT	YEDEK PARÇALAR SPARE PARTS					
	d	h	L	f	D min		Baskı Parçası Clamp	Baskı Vidası Screw	Altılık Shim	Altılık Vidası Shim Screw	Pul Stamp	Anahtar Allen Key
<b>TSKNR/L</b>												
S25S TSKNR/L-12	25	23	250	19.5	≥32	SNM.1204..	TSK1 9101	TSBV M6x30 9205	BAX SN12 9608	TSAV M4x10 9403	TSP 6.5X12 9705	AA3
S32T TSKNR/L-12	32	30	300	24	≥40		TSK3 9103	TSBV M6x30x7 9206	BAX SN15 9609	TSAV M6x16x10 9405	-	AA4
S40U TSKNR/L-12	40	37	350	30	≥50							
S50V TSKNR/L-12	50	47	400	38	≥63							
S32T TSKNR/L-15	32	30	300	24	≥40	SNM.1508						AA4
S40U TSKNR/L-15	40	37	350	30	≥50							
S50V TSKNR/L-15	50	47	400	38	≥63							

## T SİSTEM DELİK TORNA KATERLERİ

### T System Boring Bars

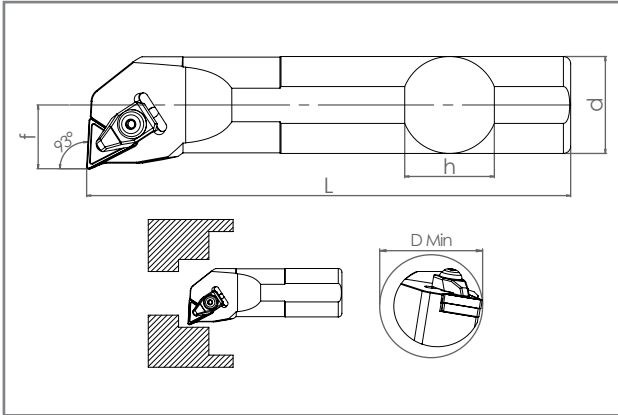

KOD CODE	ÖLÇÜLER DIMENSION (mm)					KESİCİ UÇ INSERT	YEDEK PARÇALAR SPARE PARTS					
	d	h	L	f	D min		Baskı Parçası Clamp	Baskı Vidası Screw	Altık Shim	Altık Vidası Shim Screw	Pul Stamp	Anahtar Allen Key
<b>TTUNR/L</b>												
S25S TTUNR/L-16	25	23	250	19.5	≥32	TNM.1604..	TSK2 9102	TSBV M5X24 9202	BAX TN16 9610	TSAV M4x10x6 9402	-	AA3
S32T TTUNR/L-16	32	30	300	24	≥40		TSK1 9101	TSBV M6x30 9205	BAX TN22 9611	TSAV M4x10 9403	TSP 6.5X12 9705	
S32T TTUNR/L-22	32	30	300	24	≥40	TNM.2204..						
S40U TTUNR/L-22	40	37	350	30	≥50							
S50V TTUNR/L-22	50	47	400	38	≥63							

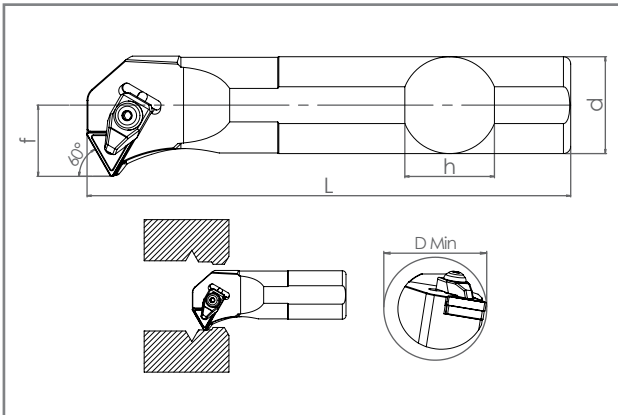





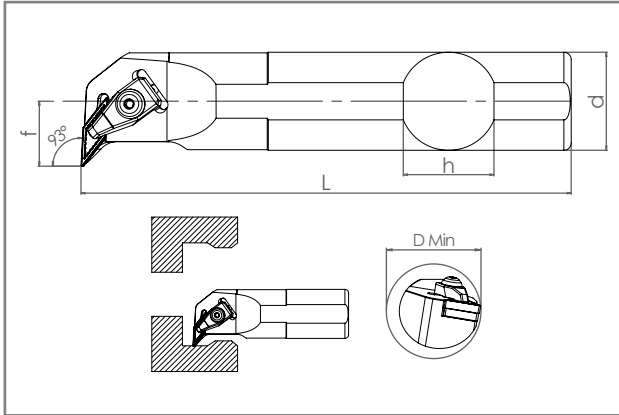

KOD CODE	ÖLÇÜLER DIMENSION (mm)					KESİCİ UÇ INSERT	YEDEK PARÇALAR SPARE PARTS					
	d	h	L	f	D min		Baskı Parçası Clamp	Baskı Vidası Screw	Altık Shim	Altık Vidası Shim Screw	Pul Stamp	Anahtar Allen Key
<b>TT-NR/L</b>												
S25S TT-NR/L-16	25	23	250	19.5	≥32	TNM.1604..	TSK2 9102	TSBV M5X24 9202	BAX TN16 9610	TSAV M4x10x6 9402	TSP 6.5X12 9705	AA3
S32T TT-NR/L-16	32	30	300	24	≥40							







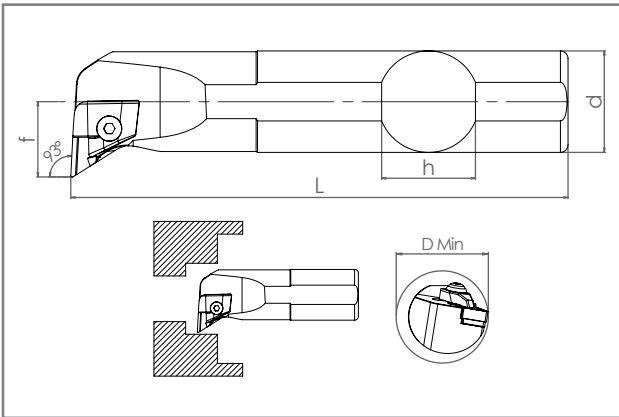

## T SİSTEM DELİK TORNA KATERLERİ T System Boring Bars



KOD CODE	ÖLÇÜLER DIMENSION (mm)					KESİCİ UÇ INSERT	YEDEK PARÇALAR SPARE PARTS					
	d	h	L	f	D min		Baskı Parçası Clamp	Baskı Vidası Screw	Altık Shim	Altık Vidası Shim Screw	Pul Stamp	Anahtar Allen Key
TVUNR/L	d	h	L	f	D min							
S25S TVUNR/L-16	25	23	250	19.5	≥32	VNM.1604..	TSK2 9102	TSBV M5x24 9202	BAX VN16 9612	TSAV M4x10x6 9402	-	AA3
S32T TVUNR/L-16	32	30	300	24	≥40		TSK5 9105	TSBV M6x30 9205		TSAV M4x10 9403	TSP 6.5X12 9705	
S40U TVUNR/L-16	40	37	350	30	≥50							
S50V TVUNR/L-16	50	47	400	38	≥63							



KOD CODE	ÖLÇÜLER DIMENSION (mm)					KESİCİ UÇ INSERT	YEDEK PARÇALAR SPARE PARTS				
	d	h	L	f	D min		Baskı Parçası Clamp	Baskı Vidası Screw	Altık Shim	Altık Vidası Shim Screw	Anahtar Allen Key
CKUNR/L	d	h	L	f	D min						
S25S CKUNR/L-16	25	23	250	21.5	≥34	KNUX 1604..	CSK1/R-9111 CSK1/L-9119	CSBV M6x20-9209	BAX KN/R-16-9621 KN/L-16-9622	CSAV M3x10 9401	AA4
S28S CKUNR/L-16	28	26	290	24	≥38		CSK2/R-9112 CSK3/L-9113	CSBV M6x30-9223			AA5
S32T CKUNR/L-16	32	30	300	24	≥40						
S40U CKUNR/L-16	40	37	350	30	≥50						
S50V CKUNR/L-16	50	47	400	38	≥63						

**Teknoloji profesyonellikle birleŖti**  
Technology combined with professionalism

[www.smoXH.com.tr](http://www.smoXH.com.tr)





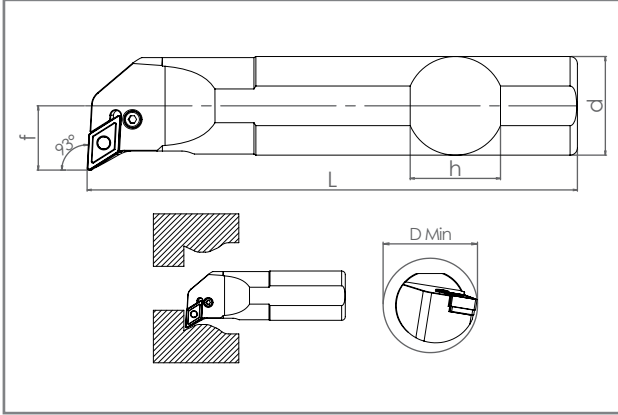

## **P SİSTEM DELİK TORNA KATERLERİ**

P System Boring Bars







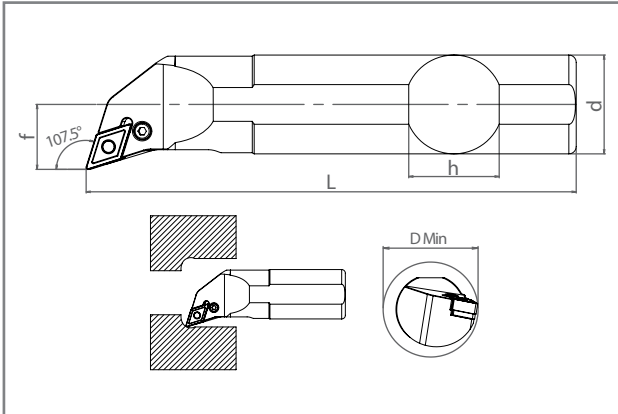

## P SİSTEM DELİK TORNA KATERLERİ P System Boring Bars



KOD CODE	ÖLÇÜLER DIMENSION (mm)					KESİCİ UÇ INSERT	YEDEK PARÇALAR SPARE PARTS				
	d	h	L	f	D min		Levyé Lever	Levyé Vidası Lever Screw	Altık Shim	Altık Yayı Shim Spring	Anahtar Allen Key
<b>PDUNR/L</b>											
S32T PDUNR/L-15	32	30	300	22	≥40	DNM.1506..	SPL4 9123	SLV2 M8x21 9225	BAX DN15 9602	SLAY1 9701	AA3
S40U PDUNR/L-15	40	37.5	350	27	≥50						
S50V PDUNR/L-15	50	47	400	35	≥63						



KOD CODE	ÖLÇÜLER DIMENSION (mm)					KESİCİ UÇ INSERT	YEDEK PARÇALAR SPARE PARTS				
	d	h	L	f	D min		Levyé Lever	Levyé Vidası Lever Screw	Altık Shim	Altık Yayı Shim Spring	Anahtar Allen Key
<b>PDQNR/L</b>											
S25S PDQNR/L-15	25	23	250	17	≥32	DNM.1506..	SPL4 9123	SLV2 M8x21 9225	BAX DN15 9602	SLAY1 9701	AA3
S32T PDQNR/L-15	32	30	300	22	≥40						
S40U PDQNR/L-15	40	37.5	350	27	≥50						
S50V PDQNR/L-15	50	47	400	35	≥63						

## P SİSTEM DELİK TORNA KATERLERİ P System Boring Bars

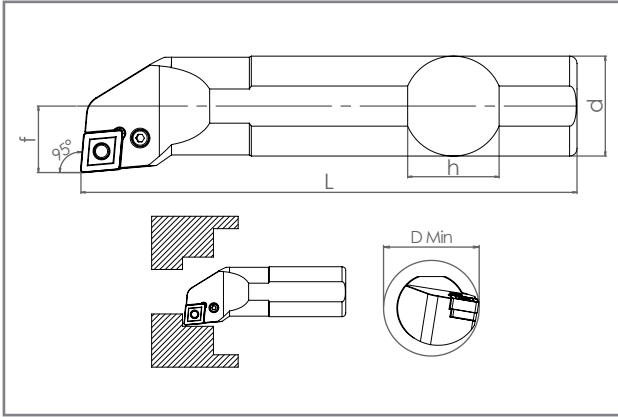

KOD CODE	ÖLÇÜLER DIMENSION (mm)					KESİCİ UÇ INSERT	YEDEK PARÇALAR SPARE PARTS				
	d	h	L	f	D min		Levyeye Lever	Levyeye Vidası Lever Screw	Altılık Shim	Altılık Yayı Shim Spring	Anahtar Allen Key
<b>PCLNR/L</b>											
S25S PCLNR/L-12	25	23	250	17	≥32	CNM.1204..	SPL1 9120	SLV1 M8x19 9224	BAX CN12 9603	SLAY1 9701	AA3
S32T PCLNR/L-12	32	30	300	22	≥40						
S40U PCLNR/L-12	40	37.5	350	27	≥50						
S32T PCLNR/L-16	32	30	300	22	≥40	CNM.1606..	SPL2 9121	SLV2 M8x21 9225	BAX CN16 9604	SLAY2 9702	AA3
S40U PCLNR/L-16	40	37.5	350	27	≥50						
<b>S50V PCLNR/L-16</b>	50	47	400	35	≥63						
S40U PCLNR/L-19	40	37.5	350	27	≥50	CNM.1906..	SPL3 9122	SLV3 M10x28 9226	BAX CN19 9605	SLAY3 9703	AA4
S50V PCLNR/L-19	50	47	400	35	≥63						

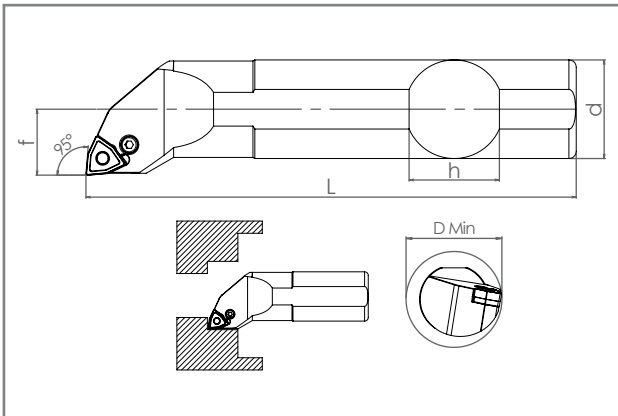





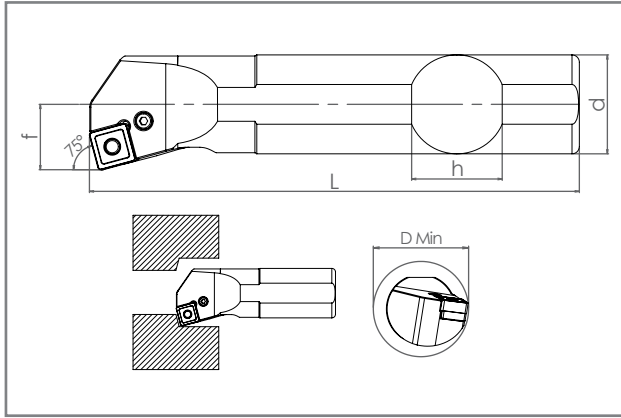

KOD CODE	ÖLÇÜLER DIMENSION (mm)					KESİCİ UÇ INSERT	YEDEK PARÇALAR SPARE PARTS				
	d	h	L	f	D min		Levyeye Lever	Levyeye Vidası Lever Screw	Altılık Shim	Altılık Yayı Shim Spring	Anahtar Allen Key
<b>PWLNR/L</b>											
S25S PWLNR/L-08	25	23	250	17	≥32	WNM.0804..	SPL1 9120	SLV1 M8x19 9224	BAX WN08 9607	SLAY1 9701	AA3
S32T PWLNR/L-08	32	30	300	22	≥40						
S40U PWLNR/L-08	40	37.5	350	27	≥50						
S50V PWLNR/L-08	50	47	400	35	≥63						



## P SİSTEM DELİK TORNA KATERLERİ

### P System Boring Bars



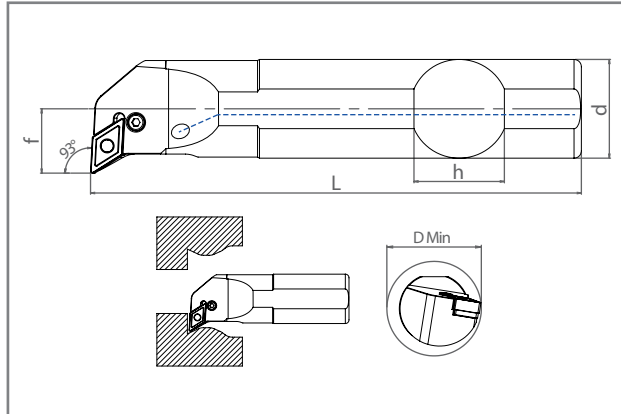





KOD CODE	ÖLÇÜLER DIMENSION (mm)					KESİCİ UÇ INSERT	YEDEK PARÇALAR SPARE PARTS				
	d	h	L	f	D min		Levyeye Lever	Levyeye Vidası Lever Screw	Altık Shim	Altık Yayı Shim Spring	Anahtar Allen Key
<b>PSKNR/L</b>											
S25S PSKNR/L-12	25	23	250	17	≥32	SNM.1204..	SPL1 9120	SLV1 M8x19 9224	BAX SN12 9608	SLAY1 9701	AA3
S32T PSKNR/L-12	32	30	300	22	≥40						
S40U PSKNR/L-12	40	37.5	350	27	≥50						
S32T PSKNR/L-15	32	30	300	22	≥40	SNM.1506..	SPL2 9121	SLV2 M8x21 9225	BAX SN15 9609	SLAY2 9702	
S40U PSKNR/L-15	40	37.5	350	27	≥50						
S50V PSKNR/L-15	50	47	400	35	≥63						

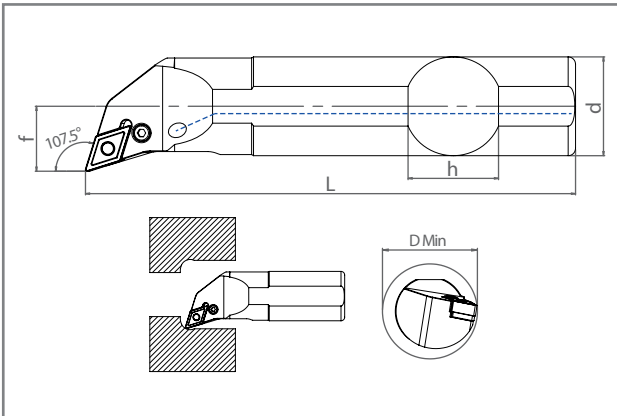





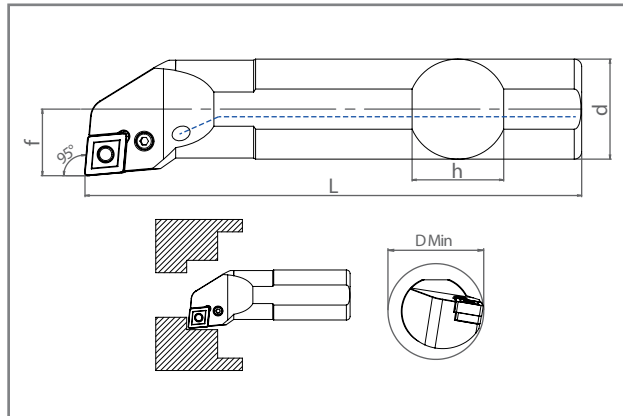

KOD CODE	ÖLÇÜLER DIMENSION (mm)					KESİCİ UÇ INSERT	YEDEK PARÇALAR SPARE PARTS				
	d	h	L	f	D min		Levyeye Lever	Levyeye Vidası Lever Screw	Altık Shim	Altık Yayı Shim Spring	Anahtar Allen Key
<b>A-PDUNR/L</b>											
A32S PDUNR/L-15	32	30	250	22	≥40	DNM.1506..	SPL4 9123	SLV2 M8x21 9225	BAX DN15 9602	SLAY1 9701	AA3

## P SİSTEM DELİK TORNA KATERLERİ P System Boring Bars



KOD CODE	ÖLÇÜLER DIMENSION (mm)					KESİCİ UÇ INSERT	YEDEK PARÇALAR SPARE PARTS				
	d	h	L	f	D min		Levyeye Lever	Levyeye Vidası Lever Screw	Altılık Shim	Altılık Yayı Shim Spring	Anahtar Allen Key
<b>A-PDQNR/L</b>											
A25R PDQNR/L-15	25	23	200	17	≥32	DNM.1506..	SPL4 9123	SLV2 M8x21 9225	BAX DN15 9602	SLAY1 9701	AA3
A32S PDQNR/L-15	32	30	250	22	≥40						



KOD CODE	ÖLÇÜLER DIMENSION (mm)					KESİCİ UÇ INSERT	YEDEK PARÇALAR SPARE PARTS				
	d	h	L	f	D min		Levyeye Lever	Levyeye Vidası Lever Screw	Altılık Shim	Altılık Yayı Shim Spring	Anahtar Allen Key
<b>A-PCLNR/L</b>											
A25R PCLNR/L-12	25	23	200	17	≥32	CNM.1204..	SPL1 9120	SLV1 M8x19 9224	BAX CN12 9603	SLAY1 9701	AA3
A32S PCLNR/L-12	32	30	250	22	≥40						
A32S PCLNR/L-16	32	30	250	22	≥40	CNM.1606..	SPL2 9121	SLV2 M8x21 9225	BAX CN16 9604	SLAY2 9702	AA5

## P SİSTEM DELİK TORNA KATERLERİ P System Boring Bars

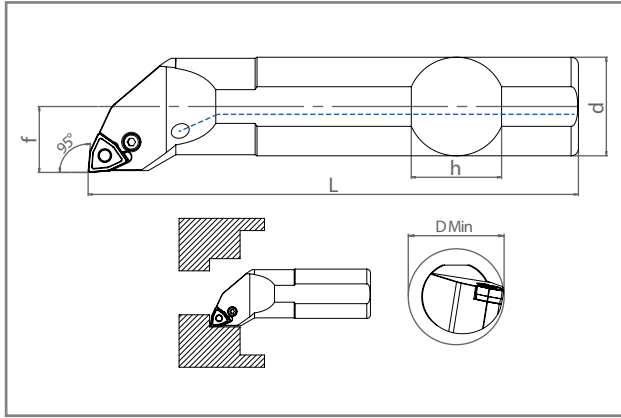

KOD CODE	ÖLÇÜLER DIMENSION (mm)					KESİCİ UÇ INSERT	YEDEK PARÇALAR SPARE PARTS				
	d	h	L	f	D <sub>min</sub>		Levyeye Lever	Levyeye Vidası Lever Screw	Altılık Shim	Altılık Yayı Shim Spring	Anahtar Allen Key
<b>A-PWLNRL</b>											
A25R PWLNRL-08	25	23	200	17	≥32	WNM.0804..	SPL1 9120	SLV1 M8x19 9224	BAX WN08 9607	SLAY1 9701	AA3
A32S PWLNRL-08	32	30	250	22	≥40		SPL2 9121	SLV2 M8x21 9225	BAX SN15 9609	SLAY2 9702	AA5

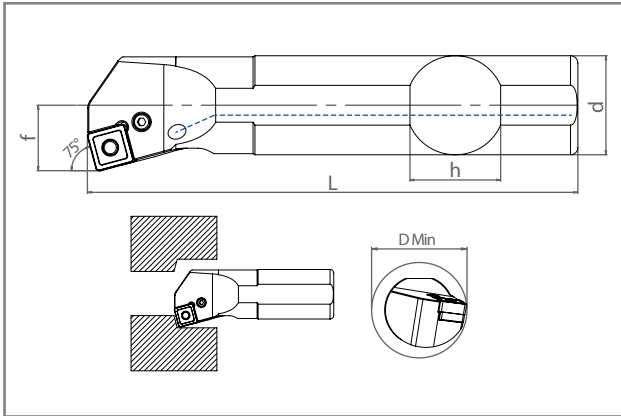

KOD CODE	ÖLÇÜLER DIMENSION (mm)					KESİCİ UÇ INSERT	YEDEK PARÇALAR SPARE PARTS				
	d	h	L	f	D <sub>min</sub>		Levyeye Lever	Levyeye Vidası Lever Screw	Altılık Shim	Altılık Yayı Shim Spring	Anahtar Allen Key
<b>A-PSKNRL</b>											
A25R PSKNRL/L-12	25	23	200	17	≥32	SNM.1204..	SPL1 9120	SLV1 M8x19 9224	BAX SN12 9608	SLAY1 9701	AA3
A32S PSKNRL/L-12	32	30	250	22	≥40		SPL2 9121	SLV2 M8x21 9225	BAX SN15 9609	SLAY2 9702	AA5

**Teknoloji profesyonellikle birleŖti**  
Technology combined with professionalism

[www.smoxx.com.tr](http://www.smoxx.com.tr)

## **M SİSTEM DELİK TORNA KATERLERİ**

M System Boring Bars









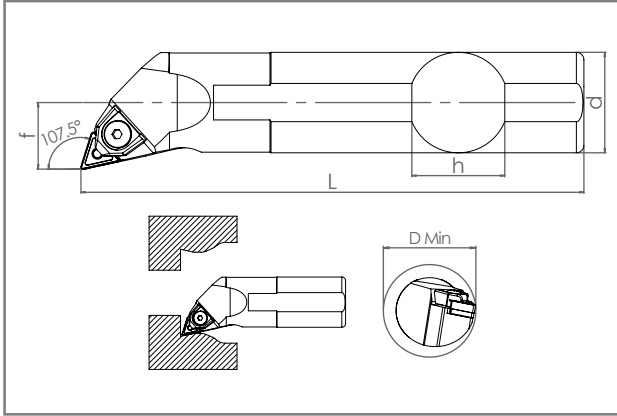







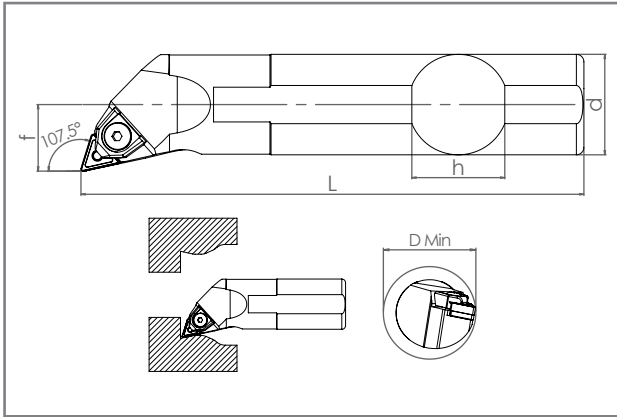

## M SİSTEM DELİK TORNA KATERLERİ

### M System Boring Bars



KOD CODE	ÖLÇÜLER DIMENSION (mm)					KESİCİ UÇ INSERT	YEDEK PARÇALAR SPARE PARTS					
	d	h	L	f	D min		Baskı Parçası Clamp	Baskı Vidası Screw	Altık Shim	Pim Pin	Pul Stamp	Anahtar Allen Key
<b>MTUNR/L</b>												
S20R MTUNR/L-16	20	18	200	15	≥25	TNM.1604..	MSK2 9108	TSBV M5x18 9201	-	BMP5 3.70x5x13 9313	-	AA3
S25S MTUNR/L-16	25	23	250	19.5	≥32		MSK1 9107	TSBV M6x25 9203	BAX TN16 9610	BMP1 3.70x5x16 9309	TSP 6.5x12 9705	
S32T MTUNR/L-16	32	30	300	24	≥40				BAX TN22 9611	BMP2 5x6x16 9310		
S40U MTUNR/L-16	40	37	350	30	≥50	TNM.2204..	MSK1 9107	TSBV M6x30 9205	BAX TN22 9611	BMP2 5x6x16 9310		
S32T MTUNR/L-22	32	30	300	24	≥40							
S40U MTUNR/L-22	40	37	350	30	≥50							
S50V MTUNR/L-22	50	47	400	38	≥63							



KOD CODE	ÖLÇÜLER DIMENSION (mm)					KESİCİ UÇ INSERT	YEDEK PARÇALAR SPARE PARTS					
	d	h	L	f	D min		Baskı Parçası Clamp	Baskı Vidası Screw	Altık Shim	Pim Pin	Pul Stamp	Anahtar Allen Key
<b>MTQNR/L</b>												
S20R MTQNR/L-16	20	18	200	15	≥25	TNM.1604..	MSK2 9108	TSBV M5x18 9201	-	BMP5 3.70x5x13 9319	-	AA3
S25S MTQNR/L-16	25	23	250	19.5	≥32	TNM.1604..	MSK1 9107	TSBV M6x25 9203	BAX TN16 9610	BMP1 3.70x5x16 9309	TSP 6.5x12 9705	
S32T MTQNR/L-16	32	30	300	24	≥40				BAX TN22 9611	BMP2 5x6x16 9310		
S40U MTQNR/L-16	40	37	350	30	≥50	TNM.2204..	MSK1 9107	TSBV M6x30 9205	BAX TN22 9611	BMP2 5x6x16 9310		
S32T MTQNR/L-22	32	30	300	24	≥40							
S40U MTQNR/L-22	40	37	350	30	≥50							
S50V MTQNR/L-22	50	47	400	38	≥63							

## M SİSTEM DELİK TORNA KATERLERİ M System Boring Bars

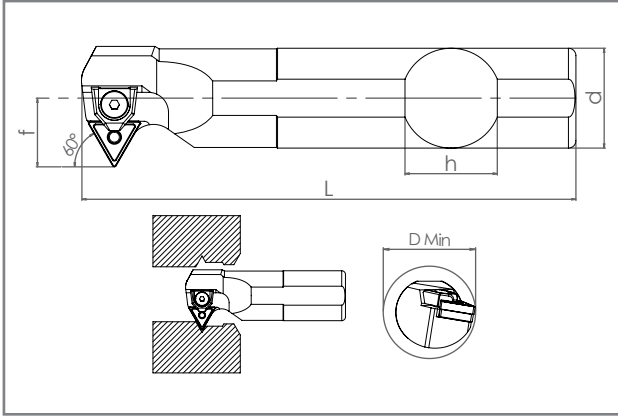

KOD CODE	ÖLÇÜLER DIMENSION (mm)					KESİCİ UÇ INSERT	YEDEK PARÇALAR SPARE PARTS					
	d	h	L	f	D min		Baskı Parçası Clamp	Baskı Vidası Screw	Altık Shim	Pim Pin	Pul Stamp	Anahtar Allen Key
<b>MT-NR/L</b>												
S25S MT-NR-16	25	23	250	19.5	≥32	TNM.1604..	MSK1 9107	TSBV M6x25 9203	BAX TN16 9610	BMP5 3.70x5x13 9313	TSP 6.5X12 9705	AA3
S32T MT-NR-16	32	30	300	24	≥40				BAX TN22 9611	BMP1 3.70x5x16 9309		
S40U MT-NR-16	40	37	350	30	≥50	TNM.2204..	MSK1 9107	TSBV M6x30 9205	BAX TN22 9611	BMP2 5x6x16 9310	TSP 6.5X12 9705	AA3
S32T MT-NR-22	32	30	300	24	≥40							
S40U MT-NR-22	40	37	350	30	≥50							
S50V MT-NR-22	50	47	400	38	≥63							

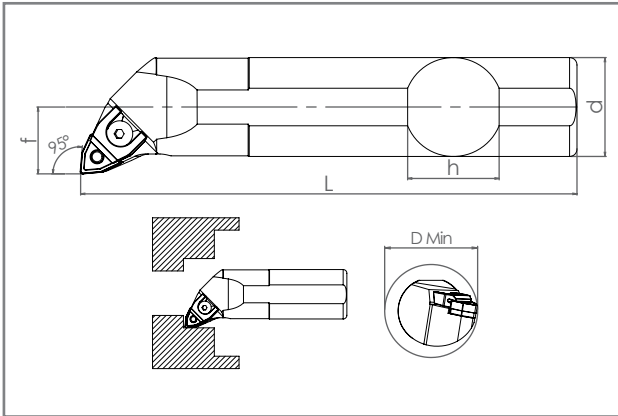

KOD CODE	ÖLÇÜLER DIMENSION (mm)					KESİCİ UÇ INSERT	YEDEK PARÇALAR SPARE PARTS					
	d	h	L	f	D min		Baskı Parçası Clamp	Baskı Vidası Screw	Altık Shim	Pim Pin	Pul Stamp	Anahtar Allen Key
<b>MWLNR/L</b>												
S16P MWLNR/L-06	16	15	170	11	≥21	WNM.0604..	MSK4 9110	TSBV M5x16 9222	-	BMP1 3.70x5x16 9309	-	AA3
S20R MWLNR/L-06	20	18	200	15	≥25				BAX WN06 9606			
S25S MWLNR/L-06	25	23	250	19.5	≥32	WNM.0804..	MSK4 9110	TSBV M5x18 9201	-	BPM6 5x6x14 9316	TSP 6.5X12 9705	AA3
S25S MWLNR/L-08	25	23	250	19.5	≥32							
S32T MWLNR/L-08	32	30	300	24	≥40				BAX WN08 9607	BPM6 5x6x14 9316		
S40U MWLNR/L-08	40	37	350	30	≥50			TSBV M6x30 9205	BPM3 5x6 9311			
S50V MWLNR/L-08	50	47	400	38	≥63							

**Teknoloji profesyonellikle birleŖti**  
Technology combined with professionalism

[www.smoxh.com.tr](http://www.smoxh.com.tr)

## **S SİSTEM DELİK TORNA KATERLERİ**

S System Boring Bars



## S SİSTEM DELİK TORNA KATERLERİ S System Boring Bars

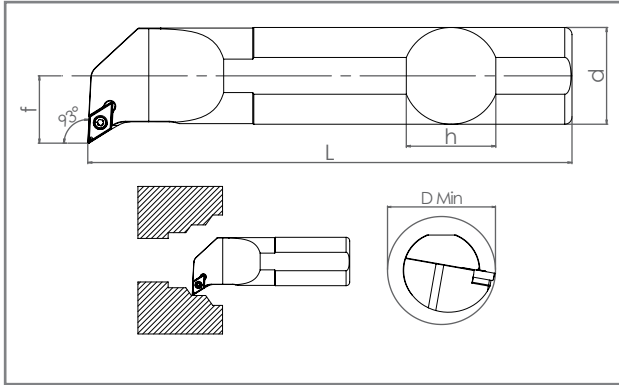

KOD CODE	ÖLÇÜLER DIMENSION (mm)						KESİCİ UÇ INSERT	YEDEK PARÇALAR SPARE PARTS			
	d	h	L	f	L1	D min		Sıkma Vidası Clamp Screw	Altık Shim	Altık Vidası Shim Screw	Anahtar Torx Key
<b>SDUCR/L</b>											
S10K SDUCR/L-07	10	09	125	08	-	≥13	DCM. 0702..	SSV M2.5x6 9505	-	-	T08
S10x16P SDUCR/L-07	16	15	150	08	35	≥13					
S12K SDUCR/L-07	12	11	125	10	-	≥16					
S12x16P SDUCR/L-07	16	15	150	10	35	≥16					
S16P SDUCR/L-07	16	15	170	13	-	≥21					
<b>S20R SDUCR/L-07</b>	<b>20</b>	<b>18</b>	<b>200</b>	<b>15</b>	-	<b>25</b>	DCM. 11T3..	SSV M3.5x10 9511	BAX DC11 9613	SBV2 M5.05 A3.5x9 9408 SBV M5.05 A3.5x11 9407	T15
S16P SDUCR/L-11	16	15	170	13	-	≥21					
S20R SDUCR/L-11	20	18	200	15	-	≥25					
S25S SDUCR/L-11	25	23	250	19.5	-	≥32					
S25S SDUCR/L-11S	25	23	250	19.5	-	≥32					
S32T SDUCR/L-11	32	30	300	24	-	≥40	SSV M3.5x14 9512				
S40U SDUCR/L-11	40	37	350	30	-	≥50					

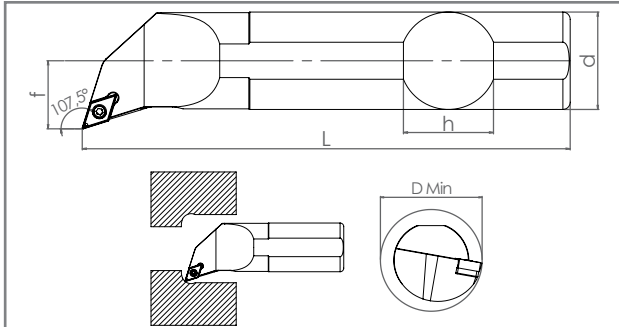





KOD CODE	ÖLÇÜLER DIMENSION (mm)						KESİCİ UÇ INSERT	YEDEK PARÇALAR SPARE PARTS			
	d	h	L	f	L1	D min		Sıkma Vidası Clamp Screw	Altık Shim	Altık Vidası Shim Screw	Anahtar Torx Key
<b>SDQCR/L</b>											
S10K SDQCR/L-07	10	09	125	08	-	≥13	DCM. 0702..	SSV M2.5x6 9505	-	-	T08
S10x16P SDQCR/L-07	16	15	150	08	35	≥13					
S12K SDQCR/L-07	12	11	125	10	-	≥16					
S12x16P SDQCR/L-07	16	15	150	10	35	≥16					
S16P SDQCR/L-07	16	15	170	13	-	≥21					
<b>S20R SDQCR/L-07</b>	<b>20</b>	<b>18</b>	<b>200</b>	<b>15</b>	-	<b>25</b>	DCM. 11T3..	SSV M3.5x10 9511	BAX DC11 9613	SBV2 M5.05 A3.5x9 9408 SBV M5.05 A3.5x11 9407	T15
S16P SDQCR/L-11	16	15	170	13	-	≥21					
S20R SDQCR/L-11	20	18	200	15	-	≥25					
S25S SDQCR/L-11	25	23	250	19.5	-	≥32					
<b>S25S SDQCR/L-11S</b>	<b>25</b>	<b>23</b>	<b>250</b>	<b>19.5</b>	-	<b>≥32</b>					
S32T SDQCR/L-11	32	30	300	24	-	≥40	SSV M3.5x14 9512				
S40U SDQCR/L-11	40	37	350	30	-	≥50					

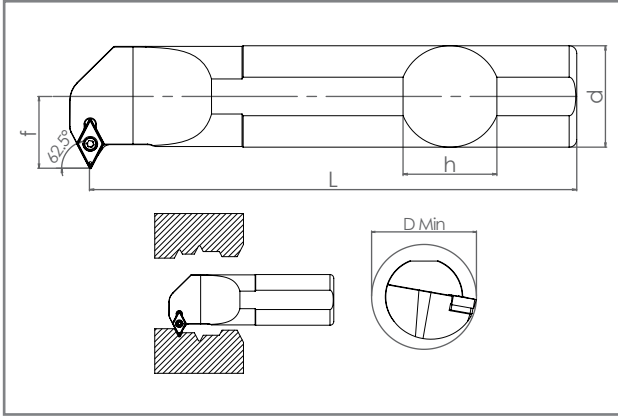

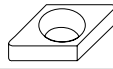

## S SİSTEM DELİK TORNA KATERLERİ

### S System Boring Bars

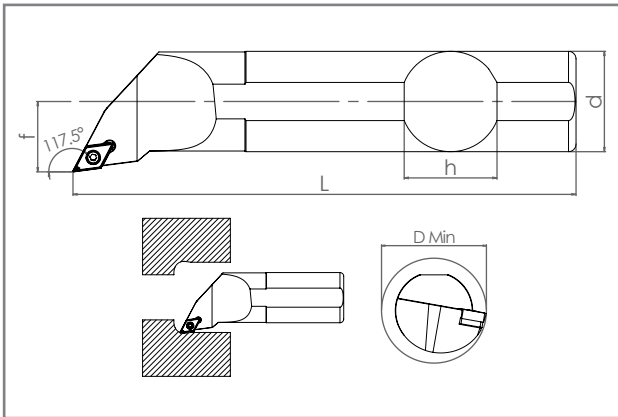

KOD CODE	ÖLÇÜLER DIMENSION (mm)						KESİCİ UÇ INSERT	YEDEK PARÇALAR SPARE PARTS			
	d	h	L	f	L1	D min		Sıkma Vidası Clamp Screw	Altık Shim	Altık Vidası Shim Screw	Anahtar Torx Key
<b>SD-CR/L</b>											
<b>S10K SD-CR/L-07</b>	10	09	125	08	-	≥14	DCM. 0702..	SSV M2.5x6 9505	-	-	T08
S12K SD-CR/L-07	12	11	125	11	-	≥17					
S12x16P SD-CR/L-07	16	15	150	11	35	≥17					
S16P SD-CR/L-11	16	15	170	13	-	≥21	DCM. 11T3..	SSV M3.5x10 9511	-	-	T15
S20R SD-CR/L-11	20	18	200	15	-	≥25					
S25S SD-CR/L-11	25	23	250	19.5	-	≥32					
S32T SD-CR/L-11	32	30	300	24	-	≥40					
S40U SD-CR/L-11	40	37	350	30	-	≥50					

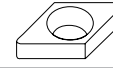

KOD CODE	ÖLÇÜLER DIMENSION (mm)						KESİCİ UÇ INSERT	YEDEK PARÇALAR SPARE PARTS			
	d	h	L	f	D min	Sıkma Vidası Clamp Screw		Altık Shim	Altık Vidası Shim Screw	Anahtar Torx Key	
<b>SDPCR/L</b>											
S10K SDPCR/L-07	10	09	125	08	≥13	DCM. 0702..	SSV M2.5x6 9505	-	-	T08	
S12K SDPCR/L-07	12	11	125	10	≥16						
S16P SDPCR/L-11	16	15	170	13	≥21						
S20R SDPCR/L-11	20	18	200	15	≥25	DCM. 11T3..	SSV M3.5x10 9511	-	-	T15	
S25S SDPCR/L-11	25	23	250	19.5	≥32						
<b>S25S SDPCR/L-11S</b>	25	23	250	19.5	≥32						
S32T SDPCR/L-11	32	30	300	24	≥40						
S40U SDPCR/L-11	40	37	350	30	≥50						

## S SİSTEM DELİK TORNA KATERLERİ S System Boring Bars

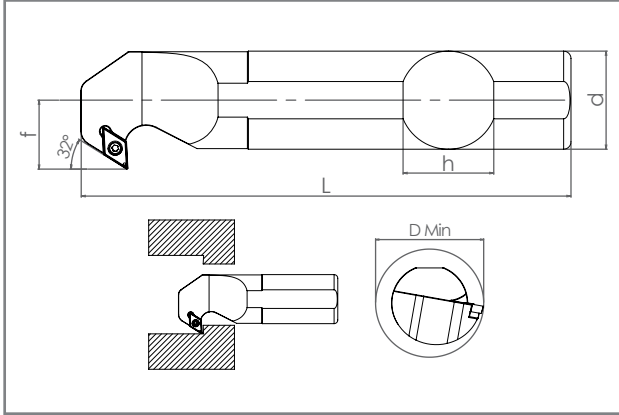



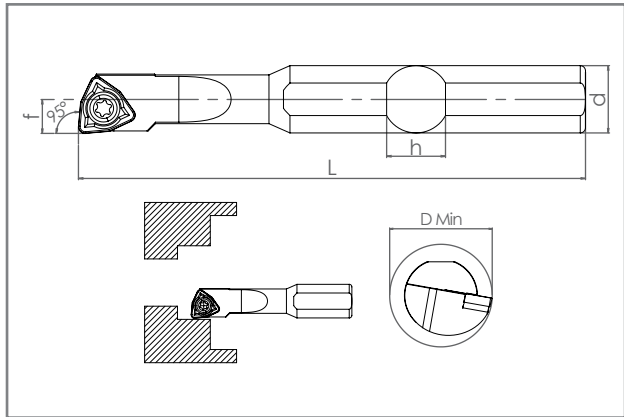





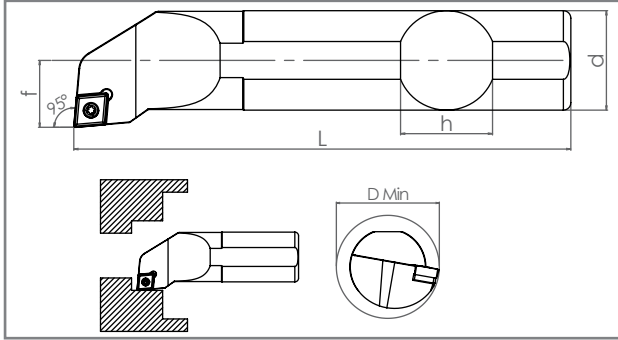

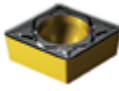

KOD CODE	ÖLÇÜLER DIMENSION (mm)					KESİCİ UÇ INSERT	YEDEK PARÇALAR SPARE PARTS			
	d	h	L	f	D min		Sıkma Vidası Clamp Screw	Altık Shim	Altık Vidası Shim Screw	Anahtar Torx Key
<b>SDXCRL</b>										
S12K SDXCRL-07	12	11	125	11	≥17	DCM. 0702..	SSV M2.5x6 9505			T08
S16P SDXCRL-11	16	15	170	13	≥21	DCM. 11T3..	SSV M3.5x10 9511	-	-	T15
S20R SDXCRL-11	20	18	200	15	≥25					
S25S SDXCRL-11	25	23	250	19.5	≥32					
S32T SDXCRL-11	32	30	300	24	≥40					
S40U SDXCRL-11	40	37	350	30	≥50		SSV M3.5x14 9512	BAX DC11 9613	SBV M5.05 A3.5x11 9407	











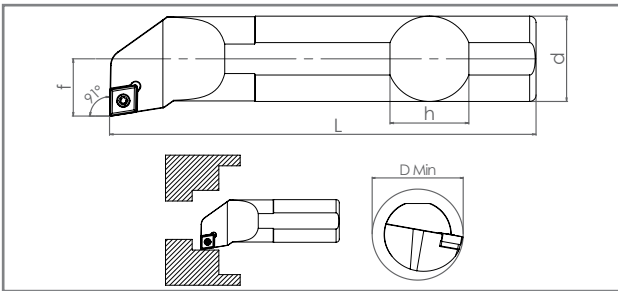

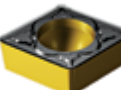

KOD CODE	ÖLÇÜLER DIMENSION (mm)						KESİCİ UÇ INSERT	YEDEK PARÇALAR SPARE PARTS			
	d	h	L	f	L1	D min		Sıkma Vidası Clamp Screw	Altık Shim	Altık Vidası Shim Screw	Anahtar Torx Key
<b>SWLCR/L</b>									-	-	
S0608H SWLCR/L-03	08	05	100	04	30	≥08	WCM.0302..	SSV M2.5x5 9504	-	-	T08
S0810K SWLCR/L-03	10	07	125	07	30	≥10					

## S SİSTEM DELİK TORNA KATERLERİ S System Boring Bars







KOD CODE	ÖLÇÜLER DIMENSION (mm)						KESİCİ UÇ INSERT	YEDEK PARÇALAR SPARE PARTS			
	d	h	L	f	L1	D min		Sıkma Vidası Clamp Screw	Altık Shim	Altık Vidası Shim Screw	Anahtar Torx Key
<b>SCLCR/L</b>											
S0608H SCLCR/L-06	06	7	100	05	30	≥8	CCM. 0602..	SSV M2.5x5 9504			
S08H SCLCR/L-06	08	7	100	07	-	≥11					
S10K SCLCR/L-06	10	9	125	08	-	≥13					
S10x16P SCLCR/L-06	16	15	150	08	35	≥13					
S12K SCLCR/L-06	12	11	125	10	-	≥16					
S12x16P SCLCR/L-06	16	15	150	10	35	≥13	CCM. 09T3..	SSV M3.5x10 9511			
S12K SCLCR/L-09	12	11	125	10	-	≥16					
S16P SCLCR/L-09	16	15	170	13	-	≥21					
S20R SCLCR/L-09	20	19	200	15	-	≥25					
S25S SCLCR/L-09	25	23	250	19.5	-	≥32					
<b>S25S SCLCR/L-09S</b>	<b>25</b>	<b>23</b>	<b>250</b>	<b>19.5</b>	-	<b>≥32</b>	CCM. 1204..	SSV M3.5x14 9512	BAX CC09 9616	SBV2 M5.05 A3.5x9 9408	
S32T SCLCR/L-09	32	30	300	24	-	≥40					
<b>S25S SCLCR/L-12</b>	<b>25</b>	<b>23</b>	<b>250</b>	<b>19.5</b>	-	<b>≥32</b>					
S32T SCLCR/L-12	32	30	300	24	-	≥40					
S40U SCLCR/L-12	40	37	350	30	-	≥50					



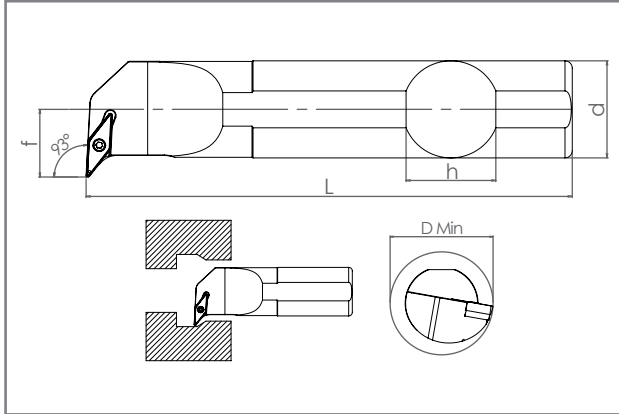

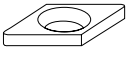

KOD CODE	ÖLÇÜLER DIMENSION (mm)					KESİCİ UÇ INSERT	YEDEK PARÇALAR SPARE PARTS			
	d	h	L	f	D min		Sıkma Vidası Clamp Screw	Altık Shim	Altık Vidası Shim Screw	Anahtar Torx Key
<b>SCFCR/L</b>										
S08H SCFCR/L-06	08	7	100	07	≥11	CCM. 0602..	SSV M2.5x5 9504			
S10K SCFCR/L-06	10	9	125	08	≥13					
S12K SCFCR/L-06	12	11	125	10	≥16					
S12K SCFCR/L-09	12	11	125	10	≥16	CCM. 09T3..	SSV M3.5x10 9511			
S16P SCFCR/L-09	16	15	170	13	≥21					
S20R SCFCR/L-09	20	19	200	15	≥25					
S25S SCFCR/L-09	25	23	250	19.5	≥32	CCM. 1204..	SSV M4x12x6 9517	BAX CC12 9617	SBV1 M6.075 A4x13 9410	
S25S SCFCR/L-12	25	23	250	19.5	≥32					
S32T SCFCR/L-12	32	30	300	24	≥40					
S40U SCFCR/L-12	40	37	350	30	≥50					

## S SİSTEM DELİK TORNA KATERLERİ S System Boring Bars

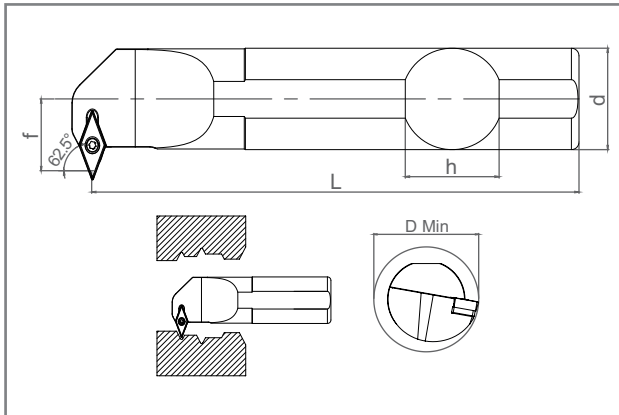

KOD CODE	ÖLÇÜLER DIMENSION (mm)					KESİCİ UÇ INSERT	YEDEK PARÇALAR SPARE PARTS			
	d	h	L	f	D min		Sıkma Vidası Clamp Screw	Altık Shim	Altık Vidası Shim Screw	Anahtar Torx Key
<b>SVUBR/L</b>										
S16P SVUBR/L-11	16	15	170	13	≥21	VBM. 1103..	SSV M2.5x6 9505	-	-	T08
S20R SVUBR/L-11	20	18	200	15	≥25					
S25S SVUBR/L-16	25	23	250	19.5	≥32	VBM. 1604..	SSV M3.5x10 9511	BAX VB16 9618	SBV2 M5.05 A3.5x9 9408 SBV M5.05 A3.5x11 9407	T15
<b>S25S SVUBR/L-16S</b>	<b>25</b>	<b>23</b>	<b>250</b>	<b>19.5</b>	<b>≥32</b>					
S32T SVUBR/L-16	32	30	300	24	≥40					
S40U SVUBR/L-16	40	37	350	30	≥50					

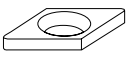







KOD CODE	ÖLÇÜLER DIMENSION (mm)					KESİCİ UÇ INSERT	YEDEK PARÇALAR SPARE PARTS			
	d	h	L	f	D min		Sıkma Vidası Clamp Screw	Altık Shim	Altık Vidası Shim Screw	Anahtar Torx Key
<b>SV-BR/L</b>										
S25S SV-BR/L-16	25	23	250	19.5	≥32	VBM. 1604..	SSV M3.5x10 9511	-	-	T15
S32T SV-BR/L-16	32	30	300	24	≥40					

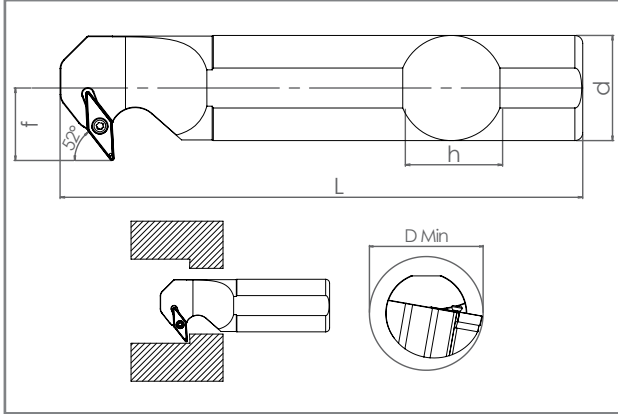





## S SİSTEM DELİK TORNA KATERLERİ

### S System Boring Bars

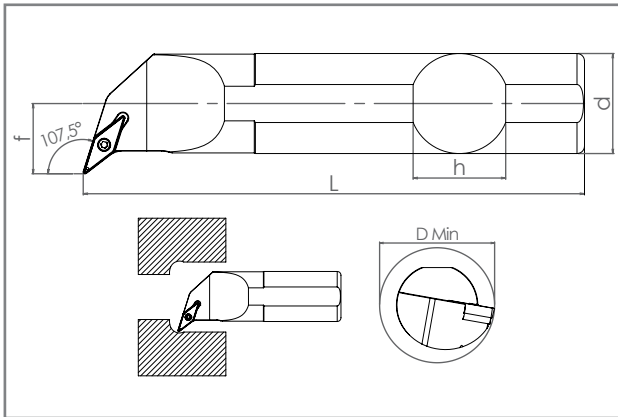

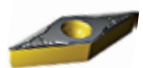
KOD CODE	ÖLÇÜLER DIMENSION (mm)					KESİCİ UÇ INSERT	YEDEK PARÇALAR SPARE PARTS			
	d	h	L	f	D min		Sıkma Vidası Clamp Screw	Altık Shim	Altık Vidası Shim Screw	Anahtar Torx Key
<b>SVXBR/L</b>										
S16P SVXBR/L-11	16	15	170	13	≥21	VBM. 1103..	SSV M2.5x5 9504	-	-	T08
S20R SVXBR/L-11	20	18	200	15	≥25		VBM. 1604..	SSV M3.5x10 9511	BAX VB16 9618	SBV2 M5.05 A3.5x9 9408
S25S SVXBR/L-16	25	23	250	19.5	≥32	SSV M3.5x14 9512		SBV M5.05 A3.5x11 9407		
<b>S25S SVXBR/L-16S</b>	<b>25</b>	<b>23</b>	<b>250</b>	<b>19.5</b>	<b>≥32</b>					
S32T SVXBR/L-16	32	30	300	24	≥40					
S40U SVXBR/L-16	40	37	350	30	≥50					



KOD CODE	ÖLÇÜLER DIMENSION (mm)					KESİCİ UÇ INSERT	YEDEK PARÇALAR SPARE PARTS			
	d	h	L	f	D min		Sıkma Vidası Clamp Screw	Altık Shim	Altık Vidası Shim Screw	Anahtar Torx Key
<b>SVQBR/L</b>										
S16P SVQBR/L-11	16	15	170	13	≥21	VBM. 1103..	SSV M2.5x5 9504	-	-	T08
S20R SVQBR/L-11	20	18	200	15	≥25		VBM. 1604..	SSV M3.5x10 9511	BAX VB16 9618	SBV2 M5.05 A3.5x9 9408
S25S SVQBR/L-16	25	23	250	19.5	≥32	SSV M3.5x14 9512		SBV M5.05 A3.5x11 9407		
<b>S25S SVQBR/L-16S</b>	<b>25</b>	<b>23</b>	<b>250</b>	<b>19.5</b>	<b>≥32</b>					
S32T SVQBR/L-16	32	30	300	24	≥40					
S40U SVQBR/L-16	40	37	350	30	≥50					

## S SİSTEM DELİK TORNA KATERLERİ S System Boring Bars

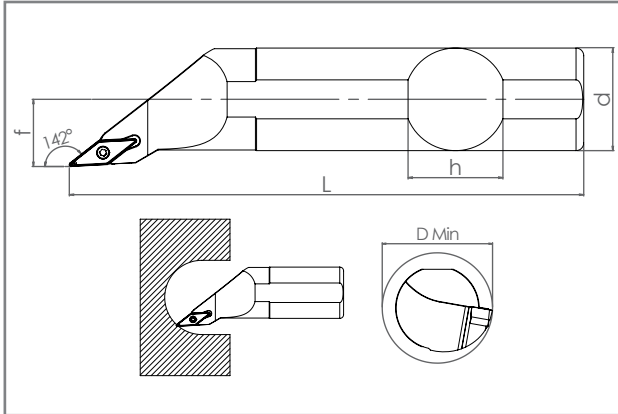



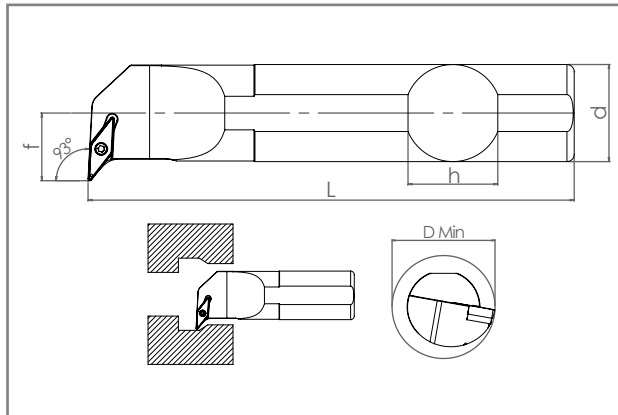

KOD CODE	ÖLÇÜLER DIMENSION (mm)					KESİCİ UÇ INSERT	YEDEK PARÇALAR SPARE PARTS				
	d	h	L	f	D min		Sıkma Vidası Clamp Screw	Altık Shim	Altık Vidası Shim Screw	Anahtar Torx Key	
SVJBR/L											
S25S SVJBR/L-16	25	23	250	19.5	≥32	VBM.1604..	SSV M3.5x10 9511	-	-	-	T15
<b>S25S SVJBR/L-16S</b>	<b>25</b>	<b>23</b>	<b>250</b>	<b>19.5</b>	<b>≥32</b>						
S32T SVJBR/L-16	32	30	300	24	≥40		SSV M3.5x14 9512	BAX VB16 9618	SBV2 M5.05 A3.5x9 9408	SBV M5.05 A3.5x11 9407	
S40U SVJBR/L-16	40	37	350	30	≥50						



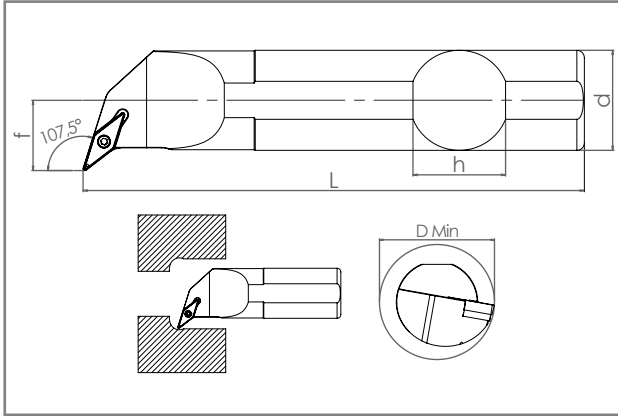



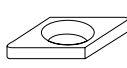

KOD CODE	ÖLÇÜLER DIMENSION (mm)					KESİCİ UÇ INSERT	YEDEK PARÇALAR SPARE PARTS				
	d	h	L	f	D min		Sıkma Vidası Clamp Screw	Altık Shim	Altık Vidası Shim Screw	Anahtar Torx Key	
SVUCR/L											
S16P SVUCR/L-11	16	15	170	13	≥21	VCM.1103..	SSV M2.5x5 9504	-	-	-	T15
S20R SVUCR/L-11	20	18	200	15	≥25						
S25S SVUCR/L-16	25	23	250	19.5	≥32	VCM.1604..	SSV M3.5x10 9511	BAX VC16 9620	SBV2 M5.05 A3.5x9 9408	SBV M5.05 A3.5x11 9407	
<b>S25S SVUCR/L-16S</b>	<b>25</b>	<b>23</b>	<b>250</b>	<b>19.5</b>	<b>≥32</b>						
S32T SVUCR/L-16	32	30	300	24	≥40		SSV M3.5x14 9512	BAX VC16 9620	SBV2 M5.05 A3.5x9 9408	SBV M5.05 A3.5x11 9407	
S40U SVUCR/L-16	40	37	350	30	≥50						

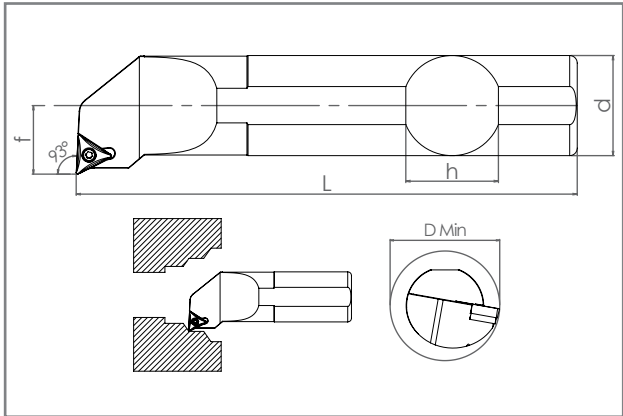
## S SİSTEM DELİK TORNA KATERLERİ S System Boring Bars



KOD CODE	ÖLÇÜLER DIMENSION (mm)					KESİCİ UÇ INSERT	YEDEK PARÇALAR SPARE PARTS			
	d	h	L	f	D min		Sıkma Vidası Clamp Screw	Altık Shim	Altık Vidası Shim Screw	Anahtar Torx Key
<b>SVQCR/L</b>										
S16P SVQCR/L-11	16	15	170	13	≥21	VCM.1103..	SSV M2.5x5 9504	-	-	T08
S20R SVQCR/L-11	20	18	200	15	≥25					
S25S SVQCR/L-16	25	23	250	19.5	≥32					
<b>S25S SVQCR/L-16S</b>	<b>25</b>	<b>23</b>	<b>250</b>	<b>19.5</b>	<b>≥32</b>	VCM.1604..	SSV M3.5x10 9511	BAX VC16 9620	SBV2 M5.05 A3.5x9 9408 SBV M5.05 A3.5x11 9407	T15
S32T SVQCR/L-16	32	30	300	24	≥40					
S40U SVQCR/L-16	40	37	350	30	≥50					



KOD CODE	ÖLÇÜLER DIMENSION (mm)					KESİCİ UÇ INSERT	YEDEK PARÇALAR SPARE PARTS			
	d	h	L	f	D min		Sıkma Vidası Clamp Screw	Altık Shim	Altık Vidası Shim Screw	Anahtar Torx Key
<b>STUCR/L</b>										
S10K STUCR/L-09	10	09	125	08	≥13	TCM.0902..	SSV M2.2x5 9503	-	-	T07
S12K STUCR/L-09	12	11	125	10	≥16					
S10K STUCR/L-11	10	09	125	08	≥13	TCM.1102..	SSV M2.5x5 9504	-	-	T08
S12K STUCR/L-11	12	11	125	10	≥16					
S16P STUCR/L-11	16	15	170	13	≥21					
S20R STUCR/L-11	20	18	200	15	≥25	TCM.16T3.	SSV M3.5x10 9511	BAX TC16 9619	SBV2 M5.05 A3.5x9 9408 SBV M5.05 A3.5x11 9407	T15
S16P STUCR/L-16	16	15	170	13	≥21					
S20R STUCR/L-16	20	18	200	15	≥25					
S25S STUCR/L-16	25	23	250	19.5	≥32					
<b>S25S STUCR/L-16S</b>	<b>25</b>	<b>23</b>	<b>250</b>	<b>19.5</b>	<b>≥32</b>					
S32T STUCR/L-16	32	30	300	24	≥40					
S40U STUCR/L-16	40	37	350	30	≥50					

## S SİSTEM DELİK TORNA KATERLERİ S System Boring Bars

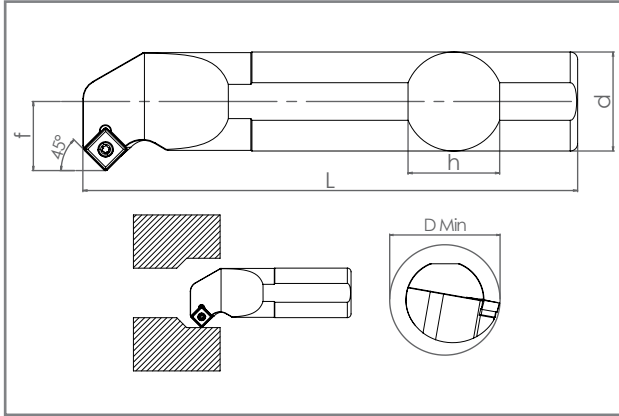

KOD CODE	ÖLÇÜLER DIMENSION (mm)					KESİCİ UÇ INSERT	YEDEK PARÇALAR SPARE PARTS			
	d	h	L	f	D <sub>min</sub>		Sıkma Vidası Clamp Screw	Altık Shim	Altık Vidası Shim Screw	Anahtar Torx Key
<b>SSSCR/L</b>										
S16P SSSCR/L-09	16	15	170	13	≥21	SCM. 09T3..	<b>SSV</b> M3.5x10 <b>9511</b>	-	-	T15
S20R SSSCR/L-09	20	18	200	15	≥25					
S25S SSSCR/L-09	25	23	250	19.5	≥32					
S25S SSSCR/L-12	25	23	250	19.5	≥32	SCM. 1204..	<b>SSV</b> M4x12x6 <b>9517</b>	-	-	T20
S32T SSSCR/L-12	32	30	300	22	≥40					
S40U SSSCR/L-12	40	37	350	27	≥50					

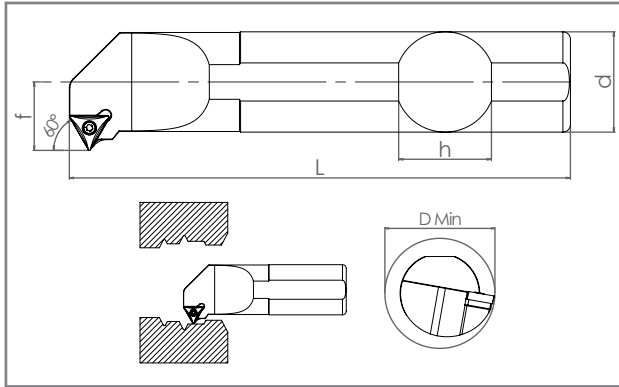





KOD CODE	ÖLÇÜLER DIMENSION (mm)					KESİCİ UÇ INSERT	YEDEK PARÇALAR SPARE PARTS			
	d	h	L	f	D <sub>min</sub>		Sıkma Vidası Clamp Screw	Altık Shim	Altık Vidası Shim Screw	Anahtar Torx Key
<b>ST-CR/L</b>										
S12K ST-CR/L-09	12	11	125	11	≥17	TCM.0902..	<b>SSV</b> M2.2x5 <b>9503</b>	-	-	T07
S12K ST-CR/L-11	12	11	125	11	≥17	TCM.1102..				<b>SSV</b> M2.5x5 <b>9504</b>
S16P ST-CR/L-11	16	15	170	13	≥21					
S20R ST-CR/L-11	20	18	200	15	≥25					
S16P ST-CR/L-16	16	15	170	13	≥21	TCM.16T3..	<b>SSV</b> M3.5x10 <b>9511</b>	-	-	T15
S20R ST-CR/L-16	20	18	200	15	≥25					
S25S ST-CR/L-16	25	23	250	19.5	≥32					
S32T ST-CR/L-16	32	30	300	24	≥40					
S40U ST-CR/L-16	40	37	350	30	≥50					
							<b>SSV</b> M3.5x14 <b>9512</b>	<b>BAX</b> TC16 <b>9619</b>	<b>SBV</b> M5.05 A3.5x11 <b>9407</b>	

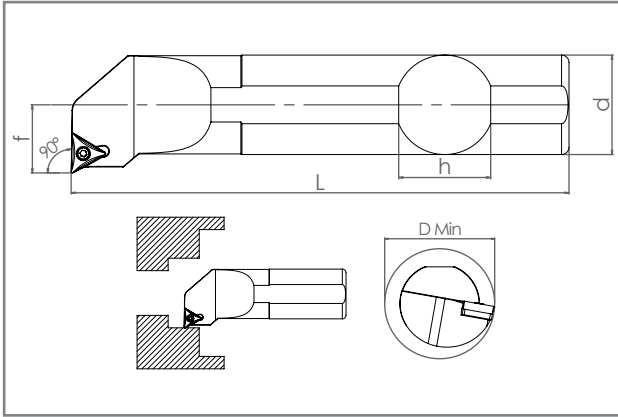



## S SİSTEM DELİK TORNA KATERLERİ

### S System Boring Bars

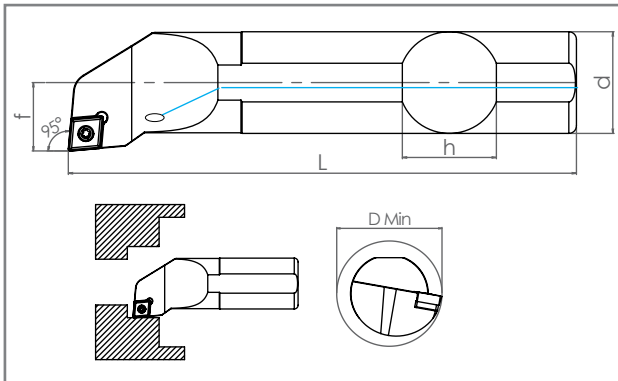

KOD CODE	ÖLÇÜLER DIMENSION (mm)					KESİCİ UÇ INSERT	YEDEK PARÇALAR SPARE PARTS			
	d	h	L	f	D min		Sıkma Vidası Clamp Screw	Altık Shim	Altık Vidası Shim Screw	Anahtar Torx Key
<b>STFCR/L</b>										
S0610F STFCR/L-06	10	09	125	05	≥08	TCM.06T1	SSV M2x4-9521			T06
S10K STFCR/L-09	10	09	125	08	≥13	TCM.0902..	SSV M2.2x5 9503			T07
S12K STFCR/L-09	12	11	125	10	≥17					
S10K STFCR/L-11	10	09	125	08	≥13	TCM.1102..	SSV M2.5x5 9504	-	-	T08
S12K STFCR/L-11	12	11	125	10	≥17					
S16P STFCR/L-11	16	15	170	13	≥21					
S20R STFCR/L-11	20	18	200	15	≥25	TCM.16T3..	SSV M3.5x10 9511			T15
S16P STFCR/L-16	16	15	170	13	≥21					
S20R STFCR/L-16	20	18	200	15	≥25					
S25S STFCR/L-16	25	23	250	19.5	≥32					
<b>S25S STFCR/L-16S</b>	<b>25</b>	<b>23</b>	<b>250</b>	<b>19.5</b>	<b>≥32</b>					
S32T STFCR/L-16	32	30	300	24	≥40		SSV M3.5x14 9512	BAX TC16 9619	SBV2 M5.05 A3.5x9 9408 SBV M5.05 A3.5x11 9407	
S40U STFCR/L-16	40	37	350	30	≥50					



KOD CODE	ÖLÇÜLER DIMENSION (mm)					KESİCİ UÇ INSERT	YEDEK PARÇALAR SPARE PARTS			
	d	h	L	f	D min		Sıkma Vidası Clamp Screw	Altık Shim	Altık Vidası Shim Screw	Anahtar Torx Key
<b>A-SCLCR/L</b>										
A08H SCLCR/L-06	08	07	100	07	≥11	CCM.0602..	SSV M2.5x6 9505			T08
A10H SCLCR/L-06	10	09	100	08	≥13					
A12H SCLCR/L-06	12	11	100	10	≥16	CCM.09T3..	SSV M3.5x10 9511	-	-	T15
A16M SCLCR/L-09	16	15	150	13	≥21					
A20P SCLCR/L-09	20	19	170	15	≥25					
A25R SCLCR/L-09	25	23	200	19.5	≥32					
A32S SCLCR/L-09	32	30	250	24	≥40		SSV M3.5x14 9512	BAX CC09 9616	SBV M5.05 A3.5x11 9407	

## S SİSTEM DELİK TORNA KATERLERİ

### S System Boring Bars

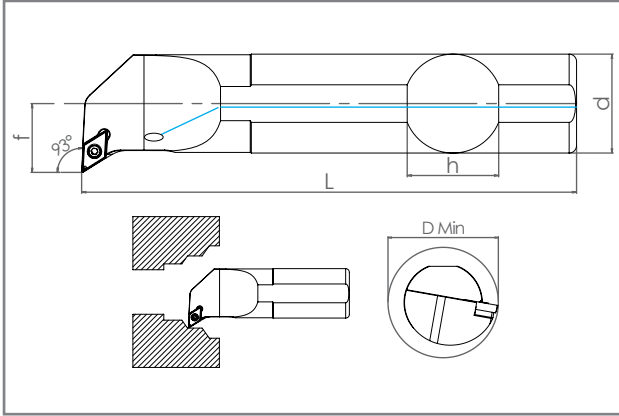

KOD CODE	ÖLÇÜLER DIMENSION (mm)					KESİCİ UÇ INSERT	YEDEK PARÇALAR SPARE PARTS			
	d	h	L	f	D min		Sıkma Vidası Clamp Screw	Altlık Shim	Altlık Vidası Shim Screw	Anahtar Torx Key
<b>A-SDUCR/L</b>										
A10H SDUCR/L-07	10	09	100	08	≥13	DCM. 0702..	SSV M2.5x6 9505	-	-	T08
A12H SDUCR/L-07	12	11	100	10	≥16					
A16M SDUCR/L-07	16	15	150	13	≥21					
A16M SDUCR/L-11	16	15	150	13	≥21	DCM. 11T3..	SSV M3.5x10 9511	-	-	T15
A20P SDUCR/L-11	20	18	170	15	≥25					
A25R SDUCR/L-11	25	23	200	19.5	≥32					
A32S SDUCR/L-11	32	30	250	24	≥40					

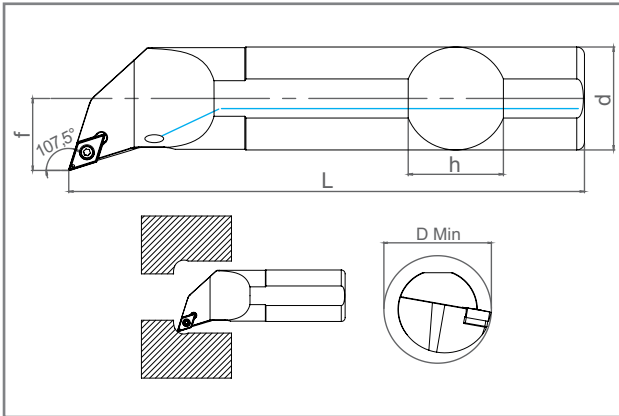

KOD CODE	ÖLÇÜLER DIMENSION (mm)					KESİCİ UÇ INSERT	YEDEK PARÇALAR SPARE PARTS			
	d	h	L	f	D min		Sıkma Vidası Clamp Screw	Altlık Shim	Altlık Vidası Shim Screw	Anahtar Torx Key
<b>A-SDQCR/L</b>										
A10H SDQCR/L-07	10	09	100	08	≥13	DCM. 0702..	SSV M2.5x6 9505	-	-	T08
A12H SDQCR/L-07	12	11	100	10	≥16					
A16M SDQCR/L-07	16	15	150	13	≥21					
A16M SDQCR/L-11	16	15	150	13	≥21	DCM. 11T3..	SSV M3.5x10 9511	-	-	T15
A20P SDQCR/L-11	20	18	170	15	≥25					
A25R SDQCR/L-11	25	23	200	19.5	≥32					
A32S SDQCR/L-11	32	30	250	24	≥40					

**Teknoloji profesyonellikle birleŖti**  
Technology combined with professionalism

[www.smoxh.com.tr](http://www.smoxh.com.tr)

## **DIŖ AP KANAL AMA TAKIMLARI**

External Grooving Toolholders



## DIŞ ÇAP KANAL AÇMA TAKIMLARI

### External Grooving Toolholders

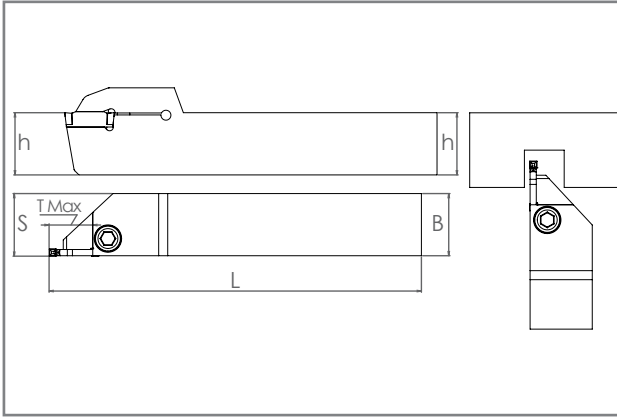





KOD CODE	ÖLÇÜLER DIMENSION (mm)					KESİCİ UÇ INSERT	YEDEK PARÇALAR SPARE PARTS		
	h	B	L	S	t max		Sıkma Vidası Clamp Screw	Pul Stamp	Anahtar Allen Key
<b>BDKT R/L KRLY-MGM</b>									
1212 BDKT R/L-K2C t max:15	12	12	100	12.3	15	<b>MGM 2C KRLY UCA UYGUNDUR FOR KRLY INSERT</b>	BKTV M5x17-9211		AA4
1616 BDKT R/L-K2C t max:18	16	16	125	16.3	18		BKTV M6x25 9215		AA5
2020 BDKT R/L-K2C t max:18	20	20	125	20.3	18		BKTV M8x30-9216		AA6
2020 BDKT R/L-K2C t max:12	20	20	125	20.3	12		BKTV M6x25 9215		AA5
2525 BDKT R/L-K2C t max:18	25	25	150	25.3	18		BKTV M6x25 9215		AA5
3232 BDKT R/L-K2C t max:18	32	32	170	32.3	18		BKTV M8x30-9216		AA6
<b>2020 BDKT R/L-K2.5C t max:18</b>	20	20	125	20.4	18	<b>MGM 2.5C KRLY UCA UYGUNDUR FOR KRLY INSERT</b>	BKTV M5x17-9211		AA4
<b>2525 BDKT R/L-K2.5C t max:18</b>	25	25	150	25.4	18		BKTV M6x25 9215		AA5
1212 BDKT R/L-K3C t max:18	12	12	100	12.3	18		BKTV M6x25 9215		AA5
1616 BDKT R/L-K3C t max:18	16	16	125	16.4	18		BKTV M8x30-9216		AA6
2020 BDKT R/L-K3C t max:20	20	20	125	20.4	20		BKTV M6x25 9215		AA5
2525 BDKT R/L-K3C t max:22	25	25	150	25.4	22		BKTV M8x30-9216		AA6
2525 BDKT R/L-K3C t max:25	25	25	150	25.4	25	<b>MGM 3C KRLY UCA UYGUNDUR FOR KRLY INSERT</b>	-		AA4
2525 BDKT R/L-K3C t max:40	25	25	150	25.4	40		BKTV M6x25 9215		AA5
3232 BDKT R/L-K3C t max:22	32	32	170	32.4	22		BKTV M8x30-9216		AA6
2020 BDKT R/L-K4C t max:20	20	20	125	20.4	20		BKTV M6x25 9215		AA5
2020 BDKT R/L-K4C t max:25	20	20	125	20.4	25		BKTV M8x30-9216		AA6
2525 BDKT R/L-K4C t max:22	25	25	150	25.4	22		BKTV M6x25 9215		AA5
2525 BDKT R/L-K4C t max:25	25	25	150	25.4	25	<b>MGM 4C KRLY UCA UYGUNDUR FOR KRLY INSERT</b>	BKTV M8x30-9216		AA6
2525 BDKT R/L-K4C t max:40	25	25	150	25.4	40		BKTV M6x25 9215		AA5
3232 BDKT R/L-K4C t max:22	32	32	170	32.4	22		BKTV M8x30-9216		AA6
2020 BDKT R/L-K5C t max:20	20	20	125	20.5	20		BKTV M6x25 9215		AA5
2525 BDKT R/L-K5C t max:25	25	25	150	25.5	25		BKTV M8x30-9216		AA6
2525 BDKT R/L-K5C t max:40	25	25	150	25.5	40		BKTV M6x25 9215		AA5
3232 BDKT R/L-K5C t max:25	32	32	170	32.5	25	<b>MGM 5C KRLY UCA UYGUNDUR FOR KRLY INSERT</b>	BKTV M8x30-9216		AA6
2525 BDKT R/L-K6C t max:25	25	25	150	25.6	25		BKTV M6x25-9215		AA5
3232 BDKT R/L-K6C t max:25	32	32	170	32.6	25		BKTV M8x30-9216		AA6
2525 BDKT R/L-K8C t max:25	25	25	150	25.6	25		BKTV M6x25-9215		AA5
3232 BDKT R/L-K8C t max:27	32	32	170	32.8	27		BKTV M8x30-9216		AA6
							<b>MGM 6C KRLY UCA UYGUNDUR FOR KRLY INSERT</b>		BKTV M6x25-9215
						<b>MGM 8C KRLY UCA UYGUNDUR FOR KRLY INSERT</b>	BKTV M6x25-9215		AA5
							BKTV M8x30-9216		AA6

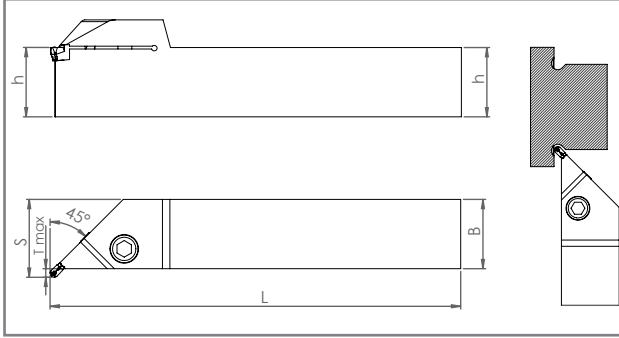

## DIŞ ÇAP KANAL AÇMA TAKIMLARI External Grooving Toolholders



KOD CODE	ÖLÇÜLER DIMENSION (mm)					KESİCİ UÇ INSERT	YEDEK PARÇALAR SPARE PARTS		
	h	B	L	S	t max		Sıkma Vidası Clamp Screw	Pul Stamp	Anahtar Allen Key
<b>BDRT R/L KRLY-MRMN</b>									
2020 BDRT R/L-KR3C t max:2.8	20	20	125	23	2.8	MR.. 3C KRLY UCA UYGUNDUR FOR KRLY INSERT	<b>BKTV M6x25 9215</b>	-	AA5
2525 BDRT R/L-KR3C t max:2.8	25	25	150	28	2.8				
3232 BDRT R/L-KR3C t max:2.8	32	32	170	32.4	2.8				
2020 BDRT R/L-KR4C t max:2.8	20	20	125	23	2.8	MR.. 4C KRLY UCA UYGUNDUR FOR KRLY INSERT	<b>BKTV M6x25 9215</b>	-	AA5
2525 BDRT R/L-KR4C t max:2.8	25	25	150	28	2.8				
3232 BDRT R/L-KR4C t max:2.8	32	32	170	32.4	2.8				
2525 BDRT R/L-KR5C t max:2.8	25	25	150	28	2.8	MR.. 5C KRLY UCA UYGUNDUR FOR KRLY INSERT	<b>BKTV M6x25 9215</b>	-	AA5
3232 BDRT R/L-KR5C t max:2.8	32	32	170	32.4	2.8				
3232 BDRT R/L-KR6C t max:2.8	32	32	170	32.4	2.8	MR.. 6C KRLY UCA UYGUNDUR FOR KRLY INSERT	<b>BKTV M6x25 9215</b>	-	AA5

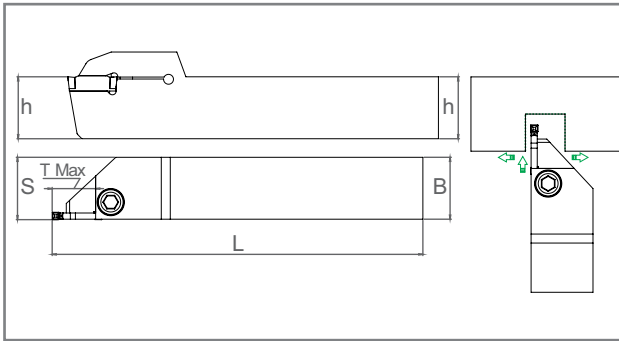

KOD CODE	ÖLÇÜLER DIMENSION (mm)					KESİCİ UÇ INSERT	YEDEK PARÇALAR SPARE PARTS		
	h	B	L	S	t max		Sıkma Vidası Clamp Screw	Pul Stamp	Anahtar Allen Key
<b>BDKT R/L KRLY-KGM</b>									
1212 BDKT R/L-KG2C t max:15	12	12	100	12.3	15	KGM 2C KRLY UCA UYGUNDUR FOR KRLY INSERT	<b>BKTV M5x17-9211</b>	-	AA4
1616 BDKT R/L-KG2C t max:18	16	16	100	16.3	18				
2020 BDKT R/L-KG2C t max:18	20	20	125	20.2	18				
2525 BDKT R/L-KG2C t max:18	25	25	150	25.2	18				
2020 BDKT R/L-KG3C t max:20	20	20	125	20.2	20	KGM 3C KRLY UCA UYGUNDUR FOR KRLY INSERT	<b>BKTV M6x25 9215</b>	-	AA5
2525 BDKT R/L-KG3C t max:22	25	25	150	25.2	22				
2020 BDKT R/L-KG4C t max:20	20	20	125	20.2	20	KGM 4C KRLY UCA UYGUNDUR FOR KRLY INSERT	<b>BKTV M6x25 9215</b>	-	AA5
2525 BDKT R/L-KG4C t max:22	25	25	150	25.2	22				
2525 BDKT R/L-KG5C t max:25	25	25	150	25.2	25	KGM 5C KRLY UCA UYGUNDUR FOR KRLY INSERT	<b>BKTV M6x25 9215</b>	-	AA5
2525 BDKT R/L-KG6C t max:25	25	25	150	25.2	25	KGM 6C KRLY UCA UYGUNDUR FOR KRLY INSERT	<b>BKTV M6x25 9215</b>	-	AA5

## DIŞ ÇAP KANAL AÇMA TAKIMLARI

### External Grooving Toolholders

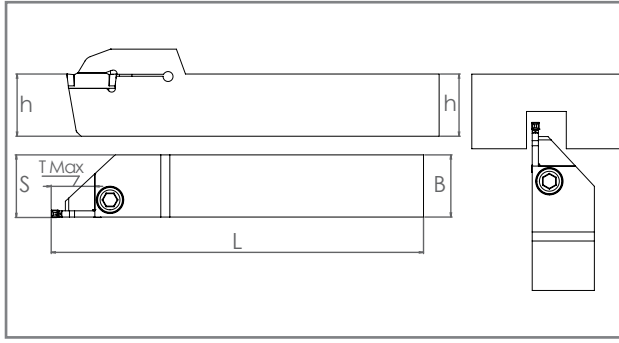



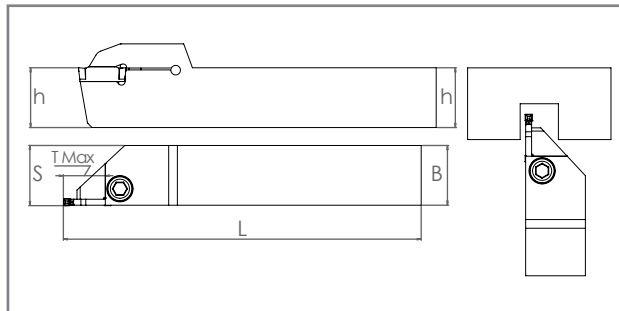

KOD CODE	ÖLÇÜLER DIMENSION (mm)					KESİCİ UÇ INSERT	YEDEK PARÇALAR SPARE PARTS		
	h	B	L	S	t max		Sıkma Vidası Clamp Screw	Pul Stamp	Anahtar Allen Key
<b>BDKT R/L ISCR DGN / GRIP / GIM</b>									
1212 BDKT R/L-ID2C t max:15	12	12	100	12.3	15	DGN 2C ISCR UCA UYGUNDUR FOR ISCR INSERT	BKTV M5x17-9211		AA4
1616 BDKT R/L-ID2C t max:18	16	16	100	16.3	18		BKTV M6x25 9215		AA5
2020 BDKT R/L-ID2C t max:18	20	20	125	20.3	18				
2525 BDKT R/L-ID2C t max:18	25	25	150	25.3	18	DGN 2.2C ISCR UCA UYGUNDUR FOR ISCR INSERT	BKTV M5x17-9211		AA4
<b>2020 BDKT R/L-ID2.2C t max:18</b>	20	20	125	20.3	18		BKTV M6x25 9215		AA5
<b>2525 BDKT R/L-ID2.2C t max:18</b>	25	25	150	25.3	18				
1212 BDKT R/L-ID3C t max:15	12	12	100	12.3	15	DGN 3C ISCR UCA UYGUNDUR FOR ISCR INSERT	BKTV M5x17-9211		AA4
1616 BDKT R/L-ID3C t max:18	16	16	100	16.4	18		BKTV M6x25 9215		AA5
2020 BDKT R/L-ID3C t max:20	20	20	125	20.4	20		BKTV M8x30-9216		AA6
2525 BDKT R/L-ID3C t max:22	25	25	150	25.3	22		BKTV M5x17-9211		AA4
3232 BDKT R/L-ID3C t max:22	32	32	170	32.4	22	GRIP 3C ISCR UCA UYGUNDUR FOR ISCR INSERT	BKTV M5x17-9211		AA4
<b>1212 BDKT R/L-IG3C t max:15</b>	12	12	100	12.3	15		BKTV M6x25 9215		AA5
<b>1616 BDKT R/L-IG3C t max:18</b>	16	16	100	16.4	18				
<b>2020 BDKT R/L-IG3C t max:20</b>	20	20	125	20.4	20		BKTV M8x30-9216		AA6
<b>2525 BDKT R/L-IG3C t max:22</b>	25	25	150	25.3	22				
<b>3232 BDKT R/L-IG3C t max:22</b>	32	32	170	32.4	22	GRIP 4C ISCR UCA UYGUNDUR FOR ISCR GRIP 4C INSERT	BKTV M6x25 9215		AA5
2020 BDKT R/L-IG4C t max:20	20	20	125	20.3	20		BKTV M8x30-9216		AA6
2525 BDKT R/L-IG4C t max:22	25	25	150	25.4	22	ISCR GRIP 5C	BKTV M6x25 9215		AA5
3232 BDKT R/L-IG4C t max:22	32	32	170	32.6	22				
3232 BDKT R/L-IG5C t max:25	32	32	170	32.8	25	GIM 3C ISCR UCA UYGUNDUR FOR ISCR GIM4C INSERT	BKTV M8x30-9216		AA6
1616 BDKT R/L-IGM3C t max:15	16	16	100	16.3	15		BKTV M6x25 9215		AA4
2020 BDKT R/L-IGM3C t max:20	20	20	125	20.3	20				
2525 BDKT R/L-IGM3C t max:22	25	25	150	25.3	22			AA5	



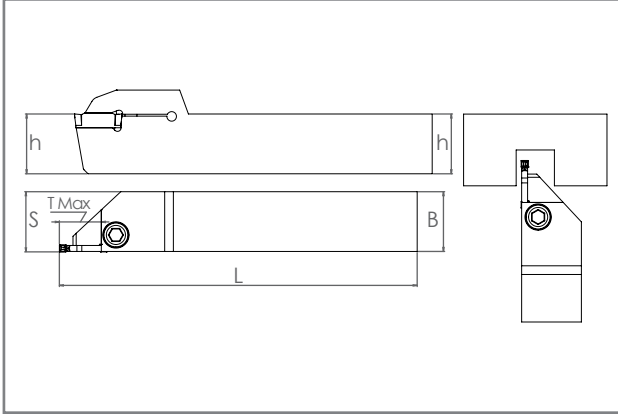



KOD CODE	ÖLÇÜLER DIMENSION (mm)					KESİCİ UÇ INSERT	YEDEK PARÇALAR SPARE PARTS		
	h	B	L	S	t max		Sıkma Vidası Clamp Screw	Pul Stamp	Anahtar Allen Key
<b>BDKT R/L KYC GDM</b>									
2020 BDKT R/L KYC2C-T18	20	20	125	20.2	18	GDM 2020 KYCR UCA UYGUNDUR FOR KYCR INSERT	BKTV M6x25 9215		AA5
2525 BDKT R/L KYC2C-T18	25	25	150	25.2	18				
2020 BDKT R/L KYC3C-T20	20	20	125	20.3	20				
2525 BDKT R/L KYC3C-T22	25	25	150	25.3	22				
2020 BDKT R/L KYC4C-T20	20	20	125	20.4	20				
2525 BDKT R/L KYC4C-T22	25	25	150	25.4	22				

## DIŞ ÇAP KANAL AÇMA TAKIMLARI External Grooving Toolholders

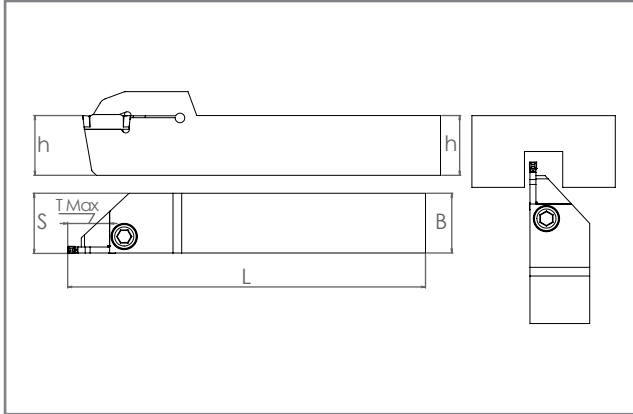

KOD CODE	ÖLÇÜLER DIMENSION (mm)					KESİCİ UÇ INSERT	YEDEK PARÇALAR SPARE PARTS		
	h	B	L	S	t max		Sıkma Vidası Clamp Screw	Pul Stamp	Anahtar Allen Key
<b>BDKT R/L WLTR / CRTZT ..GX16 / ..GX24</b>									
2020 BDKT R/L 2GX16 t max:18	20	20	125	20.2	18	2GX16 WLTR/CRTZT UCA UYGUNDUR FOR WLTR/CRTZT INSERT	BKTV M6x25 9215	-	AA5
2525 BDKT R/L 2GX16 t max:18	25	25	150	25.2	18				
2020 BDKT R/L 3GX16 t max:20	20	20	125	20.2	20	3GX16 WLTR/CRTZT UCA UYGUNDUR FOR WLTR/CRTZT INSERT			
2525 BDKT R/L 3GX16 t max:22	25	25	150	25.2	22				
2020 BDKT R/L 2GX24 t max:18	20	20	125	20.3	18	2GX24 WLTR/CRTZT UCA UYGUNDUR FOR WLTR/CRTZT INSERT			
2525 BDKT R/L 2GX24 t max:18	25	25	150	25.3	18				
2020 BDKT R/L 3GX24 t max:20	20	20	125	20.3	20	3GX24 WLTR/CRTZT UCA UYGUNDUR FOR WLTR/CRTZT INSERT			
2525 BDKT R/L 3GX24 t max:22	25	25	150	25.3	22				
2525 BDKT R/L 4GX24 t max:22	25	25	150	25.5	22	4GX24 WLTR/CRTZT UCA UYGUNDUR FOR WLTR/CRTZT INSERT			



KOD CODE	ÖLÇÜLER DIMENSION (mm)					KESİCİ UÇ INSERT	YEDEK PARÇALAR SPARE PARTS		
	h	B	L	S	t max		Sıkma Vidası Clamp Screw	Pul Stamp	Anahtar Allen Key
<b>BDKT R/L-LAMINA (GCTX)</b>									
1616 BDKT R/L-GC-LM-2C t max:18	16	16	125	16.2	18	GCTX-2 LAMINA UCA UYGUNDUR FOR LAMINA INSERT	BKTV M6x25 9215	-	AA5
2020 BDKT R/L-GC-LM-2C t max:18	20	20	125	20.2	18				
2525 BDKT R/L-GC-LM-2C t max:18	25	25	150	25.2	18	GCTX-3 LAMINA UCA UYGUNDUR FOR LAMINA INSERT			
1616 BDKT R/L-GC-LM-3C t max:18	16	16	125	16.3	18				
2020 BDKT R/L-GC-LM-3C t max:20	20	20	125	20.3	20	GCTX-3 LAMINA UCA UYGUNDUR FOR LAMINA INSERT			
2525 BDKT R/L-GC-LM-3C t max:22	25	25	150	25.3	22				

## DIŞ ÇAP KANAL AÇMA TAKIMLARI External Grooving Toolholders

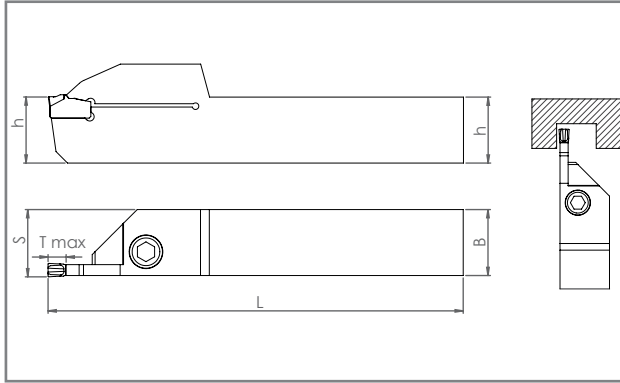



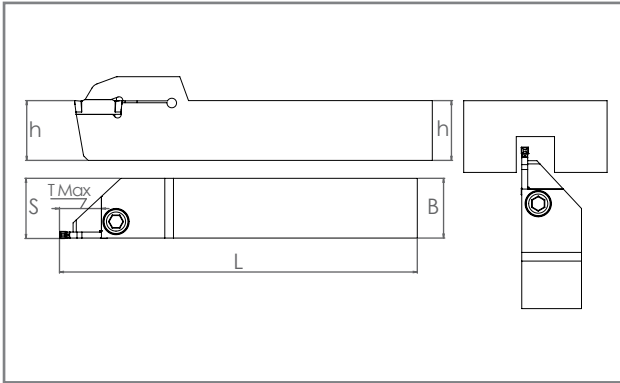

KOD CODE	ÖLÇÜLER DIMENSION (mm)					KESİCİ UÇ INSERT	YEDEK PARÇALAR SPARE PARTS		
	h	B	L	S	t max		Sıkma Vidası Clamp Screw	Pul Stamp	Anahtar Allen Key
<b>BDKT R/L SDV 151.2</b>									
1616 BDKT R/L SDV 151.2 2C t max:18	16	16	100	16.2	18	151.2-2C SDVK UCA UYGUNDUR FOR SDVK INSERT			
2020 BDKT R/L SDV 151.2 2C t max:18	20	20	125	20.2	18				
2525 BDKT R/L SDV 151.2 2C t max:18	25	25	150	25.2	18				
1616 BDKT R/L SDV 151.2 3C t max:18	16	16	100	16.3	18	151.2-3C SDVK UCA UYGUNDUR FOR SDVK INSERT	BKTV M6x25 9215	-	AA5
2020 BDKT R/L SDV 151.2 3C t max:20	20	20	125	20.3	20				
2525 BDKT R/L SDV 151.2 3C t max:22	25	25	150	25.3	22				
1616 BDKT R/L SDV 151.2 4C t max:18	16	16	100	16.4	18	151.2-4C SDVK UCA UYGUNDUR FOR SDVK INSERT	BKTV M6x25 9215	-	AA5
2020 BDKT R/L SDV 151.2 4C t max:20	20	20	125	20.4	20				
2525 BDKT R/L SDV 151.2 4C t max:22	25	25	150	25.4	22				
2020 BDKT R/L SDV 151.2 5C t max:20	20	20	125	20.5	20	151.2-5C SDVK UCA UYGUNDUR FOR SDVK INSERT	BKTV M6x25 9215	-	AA5
2525 BDKT R/L SDV 151.2 5C t max:25	25	25	150	25.5	25				



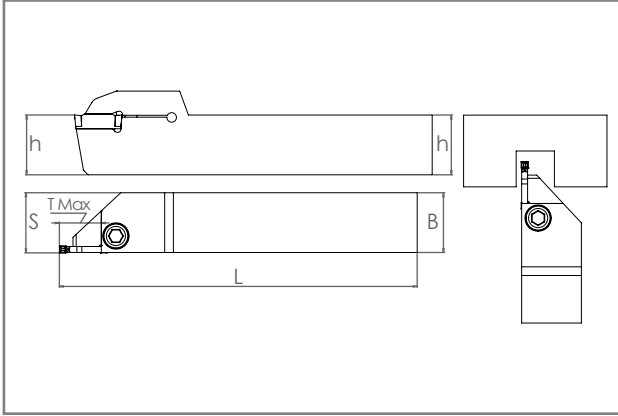



KOD CODE	ÖLÇÜLER DIMENSION (mm)					KESİCİ UÇ INSERT	YEDEK PARÇALAR SPARE PARTS		
	h	B	L	S	t max		Sıkma Vidası Clamp Screw	Pul Stamp	Anahtar Allen Key
<b>BDKT R/L SDV 123</b>									
1212 BDKT R/L-SDV123-2C t max:15	12	12	100	12.3	15	123-2C SDVK UCA UYGUNDUR FOR SDVK INSERT	BKTV M5x17-9211		
1616 BDKT R/L-SDV123-2C t max:18	16	16	100	16.3	18				
2020 BDKT R/L-SDV123-2C t max:18	20	20	125	20.3	18				
2525 BDKT R/L-SDV123-2C t max:18	25	25	150	25.3	18	123-3C SDVK UCA UYGUNDUR FOR SDVK INSERT	BKTV M5x17-9211	-	AA4
1212 BDKT R/L-SDV123-3C t max:15	12	12	100	12.3	15				
1616 BDKT R/L-SDV123-3C t max:18	16	16	100	16.4	18				
2020 BDKT R/L-SDV123-3C t max:20	20	20	125	20.4	20	123-4C SDVK UCA UYGUNDUR FOR SDVK INSERT	BKTV M6x25 9215	-	AA5
2525 BDKT R/L-SDV123-3C t max:22	25	25	150	25.4	22				
2020 BDKT R/L-SDV123-4C t max:20	20	20	125	20.4	20				
2525 BDKT R/L-SDV123-4C t max:22	25	25	150	25.4	22	123-5C SDVK UCA UYGUNDUR FOR SDVK INSERT	BKTV M6x25 9215	-	AA5
2020 BDKT R/L-SDV123-5C t max:22	20	20	125	20.5	22				
2525 BDKT R/L-SDV123-5C t max:25	25	25	150	25.5	25				

## DIŞ ÇAP KANAL AÇMA TAKIMLARI External Grooving Toolholders

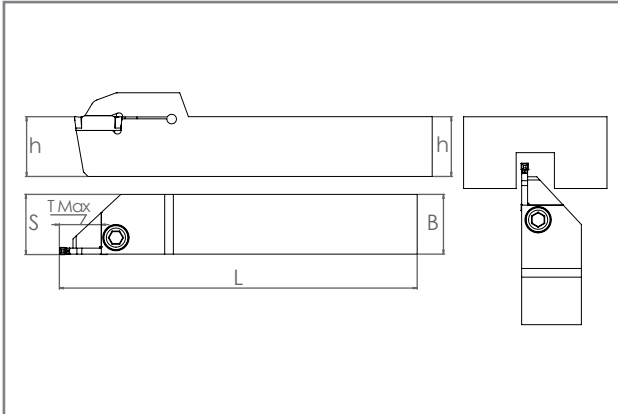

KOD CODE	ÖLÇÜLER DIMENSION (mm)					KESİCİ UÇ INSERT	YEDEK PARÇALAR SPARE PARTS		
	h	B	L	S	t max		Sıkma Vidası Clamp Screw	Pul Stamp	Anahtar Allen Key
<b>BDKT R/L HORN S229</b>									
2020 BDKT R/L-H-S229-2C t max:18	20	20	125	20.5	18	S229.02 HORN UCA UYGUNDUR FOR HORN INSERT	BKTV M6x25 9215	-	AA5
2525 BDKT R/L-H-S229-2C t max:18	25	25	150	25.5	18				
2020 BDKT R/L-H-S229-3C t max:20	20	20	125	20.5	20	S229.03 HORN UCA UYGUNDUR FOR HORN INSERT	BKTV M6x25 9215	-	AA5
2525 BDKT R/L-H-S229-3C t max:22	25	25	150	25.5	22				
2020 BDKT R/L-H-S229-4C t max:20	20	20	125	20.5	20	S229.04 HORN UCA UYGUNDUR FOR HORN INSERT	BKTV M6x25 9215	-	AA5
2525 BDKT R/L-H-S229-4C t max:22	25	25	150	25.5	22				
2020 BDKT R/L-H-S229-5C t max:20	20	20	125	20.5	20	S229.05 HORN UCA UYGUNDUR FOR HORN INSERT	BKTV M6x25 9215	-	AA5
2525 BDKT R/L-H-S229-5C t max:25	25	25	150	25.5	25				



KOD CODE	ÖLÇÜLER DIMENSION (mm)					KESİCİ UÇ INSERT	YEDEK PARÇALAR SPARE PARTS		
	h	B	L	S	t max		Sıkma Vidası Clamp Screw	Pul Stamp	Anahtar Allen Key
<b>BDKT R/L-K.HORN S224</b>									
2020 BDKT R/L-HK-S224-2C t max:18	20	20	125	20.3	18	S224.02 HORN UCA UYGUNDUR FOR HORN INSERT	BKTV M6x25 9215	-	AA5
2525 BDKT R/L-HK-S224-2C t max:18	25	25	150	25.3	18				
2020 BDKT R/L-HK-S224-3C t max:20	20	20	125	20.4	20	S224.03 HORN UCA UYGUNDUR FOR HORN INSERT	BKTV M6x25 9215	-	AA5
2525 BDKT R/L-HK-S224-3C t max:22	25	25	150	25.4	22				
2020 BDKT R/L-HK-S224-4C t max:20	20	20	125	20.4	20	S224.04 HORN UCA UYGUNDUR FOR HORN INSERT	BKTV M6x25 9215	-	AA5
2525 BDKT R/L-HK-S224-4C t max:22	25	25	150	25.4	22				

## DIŞ ÇAP KANAL AÇMA TAKIMLARI External Grooving Toolholders

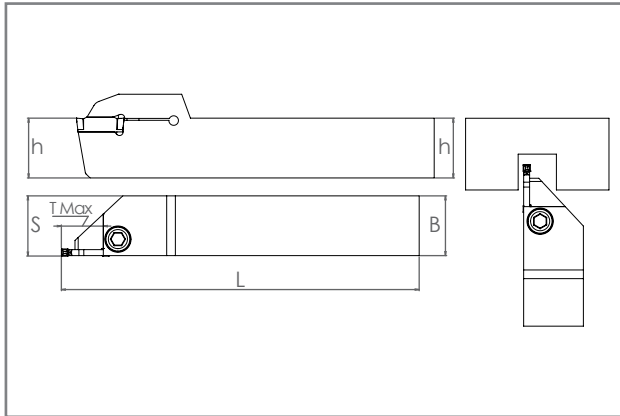



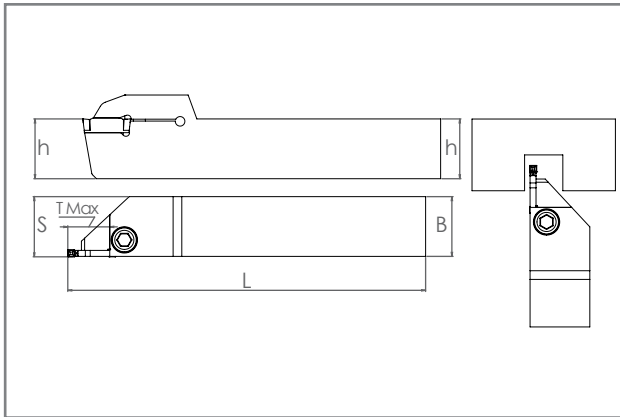



KOD CODE	ÖLÇÜLER DIMENSION (mm)					KESİCİ UÇ INSERT	YEDEK PARÇALAR SPARE PARTS		
	h	B	L	S	t max		Sıkma Vidası Clamp Screw	Pul Stamp	Anahtar Allen Key
<b>BDKT R/L TGTC TDC</b>									
1212 BDKT R/L-T-2C t max:15	12	12	100	12.3	15	TDC-2C TGTC UCA UYGUNDUR FOR TGTC INSERT	BKTV M5x17-9211		AA4
1616 BDKT R/L-T-2C t max:18	16	16	100	16.3	18		BKTV M6x25 9215		AA5
2020 BDKT R/L-T-2C t max:18	20	20	125	20.3	18		BKTV M5x17-9211		AA4
1212 BDKT R/L-T-3C t max:15	12	12	100	12.3	15	TDC-3C TGTC UCA UYGUNDUR FOR TGTC INSERT	-	-	AA5
1616 BDKT R/L-T-3C t max:18	16	16	100	16.4	18				
2020 BDKT R/L-T-3C t max:20	20	20	125	20.4	20				
2525 BDKT R/L-T-3C t max:22	25	25	150	25.4	22	TDC-4C TGTC UCA UYGUNDUR FOR TGTC INSERT	BKTV M6x25 9215	-	AA5
2020 BDKT R/L-T-4C t max:20	20	20	125	20.4	20				
2525 BDKT R/L-T-4C t max:22	25	25	150	25.4	22				

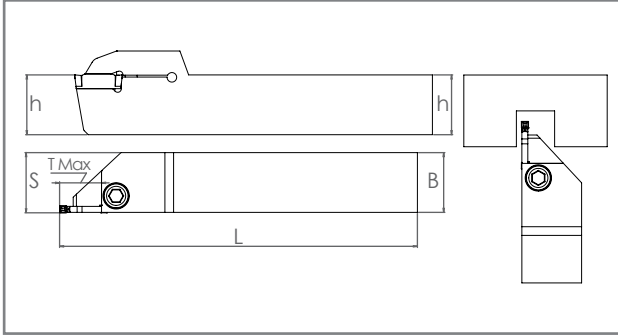





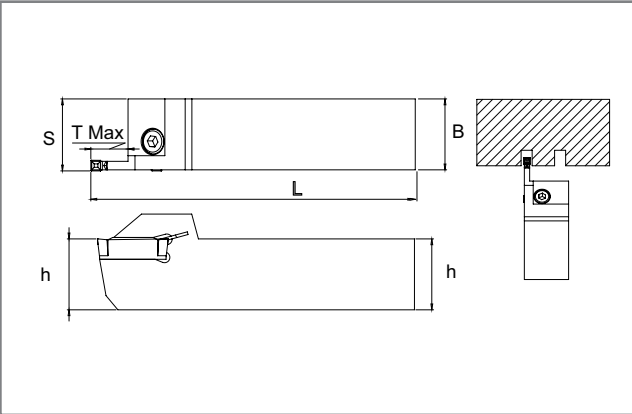

KOD CODE	ÖLÇÜLER DIMENSION (mm)					KESİCİ UÇ INSERT	YEDEK PARÇALAR SPARE PARTS		
	h	B	L	S	t max		Sıkma Vidası Clamp Screw	Pul Stamp	Anahtar Allen Key
<b>BDKT R/L ZCC-CT ZT..</b>									
1616 BDKT R/L-ZCC2-2C t max:18	16	16	100	16.3	18	ZTDB 2 ZCC-CT UCA UYGUNDUR FOR ZCC-CT INSERT	BKTV M6x25 9215	-	AA5
2020 BDKT R/L-ZCC2-2C t max:18	20	20	125	20.3	18				
2525 BDKT R/L-ZCC2-2C t max:18	25	25	150	25.3	18				
1616 BDKT R/L-ZCC2-3C t max:18	16	16	100	16.5	18	ZTFD 3 ZCC-CT UCA UYGUNDUR FOR ZCC-CT INSERT	-	-	AA5
2020 BDKT R/L-ZCC2-3C t max:20	20	20	125	20.3	20				
2525 BDKT R/L-ZCC2-3C t max:22	25	25	150	25.3	22				
2020 BDKT R/L-ZCC2-4C t max:20	20	20	125	20.5	20	ZTGD 4 ZCC-CT UCA UYGUNDUR FOR ZCC-CT INSERT	-	-	AA5
2525 BDKT R/L-ZCC2-4C t max:22	25	25	150	25.5	22				
2020 BDKT R/L-ZCC2-5C t max:22	20	20	125	20.5	22	ZTHD 5 ZCC-CT UCA UYGUNDUR FOR ZCC-CT INSERT	-	-	AA5
2525 BDKT R/L-ZCC2-5C t max:25	25	25	150	25.5	25				

## DIŞ ÇAP KANAL AÇMA TAKIMLARI External Grooving Toolholders



KOD CODE	ÖLÇÜLER DIMENSION (mm)					KESİCİ UÇ INSERT	YEDEK PARÇALAR SPARE PARTS		
	h	B	L	S	t max		Sıkma Vidası Clamp Screw	Pul Stamp	Anahtar Allen Key
<b>BDKT R/L SMTM (GCM)</b>									
1212 BDKT R/L-SM-GCM-2C t max:15	12	12	100	12.2	15	GCM-2C SMTM UCA UYGUNDUR FOR SMTM INSERT	BKTV M5x17-9211		AA4
1616 BDKT R/L-SM-GCM-2C t max:18	16	16	125	16.2	18		BKTV M6x25 9215		AA5
2020 BDKT R/L-SM-GCM-2C t max:18	20	20	125	20.2	18				
2525 BDKT R/L-SM-GCM-2C t max:18	25	25	150	25.2	18	GCM-3C SMTM UCA UYGUNDUR FOR SMTM INSERT	BKTV M5x17-9211		AA4
1212 BDKT R/L-SM-GCM-3C t max:15	12	12	100	12.2	15		BKTV M6x25 9215		AA5
1616 BDKT R/L-SM-GCM-3C t max:15	16	16	125	16.3	15				
2020 BDKT R/L-SM-GCM-3C t max:20	20	20	125	20.3	20				
2525 BDKT R/L-SM-GCM-3C t max:22	25	25	150	25.3	22				



KOD CODE	ÖLÇÜLER DIMENSION (mm)					KESİCİ UÇ INSERT	YEDEK PARÇALAR SPARE PARTS		
	h	B	L	S	t max		Sıkma Vidası Clamp Screw	Pul Stamp	Anahtar Allen Key
<b>BDKT R/L-K.O KRLY-MGMN</b>									
1010 BDKT R/L K2C K.O t max:10	10	10	120	10.20	10	MGMN 2C KRLY UCA UYGUNDUR FOR KRLY INSERT	SSV M3.5x14 9512		T15
1212 BDKT R/L K2C K.O t max:10	12	12	120	12.20	10		SSV M4x14-9516		
1616 BDKT R/L K2C K.O t max:16	16	16	120	16.20	16				
1010 BDKT R/L K3C K.O t max:10	10	10	120	10.20	10	MGMN 3C KRLY UCA UYGUNDUR FOR KRLY INSERT	SSV M3.5x14 9512		T15
1212 BDKT R/L K3C K.O t max:10	12	12	120	12.20	10		SSV M4x14-9516		
1616 BDKT R/L K3C K.O t max:16	16	16	120	16.20	16				

## KAYAR OTOMAT DIŞ ÇAP KANAL AÇMA TAKIMLARI

### Automatic Type External Grooving Toolholders

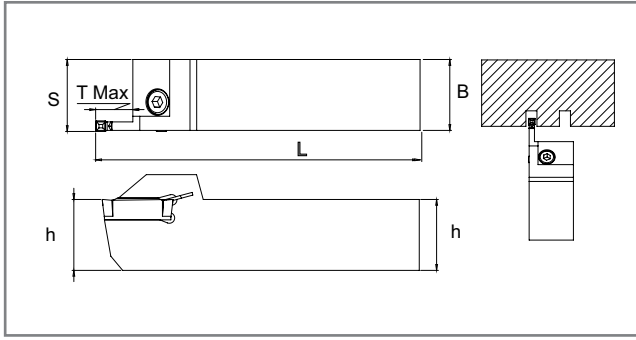

KOD CODE	ÖLÇÜLER DIMENSION (mm)					KESİCİ UÇ INSERT	YEDEK PARÇALAR SPARE PARTS		
	h	B	L	S	t max		Sıkma Vidası Clamp Screw	Pul Stamp	Anahtar Allen Key
<b>BDKT R/L-K.O KRLY-KGM</b>									
1010 BDKT R/L KGM2C K.O t max:10	10	10	120	10.20	10	KGM 2C KRLY UCA UYGUNDUR FOR KRLY INSERT	SSV M3.5x14 9512	-	T15
1212 BDKT R/L KGM2C K.O t max:10	12	12	120	12.20	10		SSV M4x14-9516		
1616 BDKT R/L KGM2C K.O t max:16	16	16	120	16.20	16				

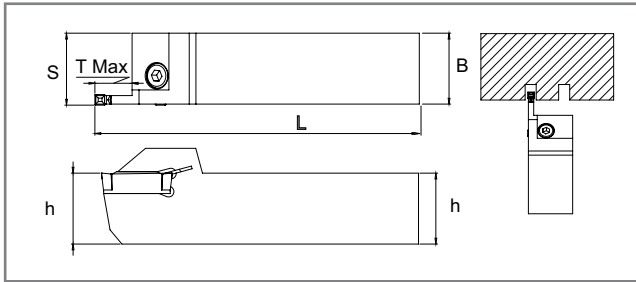

KOD CODE	ÖLÇÜLER DIMENSION (mm)					KESİCİ UÇ INSERT	YEDEK PARÇALAR SPARE PARTS		
	h	B	L	S	t max		Sıkma Vidası Clamp Screw	Pul Stamp	Anahtar Allen Key
<b>BDKT R/L-K.O TGTC-TDC</b>									
1010 BDKT R/L T2C K.O t max:10	10	10	120	10.20	10	TDC 2C TGTC UCA UYGUNDUR FOR TGTC INSERT	SSV M3.5x14 9512	-	T15
1212 BDKT R/L T2C K.O t max:10	12	12	120	12.20	10		SSV M4x14-9516		
1616 BDKT R/L T2C K.O t max:16	16	16	120	16.20	16				

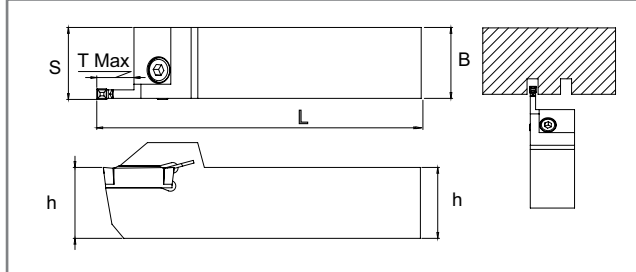







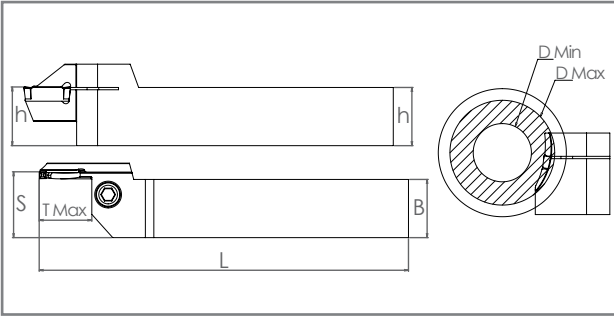





KOD CODE	ÖLÇÜLER DIMENSION (mm)					KESİCİ UÇ INSERT	YEDEK PARÇALAR SPARE PARTS		
	h	B	L	S	t max		Sıkma Vidası Clamp Screw	Pul Stamp	Anahtar Allen Key
<b>BDKT R/L-K.O ISCR-DGN</b>									
1212 BDKT R/L ID2C K.O t max:10	12	12	120	12.20	10	DGN 2C ISCR UCA UYGUNDUR FOR ISCR INSERT	SSV M3.5x14 9512	-	T15
1616 BDKT R/L ID2C K.O t max:16	16	16	120	16.20	16		SSV M4x14-9516		
1010 BDKT R/L ID3C K.O t max:10	10	10	120	10.20	10				
1212 BDKT R/L ID3C K.O t max:10	12	12	120	12.20	10	DGN 3C ISCR UCA UYGUNDUR FOR ISCR INSERT			
1616 BDKT R/L ID3C K.O t max:16	16	16	120	16.20	16				







## DIŞ ÇAP ALIN KANAL AÇMA TAKIMLARI Face External Grooving Toolholders

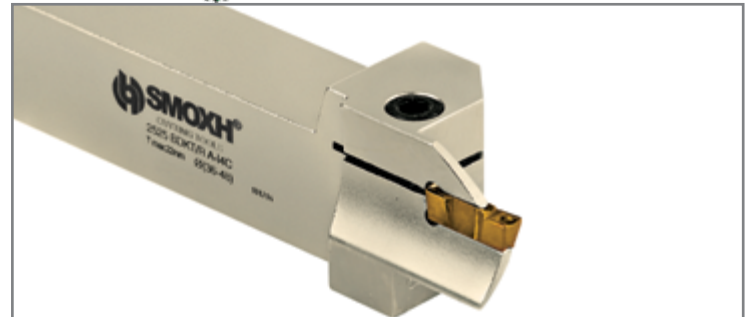
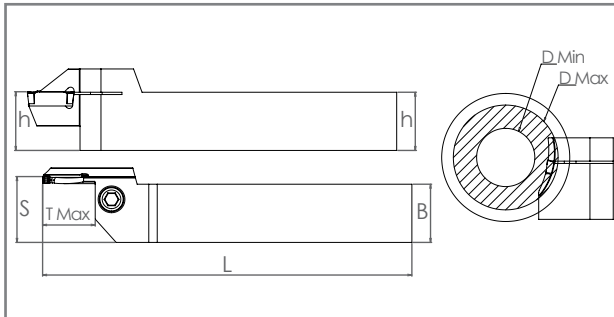

KOD CODE	ÖLÇÜLER DIMENSION (mm)							KESİCİ UÇ INSERT	YEDEK PARÇALAR SPARE PARTS			
	h	B	L	S	t max	øD min	øD max		Sıkma Vidası Clamp Screw	Pul Stamp	Anahtar Allen Key	
<b>BDKT A KRLY-MGM</b>												
2525 BDKT A K3C (Ø24x36) t max:17	25	25	150	26.5	17	24	36	MGM 3C KRLY UCA UYGUNDUR FOR KRLY INSERT				
2525 BDKT A K3C (Ø36x48) t max:17	25	25	150	26.5	17	36	48					
2525 BDKT A K3C (Ø48x70) t max:17	25	25	150	26.5	17	48	70					
2525 BDKT A K3C (Ø70x110) t max:17	25	25	150	26.5	17	70	110					
2525 BDKT A K3C (Ø100x150) t max:17	25	25	150	26.5	17	100	150					
2525 BDKT A K3C (Ø150x200) t max:17	25	25	150	26.5	17	150	200					
<b>2525 BDKT A K3C (Ø200x350) t max:17</b>	<b>25</b>	<b>25</b>	<b>150</b>	<b>26.5</b>	<b>17</b>	<b>200</b>	<b>350</b>					
<b>2525 BDKT A K3C (Ø300x500) t max:17</b>	<b>25</b>	<b>25</b>	<b>150</b>	<b>26.5</b>	<b>17</b>	<b>300</b>	<b>500</b>					
2525 BDKT A K4C (Ø24x36) t max:22	25	25	150	26.5	22	24	36	MGM 4C KRLY UCA UYGUNDUR FOR KRLY INSERT	BKT V M6x25 9215	-	AA5	
2525 BDKT A K4C (Ø36x48) t max:22	25	25	150	26.5	22	36	48					
2525 BDKT A K4C (Ø48x70) t max:22	25	25	150	26.5	22	48	70					
2525 BDKT A K4C (Ø70x110) t max:22	25	25	150	26.5	22	70	110					
2525 BDKT A K4C (Ø100x150) t max:22	25	25	150	26.5	22	100	150					
2525 BDKT A K4C (Ø150x200) t max:22	25	25	150	26.5	22	150	200					
<b>2525 BDKT A K4C (Ø200x350) t max:22</b>	<b>25</b>	<b>25</b>	<b>150</b>	<b>26.5</b>	<b>22</b>	<b>200</b>	<b>350</b>					
<b>2525 BDKT A K4C (Ø300x500) t max:22</b>	<b>25</b>	<b>25</b>	<b>150</b>	<b>26.5</b>	<b>22</b>	<b>300</b>	<b>500</b>					
2525 BDKT A K5C (Ø36x48) t max:25	25	25	150	26.5	25	36	48	MGM 5C KRLY UCA UYGUNDUR FOR KRLY INSERT	BKT V M6x25 9215	-	AA5	
2525 BDKT A K5C (Ø48x70) t max:25	25	25	150	26.5	25	48	70					
2525 BDKT A K5C (Ø70x110) t max:25	25	25	150	26.5	25	70	110					
2525 BDKT A K5C (Ø100x150) t max:25	25	25	150	26.5	25	100	150					
2525 BDKT A K5C (Ø150x200) t max:25	25	25	150	26.5	25	150	200					
<b>2525 BDKT A K5C (Ø200x350) t max:25</b>	<b>25</b>	<b>25</b>	<b>150</b>	<b>26.5</b>	<b>25</b>	<b>200</b>	<b>350</b>					
<b>2525 BDKT A K5C (Ø300x500) t max:25</b>	<b>25</b>	<b>25</b>	<b>150</b>	<b>26.5</b>	<b>25</b>	<b>300</b>	<b>500</b>					



KOD CODE	ÖLÇÜLER DIMENSION (mm)							KESİCİ UÇ INSERT	YEDEK PARÇALAR SPARE PARTS		
	h	B	L	S	t max	øD min	øD max		Sıkma Vidası Clamp Screw	Pul Stamp	Anahtar Allen Key
<b>BDKT A ISCR-GRIP</b>											
2525 BDKT A I4C (Ø24x36) t max:22	25	25	150	26.5	22	24	36	GRIP 4C ISCR UCA UYGUNDUR FOR ISCR INSERT	BKT V M6x25 9215	-	AA5
2525 BDKT A I4C (Ø36x48) t max:22	25	25	150	26.5	22	36	48				
2525 BDKT A I4C (Ø48x70) t max:22	25	25	150	26.5	22	48	70				
2525 BDKT A I4C (Ø70x110) t max:22	25	25	150	26.5	22	70	110				
2525 BDKT A I4C (Ø100x150) t max:22	25	25	150	26.5	22	100	150				
2525 BDKT A I4C (Ø150x200) t max:22	25	25	150	26.5	22	150	200				
<b>2525 BDKT A I4C (Ø200x350) t max:22</b>	<b>25</b>	<b>25</b>	<b>150</b>	<b>26.5</b>	<b>22</b>	<b>200</b>	<b>350</b>				
<b>2525 BDKT A I4C (Ø300x500) t max:22</b>	<b>25</b>	<b>25</b>	<b>150</b>	<b>26.5</b>	<b>22</b>	<b>300</b>	<b>500</b>				

## DIŞ ÇAP ALIN KANAL AÇMA TAKIMLARI

### Face External Grooving Toolholders

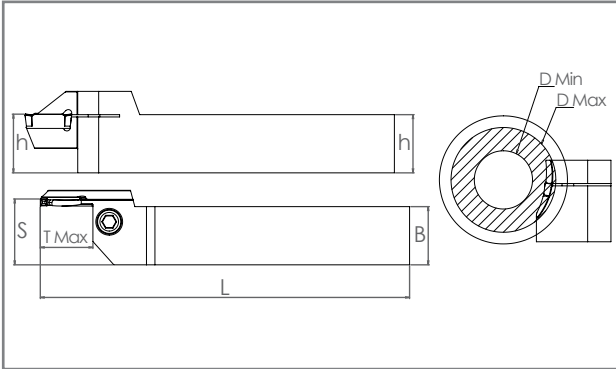



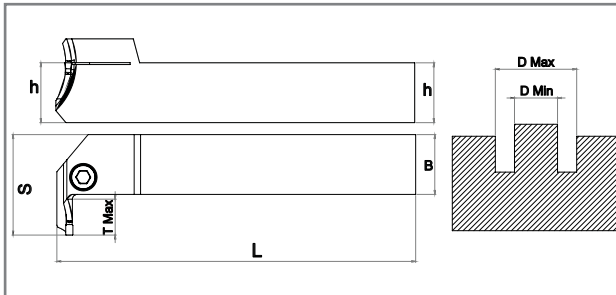

KOD CODE	ÖLÇÜLER DIMENSION (mm)							KESİCİ UÇ INSERT	YEDEK PARÇALAR SPARE PARTS						
	h	B	L	S	t max	øD min	øD max		Sıkma Vidası Clamp Screw	Pul Stamp	Anahtar Allen Key				
<b>BDKT A ZCC-CT ZT..</b>															
2525 BDKT A ZT 3C (Ø24x36) t max:17	25	25	150	26.5	17	24	36	ZTFD 3 ZCC-CT UCA UYGUNDUR FOR ZCC-CT INSERT							
2525 BDKT A ZT 3C (Ø36x48) t max:17	25	25	150	26.5	17	36	48								
2525 BDKT A ZT 3C (Ø48x70) t max:17	25	25	150	26.5	17	48	70								
2525 BDKT A ZT 3C (Ø70x110) t max:17	25	25	150	26.5	17	70	110								
2525 BDKT A ZT 3C (Ø100x150) t max:17	25	25	150	26.5	17	100	150								
2525 BDKT A ZT 3C (Ø150x200) t max:17	25	25	150	26.5	17	150	200								
<b>2525 BDKT A ZT 3C (Ø200x350) t max:17</b>	<b>25</b>	<b>25</b>	<b>150</b>	<b>26.5</b>	<b>17</b>	<b>200</b>	<b>350</b>					NEW	BKT V M6x25 9215	-	AA5
<b>2525 BDKT A ZT 3C (Ø300x500) t max:17</b>	<b>25</b>	<b>25</b>	<b>150</b>	<b>26.5</b>	<b>17</b>	<b>300</b>	<b>500</b>								
2525 BDKT A ZT 4C (Ø36x48) t max:22	25	25	150	26.5	22	36	48					ZTGD 4 ZCC-CT UCA UYGUNDUR FOR ZCC-CT INSERT			
2525 BDKT A ZT 4C (Ø48x70) t max:22	25	25	150	26.5	22	48	70								
2525 BDKT A ZT 4C (Ø70x110) t max:22	25	25	150	26.5	22	70	110								
2525 BDKT A ZT 4C (Ø100x150) t max:22	25	25	150	26.5	22	100	150								
2525 BDKT A ZT 4C (Ø150x200) t max:22	25	25	150	26.5	22	150	200								
<b>2525 BDKT A ZT 4C (Ø200x350) t max:22</b>	<b>25</b>	<b>25</b>	<b>150</b>	<b>26.5</b>	<b>22</b>	<b>200</b>	<b>350</b>	NEW	BKT V M6x25 9215	-	AA5				
<b>2525 BDKT A ZT 4C (Ø300x500) t max:22</b>	<b>25</b>	<b>25</b>	<b>150</b>	<b>26.5</b>	<b>22</b>	<b>300</b>	<b>500</b>								

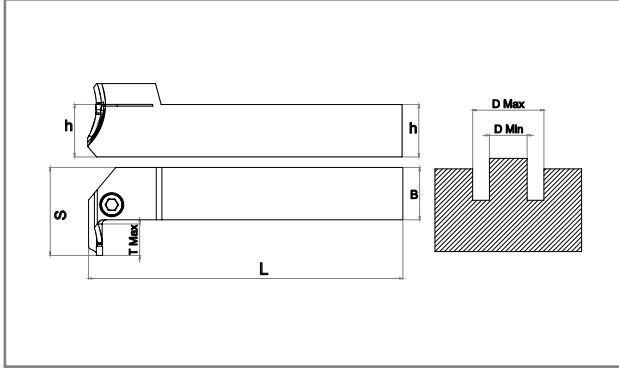

KOD CODE	ÖLÇÜLER DIMENSION (mm)							KESİCİ UÇ INSERT	YEDEK PARÇALAR SPARE PARTS						
	h	B	L	S	t max	øD min	øD max		Sıkma Vidası Clamp Screw	Pul Stamp	Anahtar Allen Key				
<b>BDKT LT ZCC-CT ZT..</b>															
2525 BDKT LT ZT 3C (Ø24x36) t max:17	25	25	150	26.5	17	24	36	ZTFD 3 ZCC-CT UCA UYGUNDUR FOR ZCC-CT INSERT							
2525 BDKT LT ZT 3C (Ø36x48) t max:17	25	25	150	26.5	17	36	48								
2525 BDKT LT ZT 3C (Ø48x70) t max:17	25	25	150	26.5	17	48	70								
2525 BDKT LT ZT 3C (Ø70x110) t max:17	25	25	150	26.5	17	70	110								
2525 BDKT LT ZT 3C (Ø100x150) t max:17	25	25	150	26.5	17	100	150								
2525 BDKT LT ZT 3C (Ø150x200) t max:17	25	25	150	26.5	17	150	200								
<b>2525 BDKT LT ZT 3C (Ø200x350) t max:17</b>	<b>25</b>	<b>25</b>	<b>150</b>	<b>26.5</b>	<b>17</b>	<b>200</b>	<b>350</b>					NEW	BKT V M6x25 9215	-	AA5
<b>2525 BDKT LT ZT 3C (Ø300x300) t max:17</b>	<b>25</b>	<b>25</b>	<b>150</b>	<b>26.5</b>	<b>17</b>	<b>300</b>	<b>500</b>								
2525 BDKT LT ZT 4C (Ø36x48) t max:20	25	25	150	26.5	20	36	48					ZTGD 4 ZCC-CT UCA UYGUNDUR FOR ZCC-CT INSERT			
2525 BDKT LT ZT 4C (Ø48x70) t max:20	25	25	150	26.5	20	48	70								
2525 BDKT LT ZT 4C (Ø70x110) t max:20	25	25	150	26.5	20	70	110								
2525 BDKT LT ZT 4C (Ø100x150) t max:20	25	25	150	26.5	20	100	150								
2525 BDKT LT ZT 4C (Ø150x200) t max:20	25	25	150	26.5	20	150	200								
<b>2525 BDKT LT ZT 4C (Ø200x350) t max:20</b>	<b>25</b>	<b>25</b>	<b>150</b>	<b>26.5</b>	<b>20</b>	<b>200</b>	<b>350</b>	NEW	BKT V M6x25 9215	-	AA5				
<b>2525 BDKT LT ZT 4C (Ø300x500) t max:20</b>	<b>25</b>	<b>25</b>	<b>150</b>	<b>26.5</b>	<b>20</b>	<b>300</b>	<b>500</b>								

## DIŞ ÇAP ALIN KANAL AÇMA TAKIMLARI Face External Grooving Toolholders



KOD CODE	ÖLÇÜLER DIMENSION (mm)							KESİCİ UÇ INSERT	YEDEK PARÇALAR SPARE PARTS		
	h	B	L	S	t max	øD min	øD max		Sıkma Vidası Clamp Screw	Pul Stamp	Anahtar Allen Key
<b>BDKT LT KRLY-MGM</b>											
2525 BDKT LT K3C (Ø24x36) t max:17	25	25	150	26.5	17	24	36	MGM 3C KRLY UCA UYGUNDUR FOR KRLY INSERT	BKTV M6x25 9215	-	AA5
2525 BDKT LT K3C (Ø36x48) t max:17	25	25	150	26.5	17	36	48				
2525 BDKT LT K3C (Ø48x70) t max:17	25	25	150	26.5	17	48	70				
2525 BDKT LT K3C (Ø70x110) t max:17	25	25	150	26.5	17	70	110				
2525 BDKT LT K3C (Ø100x150) t max:17	25	25	150	26.5	17	100	150				
2525 BDKT LT K3C (Ø150x200) t max:17	25	25	150	26.5	17	150	200				
<b>2525 BDKT LT K3C (Ø200x350) t max:17</b>	<b>25</b>	<b>25</b>	<b>150</b>	<b>26.5</b>	<b>17</b>	<b>200</b>	<b>350</b>				
2525 BDKT LT K3C (Ø300x500) t max:17	25	25	150	26.5	17	300	500	MGM 4C KRLY UCA UYGUNDUR FOR KRLY INSERT	BKTV M6x25 9215	-	AA5
2525 BDKT LT K4C (Ø36x48) t max:20	25	25	150	26.5	20	36	48				
2525 BDKT LT K4C (Ø48x70) t max:20	25	25	150	26.5	20	48	70				
2525 BDKT LT K4C (Ø70x110) t max:20	25	25	150	26.5	20	70	110				
2525 BDKT LT K4C (Ø100x150) t max:20	25	25	150	26.5	20	100	150				
2525 BDKT LT K4C (Ø150x200) t max:20	25	25	150	26.5	20	150	200				
<b>2525 BDKT LT K4C (Ø200x350) t max:20</b>	<b>25</b>	<b>25</b>	<b>150</b>	<b>26.5</b>	<b>20</b>	<b>200</b>	<b>350</b>				
2525 BDKT LT K4C (Ø300x500) t max:20	25	25	150	26.5	20	300	500				

**Teknoloji profesyonellikle birleŖti**  
Technology combined with professionalism

[www.smoxh.com.tr](http://www.smoxh.com.tr)

## **DELİK İÇİ KANAL AÇMA TAKIMLARI**



Internal Grooving Toolholders



## DELİK İÇİ KANAL AÇMA TAKIMLARI

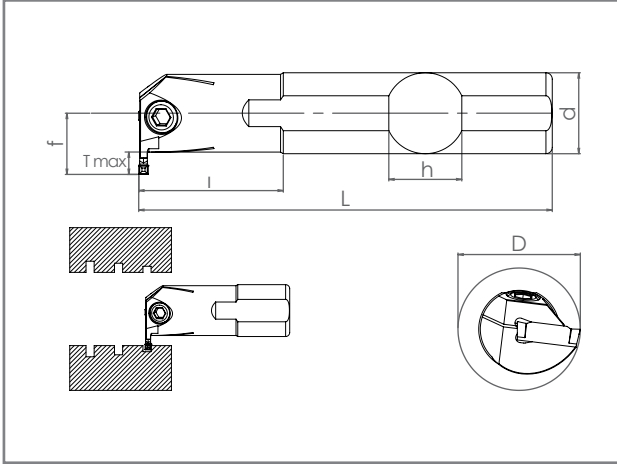

### Internal Grooving Toolholders





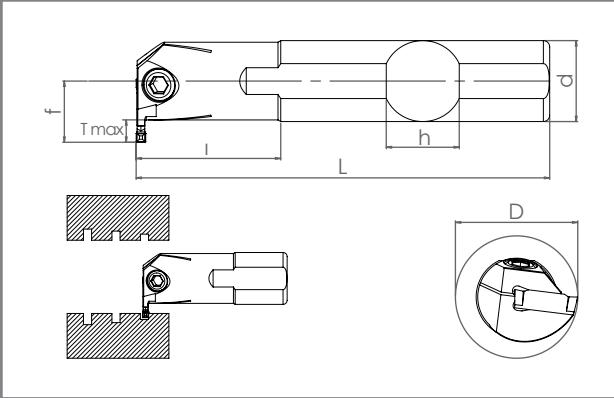

KOD CODE	ÖLÇÜLER DIMENSION (mm)							Kesici UÇ INSERT	YEDEK PARÇALAR SPARE PARTS	
	d	D	L	I	h	S	t max		Sıkma Vidası Clamp Screw	Anahtar Allen Key
<b>BIKT R/L KRLY-MGM</b>										
<b>BIKT R/L 16-K1.5C t max:4</b> <span style="color: green; font-weight: bold;">NEW</span>	16	20	150	33	15	11.5	4	<b>MGM 1.5C KRLY UCA UYGUNDUR FOR KRLY INSERT</b>	BKTV M4x14-9210	AA3
<b>BIKT R/L 20-K1.5C t max:6</b>	20	26	170	33	18	14.5	6		BKTV M5x17-9211	AA4
BIKT R/L 16-K2C t max:4	16	20	150	33	15	11.5	4	<b>MGM 2C KRLY UCA UYGUNDUR FOR KRLY INSERT</b>	BKTV M4x14-9211	AA3
BIKT R/L 20-K2C t max:6	20	26	170	33	18	14.5	6		BKTV M5x17-9211	AA4
BIKT R/L 25-K2C t max:7	25	32	200	45	23	18.5	7	<b>MGM 3C KRLY UCA UYGUNDUR FOR KRLY INSERT</b>	BKTV M6x22-9214	AA5
BIKT R/L 20-K3C t max:6	20	26	170	33	18	15	6		BKTV M5x17-9211	AA4
BIKT R/L 25-K3C t max:7	25	32	200	45	23	18.5	7	<b>MGM 3C KRLY UCA UYGUNDUR FOR KRLY INSERT</b>	BKTV M6x22-9214	AA5
BIKT R/L 32-K3C t max:8	32	40	250	49	30	22	8		BKTV M6x25-9215	AA5
BIKT R/L 40-K3C t max:10	40	48	300	54	37	27	10	<b>MGM 4C KRLY UCA UYGUNDUR FOR KRLY INSERT</b>	BKTV M8x30-9216	AA6
BIKT R/L 20-K4C t max:6	20	26	170	33	18	14	6		BKTV M5x17-9211	AA4
BIKT R/L 25-K4C t max:7	25	32	200	45	23	18.5	7	<b>MGM 4C KRLY UCA UYGUNDUR FOR KRLY INSERT</b>	BKTV M6x22-9214	AA5
BIKT R/L 32-K4C t max:8	32	40	250	49	30	22	8		BKTV M6x25-9215	AA5
BIKT R/L 40-K4C t max:10	40	48	300	54	37	27	10	<b>MGM 4C KRLY UCA UYGUNDUR FOR KRLY INSERT</b>	BKTV M8x30-9216	AA6
BIKT R/L 50-K4C t max:15	50	65	350	50	47	40	15		BKTV M6x22-9214	AA5
BIKT R/L 25-K5C t max:7	25	32	200	45	23	18.5	7	<b>MGM 5C KRLY UCA UYGUNDUR FOR KRLY INSERT</b>	BKTV M6x25-9215	AA5
BIKT R/L 32-K5C t max:8	32	40	250	49	30	22	8		BKTV M8x30-9216	AA6
BIKT R/L 40-K5C t max:10	40	48	300	54	37	27	10	<b>MGM 5C KRLY UCA UYGUNDUR FOR KRLY INSERT</b>	BKTV M8x30-9216	AA6
BIKT R/L 50-K5C t max:15	50	65	350	50	47	40	15		BKTV M8x30-9216	AA6
BIKT R/L 50-K6C t max:15	50	65	350	50	47	40	15	<b>MGM 6C KRLY UCA UYGUNDUR FOR KRLY INSERT</b>	BKTV M8x30-9216	AA6
BIKT R/L 50-K8C t max:15	50	65	350	50	47	40	15	<b>MGM 8C KRLY UCA UYGUNDUR FOR KRLY INSERT</b>		

## DELİK İÇİ KANAL AÇMA TAKIMLARI Internal Grooving Toolholders

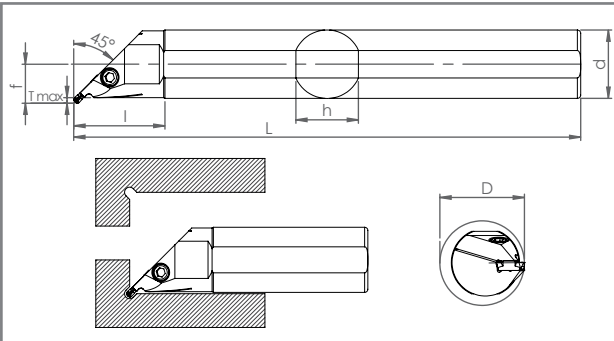





KOD CODE	ÖLÇÜLER DIMENSION (mm)							KESİCİ UÇ INSERT	YEDEK PARÇALAR SPARE PARTS	
	d	D	L	l	h	S	t max		Sıkma Vidası Clamp Screw	Anahtar Allen Key
<b>BIKT R/L KRLY-KGM</b>										
BIKT R/L 20-KG-2C t max:6	20	26	170	33	18	15	6	KGM 2C KRLY UCA UYGUNDUR FOR KRLY INSERT	BKTV M5x17-9211	AA4
BIKT R/L 25-KG-2C t max:7	25	26	200	42	23	18.5	7		KGM 3C KRLY UCA UYGUNDUR FOR KRLY INSERT	BKTV M6x22-9214
BIKT R/L 25-KG-3C t max:7	25	26	200	42	23	18.5	7	KGM 4C KRLY UCA UYGUNDUR FOR KRLY INSERT		BKTV M6x25-9215
BIKT R/L 32-KG-3C t max:8	32	40	250	49	30	22	8		KGM 4C KRLY UCA UYGUNDUR FOR KRLY INSERT	BKTV M6x22-9214
BIKT R/L 25-KG-4C t max:7	25	32	200	42	23	18	7	BKTV M6x25-9215		
BIKT R/L 32-KG-4C t max:8	32	40	250	49	30	22	8	BKTV M6x25-9215		



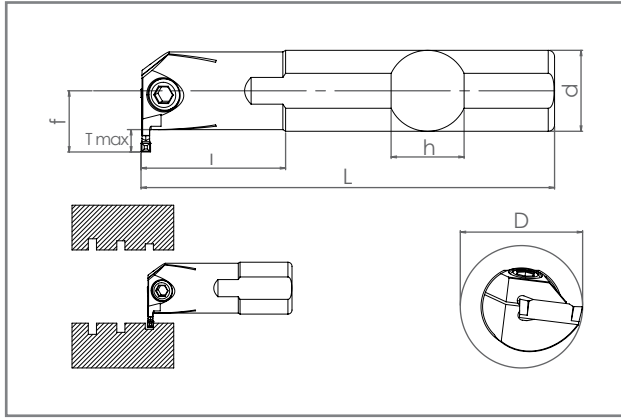



KOD CODE	ÖLÇÜLER DIMENSION (mm)							KESİCİ UÇ INSERT	YEDEK PARÇALAR SPARE PARTS	
	d	D	L	l	h	S	t max		Sıkma Vidası Clamp Screw	Anahtar Allen Key
<b>BIRT R/L KRLY-MRMN</b>										
BIRT R/L 20-KR-3C t max:3.5	20	26	170	33	18	15	3.5	MR. 3C KRLY UCA UYGUNDUR FOR KRLY INSERT	BKTV M4x14-9211	AA3
BIRT R/L 25-KR-3C t max:3.5	25	26	200	42	23	18.5	3.5		BKTV M5x17-9211	AA4
BIRT R/L 32-KR-3C t max:3.5	32	40	250	49	30	22	3.5	MR. 4C KRLY UCA UYGUNDUR FOR KRLY INSERT	BKTV M6x25-9215	AA5
BIRT R/L 40-KR-3C t max:3.5	40	48	300	54	37	27	10		BKTV M4x14-9211	AA3
BIRT R/L 20-KR-4C t max:3.5	20	26	170	33	18	15	3.5	MR. 5C KRLY UCA UYGUNDUR FOR KRLY INSERT	BKTV M5x17-9211	AA4
BIRT R/L 25-KR-4C t max:3.5	25	26	200	42	23	18.5	3.5		BKTV M6x25-9215	AA5
BIRT R/L 32-KR-4C t max:3.5	32	40	250	49	30	22	3.5	MR. 5C KRLY UCA UYGUNDUR FOR KRLY INSERT	BKTV M5x17-9211	AA4
BIRT R/L 40-KR-4C t max:3.5	40	48	300	54	37	27	10		BKTV M6x25-9215	AA5
BIRT R/L 32-KR-5C t max:3.5	32	40	250	49	30	22	3.5	MR. 5C KRLY UCA UYGUNDUR FOR KRLY INSERT	BKTV M5x17-9211	AA4
BIRT R/L 40-KR-5C t max:3.5	40	48	300	54	37	27	10		BKTV M6x25-9215	AA5

## DELİK İÇİ KANAL AÇMA TAKIMLARI Internal Grooving Toolholders

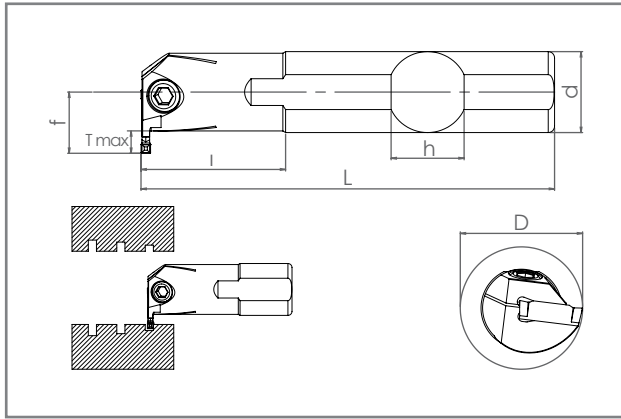

KOD CODE	ÖLÇÜLER DIMENSION (mm)							KESİCİ UÇ INSERT	YEDEK PARÇALAR SPARE PARTS	
	d	D	L	I	H	S	t max		Sıkma Vidası Clamp Screw	Anahtar Allen Key
<b>BIKT R/L HORN-S229</b>										
BIKT R/L 25-H3C (S229) t max:7	25	32	200	43	23	18.9	7	<b>S229.03 HORN UCA UYGUNDUR FOR HORN INSERT</b>	BKTV M6x22-9214	AA5
BIKT R/L 32-H3C (S229) t max:8	32	40	250	65	30	21.5	8		BKTV M6x25-9215	
BIKT R/L 40-H3C (S229) t max:10	40	48	300	50	37	26.5	10		BKTV M8x30-9216	AA6
BIKT R/L 25-H4C (S229) t max:7	25	31	200	40	23	18.9	7	<b>S229.04 HORN UCA UYGUNDUR FOR HORN INSERT</b>	BKTV M6x22-9214	AA5
BIKT R/L 32-H4C (S229) t max:8	32	37	250	65	30	21.5	8		BKTV M6x25-9215	
BIKT R/L 40-H4C (S229) t max:10	40	40	300	50	37	26.5	10		BKTV M8x30-9216	AA6
BIKT R/L 25-H5C (S229) t max:7	25	32	200	45	23	18.9	7	<b>S229.05 HORN UCA UYGUNDUR FOR HORN INSERT</b>	BKTV M6x22-9214	AA5
BIKT R/L 32-H5C (S229) t max:8	32	40	250	50	30	21.5	8		BKTV M6x25-9215	
BIKT R/L 40-H5C (S229) t max:10	40	50	300	70	37	26.5	10		BKTV M8x30-9216	AA6



KOD CODE	ÖLÇÜLER DIMENSION (mm)							KESİCİ UÇ INSERT	YEDEK PARÇALAR SPARE PARTS	
	d	D	L	I	H	S	t max		Sıkma Vidası Clamp Screw	Anahtar Allen Key
<b>BIKT R/L K.HORN-S224</b>										
BIKT R/L 20-HK2C (S224) t max:6	20	26	170	32	18	15	6	<b>S224.02 HORN UCA UYGUNDUR FOR HORN INSERT</b>	BKTV M5x17-9211	AA4
BIKT R/L 25-HK2C (S224) t max:7	25	32	200	42	23	18.9	7		BKTV M6x22-9214	AA5
BIKT R/L 20-HK3C (S224) t max:6	20	26	170	33	18	15	6	<b>S224.03 HORN UCA UYGUNDUR FOR HORN INSERT</b>	BKTV M5x17-9211	AA4
BIKT R/L 25-HK3C (S224) t max:7	25	32	200	43	23	18.9	7		BKTV M6x22-9214	AA5
BIKT R/L 32-HK3C (S224) t max:8	32	40	250	50	30	21.5	8		BKTV M6x25-9215	
BIKT R/L 20-HK4C (S224) t max:6	20	26	170	34	18	15	6	<b>S224.04 HORN UCA UYGUNDUR FOR HORN INSERT</b>	BKTV M5x17-9211	AA4
BIKT R/L 25-HK4C (S224) t max:7	25	32	200	40	23	18.9	7		BKTV M6x22-9214	AA5
BIKT R/L 32-HK4C (S224) t max:8	32	40	250	50	30	21.5	8		BKTV M6x25-9215	

## DELİK İÇİ KANAL AÇMA TAKIMLARI Internal Grooving Toolholders

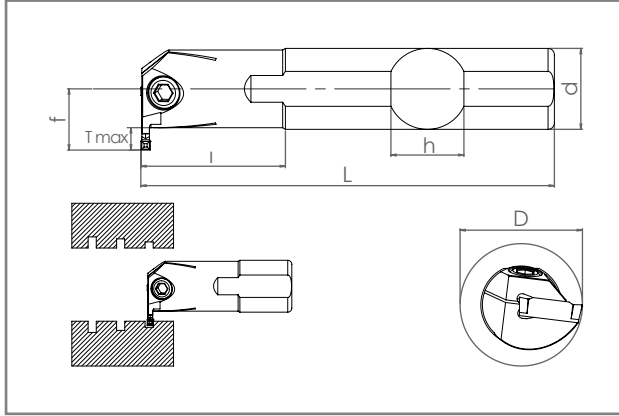

KOD CODE	ÖLÇÜLER DIMENSION (mm)							KESİCİ UÇ INSERT	YEDEK PARÇALAR SPARE PARTS	
	d	D	L	I	h	S	t max		Sıkma Vidası Clamp Screw	Anahtar Allen Key
<b>BIKT R/L TGTC-TDC</b>										
BIKT R/L 16-T2C t max:4	16	20	150	33	15	11.5	4	<b>TDC 2C TGTC UCA UYGUNDUR FOR TGTC INSERT</b>	BKTV M4x14-9210	AA3
BIKT R/L 20-T2C t max:6	20	26	170	33	18	14.5	6		BKTV M5x17-9211	AA4
BIKT R/L 25-T2C t max:7	25	32	200	45	23	18.5	7		BKTV M6x22-9214	AA5
BIKT R/L 20-T3C t max:6	20	26	170	33	18	15	6	<b>TDC 3C TGTC UCA UYGUNDUR FOR TGTC INSERT</b>	BKTV M5x17-9211	AA4
BIKT R/L 25-T3C t max:7	25	32	200	45	23	18.5	7		BKTV M6x22-9214	AA5
BIKT R/L 32-T3C t max:8	32	40	250	49	30	22	8		BKTV M6x25-9215	AA5
BIKT R/L 20-T4C t max:6	20	26	170	33	18	14	6	<b>TDC 4C TGTC UCA UYGUNDUR FOR TGTC INSERT</b>	BKTV M5x17-9211	AA4
BIKT R/L 25-T4C t max:7	25	32	200	45	23	18.5	7		BKTV M6x22-9214	AA5
BIKT R/L 32-T4C t max:8	32	40	250	49	30	22	8		BKTV M6x25-9215	AA5

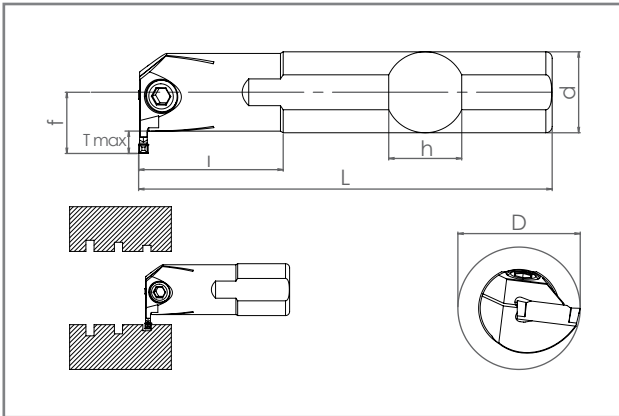





KOD CODE	ÖLÇÜLER DIMENSION (mm)							KESİCİ UÇ INSERT	YEDEK PARÇALAR SPARE PARTS	
	d	D	L	I	H	S	t max		Sıkma Vidası Clamp Screw	Anahtar Allen Key
<b>BIKT R/L ZCC-2</b>										
BIKT R/L 20-ZCC2-2C t max:6	20	26	170	32	18	15	6	<b>ZTDB 2 ZCC-CT UCA UYGUNDUR FOR ZCC-CT INSERTS</b>	BKTV M5x17-9211	AA4
BIKT R/L 20-ZCC2-3C t max:6	20	26	170	32	18	15	6		<b>ZTFD 3 ZCC-CT UCA UYGUNDUR FOR ZCC-CT INSERTS</b>	BKTV M6x22-9214
BIKT R/L 25-ZCC2-3C t max:7	25	32	200	42	23	18	7	BKTV M6x25-9215		AA5
BIKT R/L 32-ZCC2-3C t max:8	32	40	250	42	30	22	8	<b>ZTGD 4 ZCC-CT UCA UYGUNDUR FOR ZCC-CT INSERTS</b>		BKTV M6x22-9214
BIKT R/L 25-ZCC2-4C t max:7	25	32	200	42	23	18	7		BKTV M6x25-9215	AA5
BIKT R/L 32-ZCC2-4C t max:8	32	40	250	42	30	22	8	<b>ZTHD 5 ZCC-CT UCA UYGUNDUR FOR ZCC-CT INSERTS</b>	BKTV M6x25-9215	AA5
BIKT R/L 32-ZCC2-5C t max:8	32	40	250	42	30	22	8		BKTV M8x30-9216	AA6
BIKT R/L 40-ZCC2-4C t max:10	40	48	300	53	37	27	10			
BIKT R/L 40-ZCC2-5C t max:10	40	48	300	53	37	27	10			

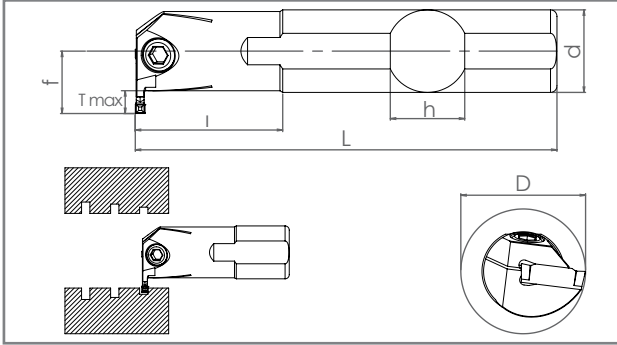

## DELİK İÇİ KANAL AÇMA TAKIMLARI Internal Grooving Toolholders



KOD CODE	ÖLÇÜLER DIMENSION (mm)							KESİCİ UÇ INSERT	YEDEK PARÇALAR SPARE PARTS	
	d	D	L	I	H	S	t max		Sıkma Vidası Clamp Screw	Anahtar Allen Key
<b>BIKT R/L GRIP / DGN</b>										
BIKT R/L 16-IG-3C t max:4	16	26	150	32	18	15	4	<b>GRIP 3C ISCR UCA UYGUNDUR FOR ISCR INSERT</b>	BKTV M4x14- <b>9210</b>	AA3
<b>BIKT R/L 20-IG-3C t max:6</b> 	20	26	170	32	18	15	6	<b>GRIP 3C ISCR UCA UYGUNDUR FOR ISCR INSERT</b>	BKTV M5x17- <b>9211</b>	AA4
<b>BIKT R/L 25-IG-3C t max:7</b>	25	32	200	42	23	18	7		BKTV M6x22- <b>9214</b>	
BIKT R/L 25-IG-4C t max:7	25	32	200	42	23	18	7	<b>GRIP 4C ISCR UCA UYGUNDUR FOR ISCR INSERT</b>	BKTV M6x22- <b>9214</b>	AA5
BIKT R/L 32-IG-4C t max:8	32	40	250	42	30	22	8		BKTV M6x25- <b>9215</b>	
BIKT R/L 20-ID-3C t max:6	20	26	170	32	18	15	6	<b>DGN 3C ISCR UCA UYGUNDUR FOR ISCR INSERT</b>	BKTV M5x17- <b>9211</b>	AA4
BIKT R/L 25-ID-3C t max:7	25	32	200	42	23	18	7		BKTV M6x22- <b>9214</b>	
BIKT R/L 32-ID-3C t max:8	32	40	250	42	30	22	8		BKTV M6x25- <b>9215</b>	AA5

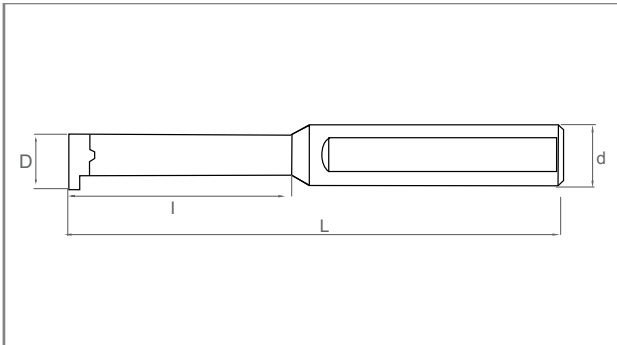

KOD CODE	ÖLÇÜLER DIMENSION (mm)			KESİCİ UÇ INSERT	YEDEK PARÇALAR SPARE PARTS	
	D	L	I		Sıkma Vidası Clamp Screw	Anahtar Torx Key
<b>BIKT KRLY NF..08-11-14-16</b>						
BIKT NF08 A12 L120 I20	12	120	13	<b>NFTG08 KRLY UCA UYGUNDUR / FOR KRLY INSERT</b>	SSV M2.5x6- <b>9505</b>	T08
BIKT NF11 A16 L120 I25	16	120	25	<b>NFTG11 KRLY UCA UYGUNDUR / FOR KRLY INSERT</b>	SSV M3.5x10- <b>9511</b>	T15
BIKT NF14 A16 L120 I30	16	120	30		<b>NFTG14 KRLY UCA UYGUNDUR / FOR KRLY INSERT</b>	
<b>BIKT NF16 A16 L120 I30</b> 	16	120	30	<b>NFTG16 KRLY UCA UYGUNDUR / FOR KRLY INSERT</b>	SSV M4x10- <b>9514</b>	
<b>BIKT SNDVK MB09</b> 						
BIKT MB09 A16 L120 I25	16	120	25	<b>MB09 SNDVK UCA UYGUNDUR / FOR SNDVK INSERT</b>	SSV M4x10- <b>9514</b>	T15
BIKT MB09 A16 L120 I30	16	120	30			
BIKT MB09 A16 L120 I40	16	120	40			

**Teknoloji profesyonellikle birleŖti**  
Technology combined with professionalism

[www.smoxh.com.tr](http://www.smoxh.com.tr)





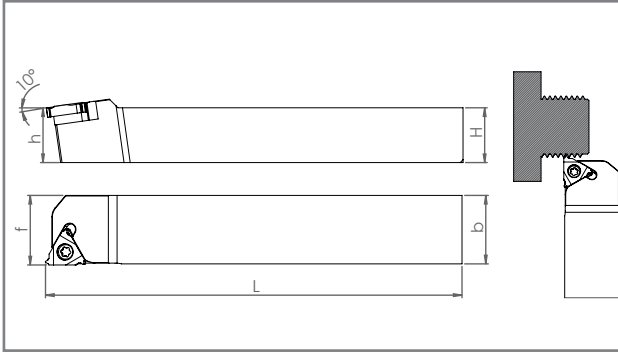

## **DIŖ ve İÇ ÇAP DIŖ AÇMA TAKIMLARI**

External and Internal Threading Toolholders







## DIŞ ve İÇ ÇAP DIŞ AÇMA TAKIMLARI External and Internal Threading Toolholders

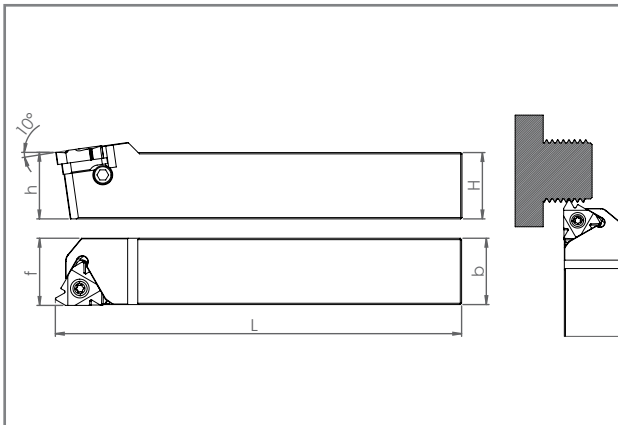

KOD CODE	ÖLÇÜLER DIMENSION (mm)				KESİCİ UÇ INSERT	YEDEK PARÇALAR SPARE PARTS				
	H=h	b	L	f		Sıkma Vidası Clamp Screw	Altık Shim	Altık Vidası Shim Screw	Anahtar Torx Key	
<b>SER/L</b>										
SER/L 0808 E11	08	08	70	10	11 ER/EL ISO	SSV M2.5x6 9505	-	-	T08	
SER/L 1010 E11	10	10	70	10						
SER/L 1212 F11	12	12	80	12						
SER/L 1616 H11	16	16	100	16						
SER/L 1616 H16	16	16	100	16	16 ER/EL ISO	SSV M3.5x10-9511	BAX ER/L-16 9623	SBV2 M5.05-A3.5x9 9408	T15	
SER/L 2020 K16	20	20	125	20				SSV M3.5x14 9512		SBV M5.05-A3.5x11 9407
SER/L 2525 M16	25	25	150	25						
SER/L 3232 P16	32	32	170	32						
<b>SER/L 2020 K22</b> 	20	20	125	20	22 ER/EL ISO	SSV M4x14 9516	BAX ER/L-22 9624	SBV M6.75-A4x13 9409	T20	
SER/L 2525 M22	25	25	150	25						
SER/L 3232 P22	32	32	170	32						
SER/L 4040 S22	40	40	250	40						
SER/L 3232 P27	32	32	170	32	27 ER/EL ISO	SSV M5x13 9519	BAX ER/L-27 9630	SBV5 M8x1-A5x13 9413	T20	
<b>SER/L 4040 S27</b> 	40	40	250	40						



KOD CODE	ÖLÇÜLER DIMENSION (mm)				KESİCİ UÇ INSERT	YEDEK PARÇALAR SPARE PARTS			
	H=h	B	L	f		Sıkma Vidası Clamp Screw	Altık Shim	Altık Vidası Shim Screw	Anahtar Torx Key
<b>TER/L</b>									
TER/L 1616 H16	16	16	100	16	16 ER/EL ISO	SSV M3.5x10 9511	BAX TER-16-9625 TEL-16-9626	TASV1 M3x9 9220	T15
TER/L 2020 K16	20	20	125	20					
TER/L 2525 M16	25	25	150	25					
TER/L 3232 P16	32	32	170	32					
TER/L 2525 M22	25	25	150	25	22 ER/EL ISO	SSV M4x14 9516	BAX TER-22-9627 TEL-22-9628	TASV2 M4x14 9221	T15
TER/L 3232 P22	32	32	170	32					
TER/L 4040 S22	40	40	250	40					

## DIŞ ve İÇ ÇAP DIŞ AÇMA TAKIMLARI External and Internal Threading Toolholders

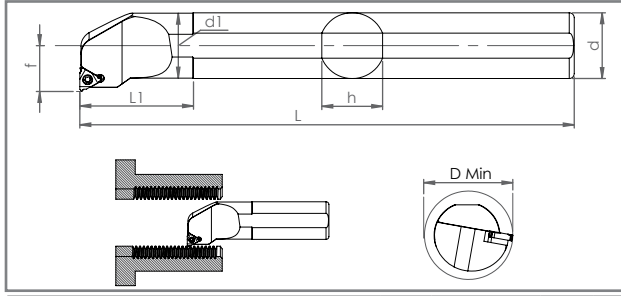

KOD CODE	ÖLÇÜLER DIMENSION (mm)							KESİCİ UÇ INSERT	YEDEK PARÇALAR SPARE PARTS				
	SIR/L	d	d1	h	L	f	L1		D min	Sıkma Vidası Clamp Screw	Altık Shim	Altık Vidası Shim Screw	Anahtar Allen Key
S16X07M SIR/L-08	16	7	15	150	5.3	18	7.8	08 IR/IL ISO	SSV M2.2x5-9503				T07
S10K SIR/L-11	10	10	09	125	7	-	12	11 IR/IL ISO	SSV M2.5x6 9505				T08
S12K SIR/L-11	12	12	11	125	10	-	16						
S16x10M SIR/L-11	16	10	15	150	7	32	12	16 IR/IL ISO	SSV M3.5x8-9510				T15
S16x13M SIR/L-11	16	13	15	150	9	32	15						
S16x13M SIR/L-16	16	16	15	150	10	32	16						
S16M SIR/L-16	16	13	15	150	11	-	19						
S20x16P SIR/L-16	20	16	18	170	11	35	19						
S20P SIR/L-16	20	20	18	170	14	-	24						
S25R SIR/L-16	25	25	23	200	16.5	-	29						
S32S SIR/L-16	32	32	30	250	20	-	36						
S40T SIR/L-16	40	40	37	300	24	-	44						
S20P SIR/L-22	20	20	18	170	14	-	24	22 IR/IL ISO	SSV M4x12 9515				T20
S25R SIR/L-22	25	25	23	200	16.5	-	29						
S32S SIR/L-22	32	32	30	250	20	-	38						
S40T SIR/L-22	40	40	37	300	24	-	46						
S32S SIR/L-27	32	32	30	250	20	-	38	27 ER/EL ISO	SSV M5x13 9519	BAX ER/L-27 9624	SBV2 M5.05-A3.5x9 9408 SBV M5.05-A3.5x11 9407		T20
S40T SIR/L-27	40	40	37	300	24	-	46						

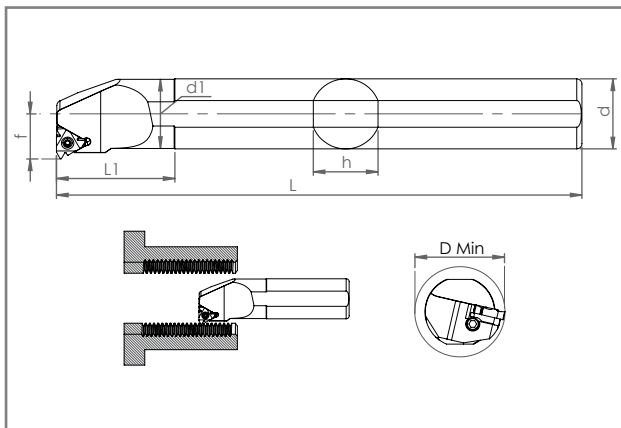

KOD CODE	ÖLÇÜLER DIMENSION (mm)							KESİCİ UÇ INSERT	YEDEK PARÇALAR SPARE PARTS				
	TIR/L	d	d1	h	L	f	L1		D min	Sıkma Vidası Clamp Screw	Altık Shim	Altık Vidası Shim Screw	Anahtar Allen Key
S25R TIR/L-16	25	25	23	200	16.5	-	29	16 IR/IL ISO	SSV M3.5x10 9511	BAX TER-16-9625 TEL-16-9626	TASV1 M3x9 9220		T15
S32S TIR/L-16	32	32	30	250	20	-	36						
S40T TIR/L-16	40	40	37	300	24	-	44						
S25R TIR/L-22	25	25	23	200	16.5	-	29						
S32S TIR/L-22	32	32	30	250	20	-	38	22 IR/IL ISO	SSV M4x14 9516	BAX TER-22-9627 TEL-22-9628	TASV2 M4x14 9221		T15
S40T TIR/L-22	40	40	37	300	24	-	46						

**Teknoloji profesyonellikle birleŖti**  
Technology combined with professionalism

[www.smoxh.com.tr](http://www.smoxh.com.tr)

## **DEĐIŐKEN UCLU FREZELER**



End Mills with changeable insert

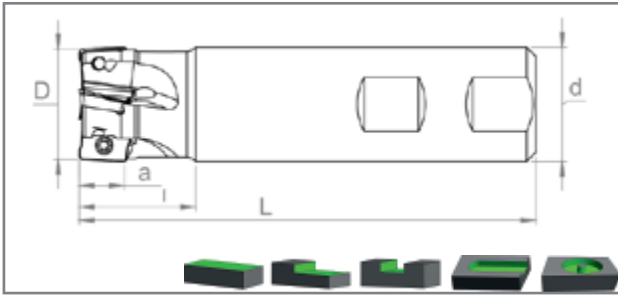

## DEĞİŞKEN UCLU FREZELER

### End Mills with changeable insert













KOD CODE	ÖLÇÜLER DIMENSION (mm)						KESİCİ UÇ INSERT	YEDEK PARÇALAR SPARE PARTS	
	D	d	Z	L	l	a		Sıkma Vidası Clamp Screw	Anahtar Torx Key
<b>ST90 AP.. 1003.-ISO</b>									
ST90 AP10 D12 W12 L120 Z01	12	12	1	120	30	10	AP.. 1003. ISO UCA UYGUNDUR FOR ISO INSERT	SSV M2.5x5-9504	T08
ST90 AP10 D12 W16 L120 Z01	12	16	1	120	30	10			
ST90 AP10 D14 W16 L120 Z01	14	16	1	120	30	10			
ST90 AP10 D16 W16 L120 Z02	16	16	2	120	30	10			
ST90 AP10 D16 W16 L120 Z02-H	16	16	2	120	30	10			
ST90 AP10 D18 W16 L120 Z02	18	16	2	120	25	10			
ST90 AP10 D20 W20 L120 Z03	20	20	3	120	30	10			
ST90 AP10 D20 W20 L120 Z03-H	20	20	3	120	30	10			
ST90 AP10 D22 W20 L120 Z03	22	20	3	120	25	10			
ST90 AP10 D23 W20 L120 Z03	23	20	3	120	25	10			
ST90 AP10 D24 W20 L120 Z03	24	20	3	120	30	10			
ST90 AP10 D25 W25 L120 Z03	25	25	3	120	30	10			
ST90 AP10 D25 W25 L120 Z03-H	25	25	3	120	30	10			
ST90 AP10 D26 W25 L120 Z03-H	26	25	3	120	25	10			
ST90 AP10 D30 W25 L120 Z04	30	25	4	120	30	10			
ST90 AP10 D32 W25 L120 Z04	32	25	4	120	30	10			
ST90 AP10 D32 W32 L120 Z04	32	32	4	120	30	10			
ST90 AP10 D32 W32 L120 Z04-H	32	32	4	120	30	10			
ST90 AP10 D35 W32 L120 Z05	35	32	5	120	30	10			
ST90 AP10 D40 W32 L120 Z05	40	32	5	120	30	10			
ST90 AP10 D16 W16 L150 Z02	16	16	2	150	40	10			
ST90 AP10 D16 W16 L150 Z02-H	16	16	2	150	40	10			
ST90 AP10 D17 W16 L150 Z02	17	16	2	150	25	10			
ST90 AP10 D18 W16 L150 Z02	18	16	2	150	25	10			
ST90 AP10 D20 W20 L150 Z03	20	20	3	150	40	10			
ST90 AP10 D20 W20 L150 Z03-H	20	20	3	150	40	10			
ST90 AP10 D21 W20 L150 Z03	21	20	3	150	25	10			
ST90 AP10 D22 W20 L150 Z03	22	20	3	150	25	10			
ST90 AP10 D24 W20 L150 Z03	24	20	3	150	25	10			
ST90 AP10 D25 W25 L150 Z03	25	25	3	150	40	10			
ST90 AP10 D25 W25 L150 Z03-H	25	25	3	150	40	10			
ST90 AP10 D26 W25 L150 Z03	26	25	3	150	25	10			
ST90 AP10 D30 W25 L150 Z04	30	25	4	150	40	10			
ST90 AP10 D32 W25 L150 Z04	32	25	4	150	40	10			
ST90 AP10 D32 W32 L150 Z04	32	32	4	150	40	10			
ST90 AP10 D32 W32 L150 Z04-H	32	32	4	150	40	10			
ST90 AP10 D40 W32 L150 Z05	40	32	5	150	40	10			
ST90 AP10 D16 C16 L200 Z02	16	16	2	200	50	10			
ST90 AP10 D16 C16 L200 Z02-H	16	16	2	200	50	10			
ST90 AP10 D17 C16 L200 Z02	17	16	2	200	25	10			
ST90 AP10 D18 C16 L200 Z02-H	18	16	2	200	25	10			
ST90 AP10 D20 C20 L200 Z03-H	20	20	3	200	50	10			
ST90 AP10 D21 C20 L200 Z03	21	20	3	200	25	10			
ST90 AP10 D22 C20 L200 Z03	22	20	3	200	25	10			
ST90 AP10 D24 C20 L200 Z03	24	20	3	200	25	10			
ST90 AP10 D25 C25 L200 Z03	25	25	3	200	50	10			
ST90 AP10 D26 C25 L200 Z03	26	25	3	200	25	10			
ST90 AP10 D25 C25 L250 Z03	25	25	3	250	70	10			
ST90 AP10 D32 C32 L300 Z04	32	32	4	300	70	10			

## DEĞİŞKEN UCLU FREZELER

End Mills with changeable insert





KOD CODE	ÖLÇÜLER DIMENSION (mm)						KESİCİ UÇ INSERT	YEDEK PARÇALAR SPARE PARTS				
	D	d	Z	L	l	a		Sıkma Vidası Clamp Screw	Anahtar Torx Key			
<b>ST90 APMT 0602 / 11T3 / 1135..</b>												
ST90 AP06 D10 C10 L120 Z02	10	10	2	120	30	6	APMT 11T3. KRLY UCA UYGUNDUR FOR KRLY INSERT	SSV M1.8x4-9501	T06			
ST90 AP06 D12 C12 L120 Z02	12	12	2	120	30	6						
ST90 AP11 D16 W16 L120 Z02	16	16	2	120	30	11						
<b>ST90 AP11 D16 W16 L120 Z02-H</b> 	16	16	2	120	30	11						
ST90 AP11 D20 W20 L120 Z03	20	20	3	120	30	11						
<b>ST90 AP11 D20 W20 L120 Z03-H</b> 	20	20	3	120	30	11						
ST90 AP11 D25 W25 L120 Z03	25	25	3	120	30	11						
<b>ST90 AP11 D25 W25 L120 Z03-H</b> 	25	25	3	120	30	11						
ST90 AP11 D26 W25 L120 Z03	26	25	3	120	30	11						
ST90 AP11 D32 W32 L120 Z04	32	32	4	120	30	11						
ST90 AP11 D16 W16 L150 Z02	16	16	2	150	40	11						
<b>ST90 AP11 D16 W16 L150 Z02-H</b> 	16	16	2	150	40	11						
ST90 AP11 D20 W20 L150 Z03	20	20	3	150	40	11						
<b>ST90 AP11 D20 W20 L150 Z03-H</b> 	20	20	3	150	40	11						
ST90 AP11 D25 W25 L150 Z03	25	25	3	150	40	11						
<b>ST90 AP11 D25 W25 L150 Z03-H</b> 	25	25	3	150	40	11						
ST90 AP11 D26 W25 L150 Z03	26	25	3	150	30	11						
ST90 AP11 D32 W32 L150 Z04	32	32	4	150	40	11						
ST90 AP11 D16 C16 L200 Z02	16	16	2	200	50	11						
ST90 AP11 D20 C20 L200 Z03	20	20	3	200	50	11						
ST90 AP11 D25 C25 L200 Z03	25	25	3	200	50	11						
ST90 AP11 D26 C25 L200 Z03	26	25	3	200	30	11						
ST90 AP11 D32 C32 L200 Z04	32	32	4	200	50	11						
<b>ST90 APMT11 D16 W16 L120 Z02-H</b>	16	16	2	120	30	11		SSV M2.5x6 9505	T08			
<b>ST90 APMT11 D18 W16 L120 Z02-H</b>	18	16	2	120	25	11						
<b>ST90 APMT11 D20 W20 L120 Z03-H</b>	20	20	3	120	30	11						
<b>ST90 APMT11 D25 W25 L120 Z04-H</b>	25	25	4	120	30	11						
<b>ST90 APMT11 D16 W16 L150 Z02-H</b>	16	16	2	150	40	11						
<b>ST90 APMT11 D17 W16 L150 Z02-H</b>	17	16	2	150	25	11						
<b>ST90 APMT11 D18 W16 L150 Z02-H</b>	18	16	2	150	25	11						
<b>ST90 APMT11 D20 W20 L150 Z03-H</b>	20	20	3	150	40	11						
<b>ST90 APMT11 D21 W20 L150 Z03-H</b>	21	20	3	150	25	11						
<b>ST90 APMT11 D25 W25 L150 Z04-H</b>	25	25	4	150	40	11						
<b>ST90 APMT11 D26 W25 L150 Z04-H</b>	26	25	4	150	25	11						
<b>ST90 APMT11 D16 C16 L200 Z02</b>	16	16	2	200	50	11						
<b>ST90 APMT11 D17 C16 L200 Z02</b>	17	16	2	200	30	11						
<b>ST90 APMT11 D20 C20 L200 Z03</b>	20	20	3	200	50	11						
<b>ST90 APMT11 D21 C20 L200 Z03</b>	21	20	3	200	30	11						
<b>ST90 APMT11 D25 C25 L200 Z04</b>	25	25	4	200	50	11						
<b>ST90 APMT11 D26 C25 L200 Z04</b>	26	25	4	200	30	11						
										APMT 1135.. YG-1 UCA UYGUNDUR FOR YG-1 INSERT		

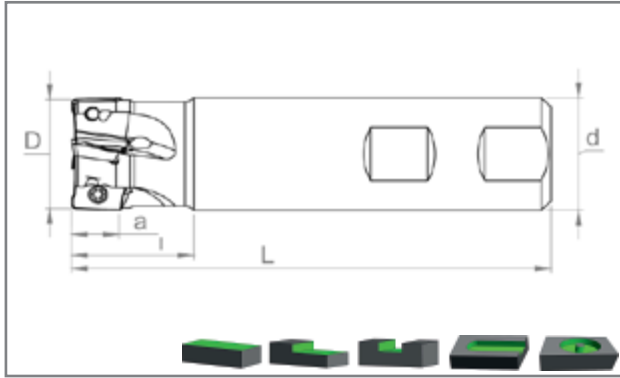

## DEĞİŞKEN UCLU FREZELER

### End Mills with changeable insert

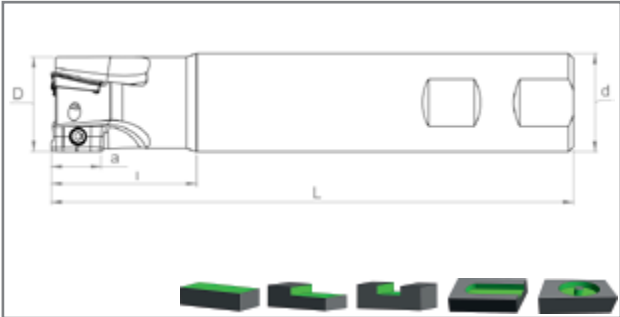

KOD CODE	ÖLÇÜLER DIMENSION (mm)						KESİCİ UÇ INSERT	YEDEK PARÇALAR SPARE PARTS		
	D	d	Z	L	l	a		Sıkma Vidası Clamp Screw	Anahtar Torx Key	
<b>ST90 APKT 09T3..</b>										
ST90 AP09T3 D16 W16 L150 Z02-H	16	16	2	150	40	9	APKT 09T3.. TGTC UCA UYGUNDUR FOR TGTC INSERT	SSV M2.5x5-9504	T08	
ST90 AP09T3 D20 W20 L150 Z03-H	20	20	3	150	40	9		SSV M2.5x6 9505		
ST90 AP09T3 D16 C16 L200 Z02	16	16	2	200	50	9		APKT 1204.. TGTC UCA UYGUNDUR FOR TGTC INSERT	SSV M3.5x8-SC 9513	T10
ST90 AP09T3 D20 C20 L200 Z03	20	20	3	200	50	9				
ST90 AP12 D20 W20 L150 Z02	20	20	2	150	40	12				
ST90 AP12 D21 W20 L150 Z02	21	20	2	150	30	12				
ST90 AP12 D25 W25 L150 Z03	25	25	3	150	40	12				
ST90 AP12 D32 W32 L150 Z04	32	32	4	150	40	12				
ST90 AP12 D21 C20 L200 Z02	21	20	2	200	30	12				
ST90 AP12 D26 C25 L200 Z03	26	25	3	200	30	12				

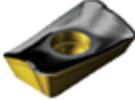

KOD CODE	ÖLÇÜLER DIMENSION (mm)						KESİCİ UÇ INSERT	YEDEK PARÇALAR SPARE PARTS	
	D	d	Z	L	l	a		Sıkma Vidası Clamp Screw	Anahtar Torx Key
<b>ST90 R390 11T3 / 1704..</b>									
ST90 R390.11 D16 W16 L100 Z02-H	16	16	2	100	30	10	R390.11T3.. SDVK UCA UYGUNDUR FOR SDVK INSERT	SSV M2.5x5-9504	T08
ST90 R390.11 D20 W20 L100 Z03-H	20	20	3	100	30	10		SSV M2.5x6 9505	
ST90 R390.11 D20 W20 L110 Z03-H	20	20	3	110	30	10		SSV M2.5x5-9504	
ST90 R390.11 D25 W25 L100 Z03-H	25	25	3	100	30	10			
ST90 R390.11 D16 W16 L150 Z02	16	16	2	150	40	10		SSV M2.5x6 9505	T15
ST90 R390.11 D16 W16 L150 Z02-H	16	16	2	150	40	10			
ST90 R390.11 D20 W20 L150 Z03	20	20	3	150	40	10			
ST90 R390.11 D20 W20 L150 Z03-H	20	20	3	150	40	10			
ST90 R390.11 D25 W25 L150 Z03	25	25	3	150	40	10			
ST90 R390.11 D25 W25 L150 Z03-H	25	25	3	150	40	10			
ST90 R390.17 D25 W25 L150 Z02	25	25	2	150	40	15.7	R390.1704.. SDVK UCA UYGUNDUR FOR SDVK INSERT	SSV M3.5x8 9510	T15
ST90 R390.17 D25 W25 L150 Z02-H	25	25	2	150	40	15.7			
ST90 R390.17 D30 W25 L150 Z03	30	25	3	150	30	15.7			
ST90 R390.17 D30 W25 L150 Z03-H	30	25	3	150	30	15.7			



## DEĞİŞKEN UCLU FREZELER

End Mills with changeable insert

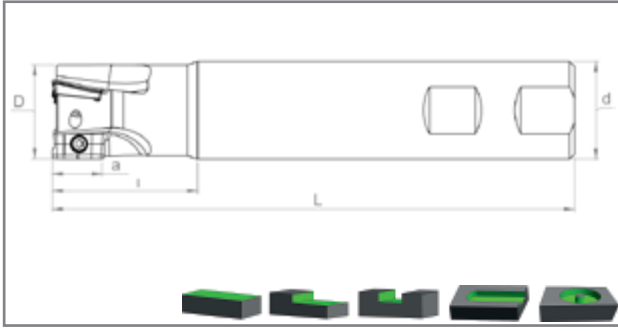

KOD CODE	ÖLÇÜLER DIMENSION (mm)						KESİCİ UÇ INSERT	YEDEK PARÇALAR SPARE PARTS	
	D	d	Z	L	l	a		Sıkma Vidası Clamp Screw	Anahtar Torx Key
<b>ST90 APKT 0602..</b>									
ST90 APKT06 D10 W10 L120 Z02-H	10	10	2	120	30	5.5	APKT 0602.. LMN UCA UYGUNDUR FOR LMN INSERT	SSV M1.8x4 9501	T06
ST90 APKT06 D11 W10 L120 Z02-H	11	10	2	120	30	5.5			
ST90 APKT06 D12 W12 L120 Z03-H	12	12	3	120	30	5.5			
ST90 APKT06 D13 W12 L120 Z04-H	13	12	4	120	25	5.5			
<b>ST90 APKT 11T3..</b>									
ST90 APKT11 D16 W16 L150 Z02-H	16	16	2	150	40	11	APKT 11T3.. ZCC-CT UCA UYGUNDUR FOR ZCC-CT INSERT	SSV M2.5x6 9505	T08
ST90 APKT11 D17 W16 L150 Z02-H	17	16	2	150	30	11			
ST90 APKT11 D20 W20 L150 Z03-H	20	20	3	150	40	11			
ST90 APKT11 D21 W20 L150 Z03-H	21	20	3	150	30	11			
ST90 APKT11 D25 W25 L150 Z04-H	25	25	4	150	40	11			
ST90 APKT11 D26 W25 L150 Z04-H	26	25	4	150	30	11			
ST90 APKT11 D32 W32 L150 Z05-H	32	32	5	150	40	11			

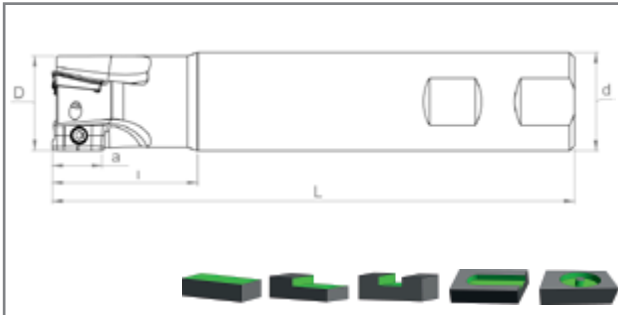



KOD CODE	ÖLÇÜLER DIMENSION (mm)						KESİCİ UÇ INSERT	YEDEK PARÇALAR SPARE PARTS	
	D	d	Z	L	l	a		Sıkma Vidası Clamp Screw	Anahtar Torx Key
<b>ST90 APKT 1003 / 1604..</b>									
ST90 APKT10 D16 W16 L150 Z02-H	16	16	2	150	40	10	APKT 1003.. KYCR UCA UYGUNDUR FOR KYCR INSERT	SSV M2.5x6 9505	T08
ST90 APKT10 D20 W20 L150 Z03-H	20	20	3	150	40	10			
ST90 APKT10 D25 W25 L150 Z03-H	25	25	3	150	40	10			
ST90 APKT10 D32 W32 L150 Z04-H	32	32	4	150	40	10			
ST90 APKT16 D25 W25 L150 Z02-H	25	25	2	150	40	16	APKT 1604.. KYCR UCA UYGUNDUR FOR KYCR INSERT	SSV M3.5x10 9511	T15
ST90 APKT16 D32 W25 L150 Z03-H	32	25	3	150	30	16			
ST90 APKT16 D32 W32 L150 Z03-H	32	32	3	150	40	16			

## DEĞİŞKEN UCLU FREZELER

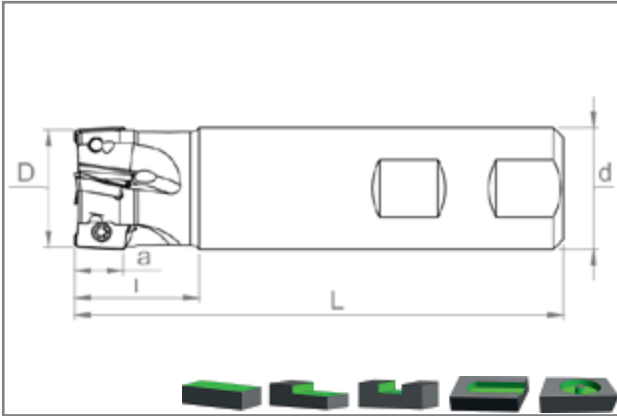
End Mills with changeable insert





KOD CODE	ÖLÇÜLER DIMENSION (mm)						KESİCİ UÇ INSERT	YEDEK PARÇALAR SPARE PARTS			
	D	d	Z	L	I	a		Sıkma Vidası Clamp Screw	Anahtar Torx Key		
<b>ST90 AP.. 1604-ISO / 1705..</b>											
ST90 AP16 D25 W25 L120 Z02	25	25	2	120	30	16	<b>AP. 1604.. ISO UCA UYGUNDUR FOR ISO INSERT</b>	SSV M3.5x8 <b>9508</b>	<b>T15</b>		
ST90 AP16 D26 W25 L120 Z02	26	25	2	120	30	16					
ST90 AP16 D28 W25 L120 Z02	28	25	2	120	30	16					
ST90 AP16 D30 W25 L120 Z03	30	25	3	120	30	16					
ST90 AP16 D32 W25 L120 Z03	32	25	3	120	30	16					
ST90 AP16 D32 W32 L120 Z03	32	32	3	120	30	16					
ST90 AP16 D34 W32 L120 Z03	34	32	3	120	30	16					
ST90 AP16 D35 W32 L120 Z03	35	32	3	120	30	16					
ST90 AP16 D36 W32 L120 Z03	36	32	3	120	30	16					
ST90 AP16 D38 W32 L120 Z04	38	32	4	120	30	16					
ST90 AP16 D40 W32 L120 Z04	40	32	4	120	30	16					
ST90 AP16 D25 W25 L150 Z02	25	25	2	150	40	16					
ST90 AP16 D26 W25 L150 Z02	26	25	2	150	30	16					
ST90 AP16 D28 W25 L150 Z02	28	25	2	150	30	16					
ST90 AP16 D30 W25 L150 Z03	30	25	3	150	30	16					
ST90 AP16 D32 W32 L150 Z03	32	32	3	150	40	16					
ST90 AP16 D32 W25 L150 Z03	32	25	3	150	30	16					
ST90 AP16 D34 W32 L150 Z03	34	32	3	150	30	16					
ST90 AP16 D35 W32 L150 Z03	35	32	3	150	40	16					
ST90 AP16 D40 W25 L150 Z04	40	25	4	150	40	16					
ST90 AP16 D40 W32 L150 Z04	40	32	4	150	40	16					
ST90 AP16 D25 C25 L200 Z02	25	25	2	200	50	16					
ST90 AP16 D26 C25 L200 Z02	26	25	2	200	30	16					
ST90 AP16 D28 C25 L200 Z02	28	25	2	200	30	16					
ST90 AP16 D30 C25 L200 Z03	30	25	3	200	30	16					
ST90 AP16 D32 C32 L200 Z03	32	32	3	200	50	16					
ST90 AP16 D34 C32 L200 Z03	34	32	3	200	30	16					
ST90 AP16 D35 C32 L200 Z03	35	32	3	200	30	16					
ST90 AP16 D40 C32 L200 Z04	40	32	4	200	30	16					
ST90 AP16 D25 C25 L250 Z02	25	25	2	250	100	16					
ST90 AP16 D32 C32 L250 Z03	32	32	3	250	100	16					
ST90 AP16 D32 C32 L300 Z03	32	32	3	300	100	16					
ST90 AP17 D25 W25 L120 Z02	25	25	2	120	30	17		<b>APKT 1705.. TGTC UCA UYGUNDUR FOR TGTC INSERT</b>		SSV M4x10 <b>9514</b>	<b>T15</b>
ST90 AP17 D32 W32 L150 Z03	32	32	3	150	40	17					
ST90 AP17 D26 C25 L200 Z02	26	25	2	200	30	17					
ST90 AP17 D26 C25 L250 Z02	26	25	2	250	50	17					
ST90 AP17 D30 C25 L300 Z02	30	25	2	300	50	17					

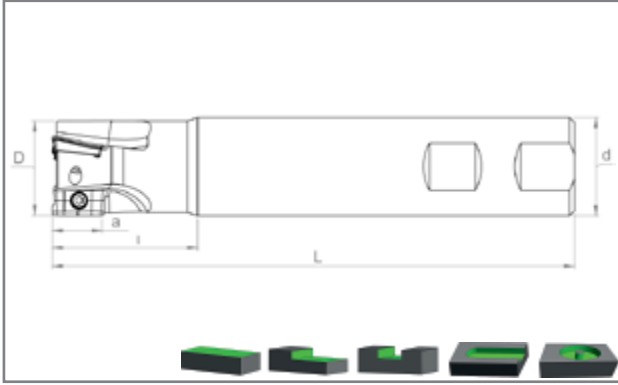

## DEĞİŞKEN UCLU FREZELER

End Mills with changeable insert

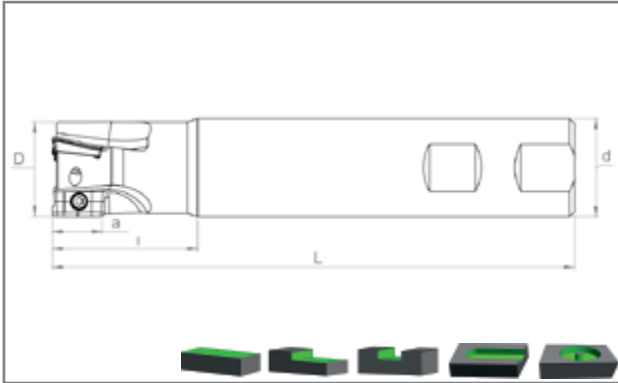

KOD CODE	ÖLÇÜLER DIMENSION (mm)						KESİCİ UÇ INSERT	YEDEK PARÇALAR SPARE PARTS	
	D	d	Z	L	I	a		Sıkma Vidası Clamp Screw	Anahtar Torx Key
<b>ST90 EDPT 10T3 / 1404..</b>									
ST90 ED10 D16 W16 L150 Z02-H	16	16	2	150	40	10	EDPT 10T3.. KNMTL UCA UYGUNDUR FOR KNMTLL INSERT	SSV M2.5x6 9505	T08
ST90 ED10 D20 W20 L150 Z03-H	20	20	3	150	40	10		SSV M2.5x7 9506	
ST90 ED10 D25 W25 L150 Z04-H	25	25	4	150	40	10			
ST90 ED10 D32 W32 L150 Z05-H	32	32	5	150	40	10			
ST90 ED14 D20 W20 L150 Z02-H	20	20	2	150	40	14	EDPT 1404.. KNMTL UCA UYGUNDUR FOR KNMTLL INSERT	SSV M3x6-9507	T08
ST90 ED14 D25 W25 L150 Z03-H	25	25	3	150	40	14		SSV M3x8-9508	
ST90 ED14 D32 W32 L150 Z04-H	32	32	4	150	40	14			
ST90 ED14 D40 W32 L150 Z05-H	40	32	5	150	30	14			



KOD CODE	ÖLÇÜLER DIMENSION (mm)						KESİCİ UÇ INSERT	YEDEK PARÇALAR SPARE PARTS	
	D	d	Z	L	I	a		Sıkma Vidası Clamp Screw	Anahtar Torx Key
<b>ST90 ADMX 0702 / 11T3 / 1606..</b>									
ST90 ADMX07 D10 C10 L120 Z02-H	10	10	2	120	30	7	ADMX 0702.. PRMT UCA UYGUNDUR FOR PRMT INSERT	SSV M2x5 9502	T06
ST90 ADMX07 D12 C12 L120 Z03-H	12	12	3	120	30	7		ADMX 11T3.. PRMT UCA UYGUNDUR FOR PRMT INSERT	
ST90 ADMX11 D20 W20 L150 Z02-H	20	20	2	150	40	10.5	SSV M2.5x7 9506		
ST90 ADMX11 D25 W25 L150 Z03-H	25	25	3	150	40	10.5			
ST90 ADMX11 D32 W32 L150 Z04-H	32	32	4	150	40	10.5	ADMX 1606.. PRMT UCA UYGUNDUR FOR PRMT INSERT	SSV M4x10 9514	T15
ST90 ADMX16 D25 W25 L150 Z02-H	25	25	2	150	40	16			
ST90 ADMX16 D32 W32 L150 Z03-H	32	32	3	150	40	16			

H-İÇTEN SU VERMELİ  
H-WITH COOLANT HOLE

## DEĞİŞKEN UCLU FREZELER

### End Mills with changeable insert

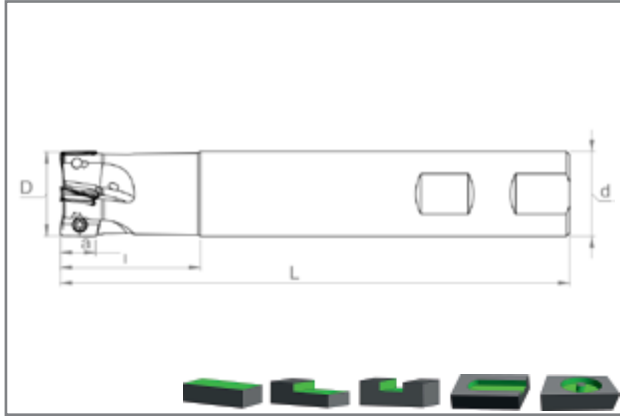

KOD CODE	ÖLÇÜLER DIMENSION (mm)						KESİCİ UÇ INSERT	YEDEK PARÇALAR SPARE PARTS		
	D	d	Z	L	l	a		Sıkma Vidası Clamp Screw	Anahtar Torx Key	
<b>ST90 AD.T 0803 / 10T3 / 1204..</b>										
ST90 AD08 D16 W16 L150 Z02-H	16	16	2	150	40	8	ADMT 0803.. WLTR UCA UYGUNDUR FOR WLTR INSERT	SSV M2.5x5 9504	T08	
ST90 AD08 D20 W20 L150 Z03-H	20	20	3	150	40	8				SSV-M2.5x6-9505
ST90 AD08 D25 W25 L150 Z04-H	25	25	4	150	40	8		SSV M2.5x5 9504		
ST90 AD08 D16 C16 L200 Z02	16	16	2	200	50	8				
ST90 AD08 D20 C20 L200 Z03	20	20	3	200	50	8				
ST90 AD10 D16 W16 L150 Z02-H	16	16	2	150	40	10	ADMT 10T3.. WLTR UCA UYGUNDUR FOR WLTR INSERT	SSV M2.5x6 9505		
ST90 AD10 D20 W20 L150 Z03-H	20	20	3	150	40	10				
ST90 AD10 D25 W25 L150 Z04-H	25	25	4	150	40	10				
ST90 AD12 D20 W20 L150 Z02	20	20	2	150	40	12	ADKT 1204.. WLTR UCA UYGUNDUR FOR WLTR INSERT	SSV M3x6-9507		
ST90 AD12 D25 W25 L150 Z03	25	25	3	150	40	12				
ST90 AD12 D30 W25 L150 Z04	30	25	4	150	30	12				
ST90 AD12 D32 W32 L150 Z04	32	32	4	150	40	12			SSV M3x8-9508	

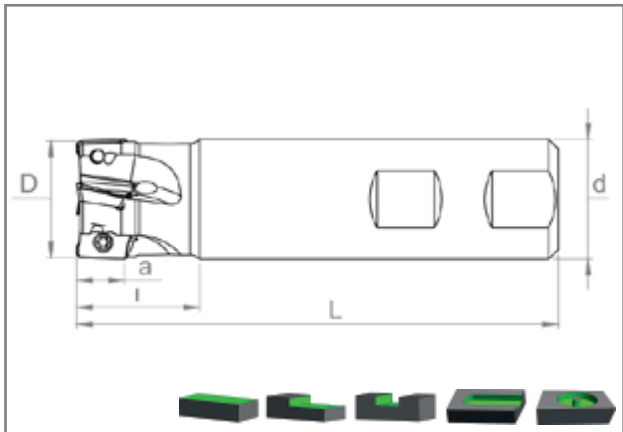





KOD CODE	ÖLÇÜLER DIMENSION (mm)						KESİCİ UÇ INSERT	YEDEK PARÇALAR SPARE PARTS	
	D	d	Z	L	l	a		Sıkma Vidası Clamp Screw	Anahtar Torx Key
<b>ST90 ADKT 1505..</b>									
ST90 AD1505 D25 W25 L120 Z02	25	25	2	120	30	14.3	ADKT 1505.. ISCR UCA UYGUNDUR FOR ISCR INSERT	SSV M4x10 9514	T15
ST90 AD1505 D32 W32 L120 Z03	32	32	3	120	30	14.3			
ST90 AD1505 D25 W25 L150 Z02	25	25	2	150	40	14.3			
ST90 AD1505 D30 W25 L150 Z03	30	25	3	150	30	14.3			
ST90 AD1505 D32 W32 L150 Z03	32	32	3	150	40	14.3			

H-İÇTEN SU VERMELİ  
H-WITH COOLANT HOLE

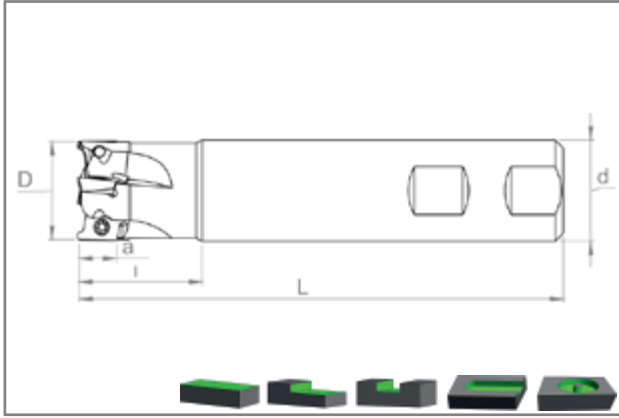
## DEĞİŞKEN UCLU FREZELER

End Mills with changeable insert



KOD CODE	ÖLÇÜLER DIMENSION (mm)						KESİCİ UÇ INSERT	YEDEK PARÇALAR SPARE PARTS	
<b>ST90 RT</b> <b>0702 / 1003 / 1606</b>	<b>D</b>	<b>d</b>	<b>Z</b>	<b>L</b>	<b>l</b>	<b>a</b>	 <b>RT 0702..</b> <b>SAFETY</b> <b>UCA UYGUNDUR</b> <b>FOR SAFETY INSERT</b>	Sıkma Vidası Clamp Screw	Anahtar Torx Key
	10	10	2	120	30	7			
	12	12	2	120	30	7		<b>SSV</b> <b>M2x5</b> <b>9502</b>	<b>T06</b>
	12	12	2	120	30	7			
	14	12	2	120	25	7			



ST90 RT10 D16 W16 L120 Z02	16	16	2	120	30	10	<b>RT 1003..</b> <b>SAFETY</b> <b>UCA UYGUNDUR</b> <b>FOR SAFETY INSERT</b>	<b>SSV</b> <b>M2.5x5</b> <b>9504</b>	<b>T08</b>
ST90 RT10 D18 W16 L120 Z02	18	16	2	120	25	10		<b>SSV</b> <b>M2.5x6</b> <b>9505</b>	
ST90 RT10 D20 W20 L120 Z03	20	20	3	120	30	10			
ST90 RT10 D22 W20 L120 Z03	22	20	3	120	25	10			
ST90 RT10 D25 W25 L120 Z04	25	25	4	120	30	10			
ST90 RT10 D32 W32 L120 Z05	32	32	5	120	30	10			
ST90 RT10 D16 W16 L150 Z02	16	16	2	150	40	10			
ST90 RT10 D17 W16 L150 Z02	17	16	2	150	25	10			
ST90 RT10 D20 W20 L150 Z03	20	20	3	150	40	10			
ST90 RT10 D22 W20 L150 Z03	22	20	3	150	25	10			
ST90 RT10 D25 W25 L150 Z04	25	25	4	150	40	10			
ST90 RT10 D32 W32 L150 Z05	32	32	5	150	40	10			
ST90 RT10 D16 C16 L200 Z02	16	16	2	200	50	10			
ST90 RT10 D20 C20 L200 Z03	20	20	3	200	50	10			
ST90 RT10 D22 C20 L200 Z03	22	20	3	200	25	10			
ST90 RT10 D25 C25 L200 Z04	25	25	4	200	50	10			
ST90 RT10 D32 C32 L200 Z05	32	32	5	200	50	10			

ST90 RT16 D25 W25 L120 Z02	25	25	2	120	30	16	<b>RT 1606</b> <b>SAFETY</b> <b>UCA UYGUNDUR</b> <b>FOR SAFETY INSERT</b>	<b>SSV</b> <b>M4x10</b> <b>9514</b>	<b>T15</b>
ST90 RT16 D32 W32 L120 Z03	32	32	3	120	30	16			
ST90 RT16 D40 W32 L120 Z04	40	32	4	120	30	16			
ST90 RT16 D25 W25 L150 Z02	25	25	2	150	40	16			
ST90 RT16 D32 W32 L150 Z03	32	32	3	150	40	16			
ST90 RT16 D40 W32 L150 Z04	40	32	4	150	30	16			
ST90 RT16 D25 C25 L200 Z02	25	25	2	200	50	16			
ST90 RT16 D32 C32 L200 Z03	32	32	3	200	40	16			
ST90 RT16 D40 C32 L200 Z04	40	32	4	200	30	16			
ST90 RT16 D32 C32 L250 Z03	32	32	3	250	50	16			

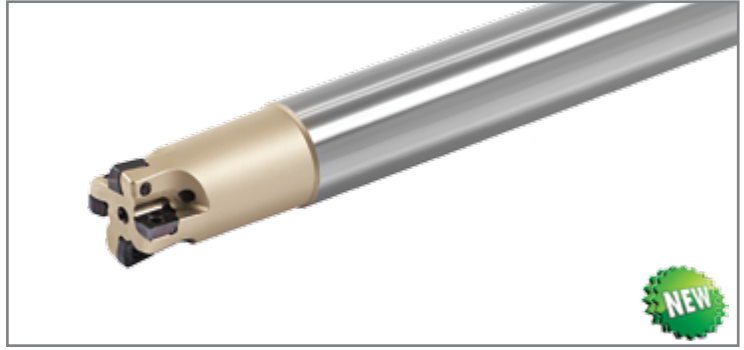
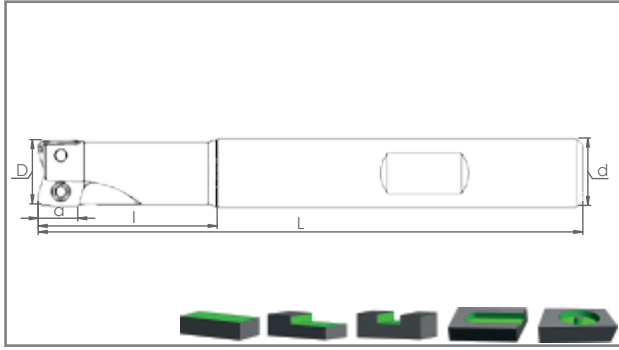

## DEĞİŞKEN UCLU FREZELER

### End Mills with changeable insert



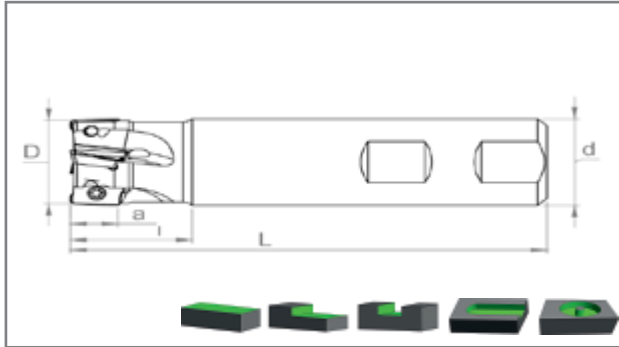



KOD CODE	ÖLÇÜLER DIMENSION (mm)						KESİCİ UÇ INSERT	YEDEK PARÇALAR SPARE PARTS	
	D	d	Z	L	l	a		Sıkma Vidası Clamp Screw	Anahtar Torx Key
<b>ST90 AXMT 0602..</b>									
ST90 AX06 D10 W10 L120 Z02-H	10	10	2	120	30	5.75	AXMT 0602.. TGTC UCA UYGUNDUR FOR TGTC INSERT	SSV M1.8x4 9501	T06
ST90 AX06 D12 W12 L120 Z02-H	12	12	2	120	30	5.75			
ST90 AX06 D16 W16 L120 Z04-H	16	16	4	120	30	5.75			



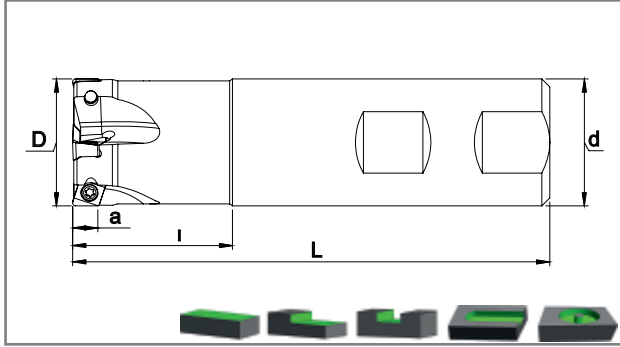



KOD CODE	ÖLÇÜLER DIMENSION (mm)						KESİCİ UÇ INSERT	YEDEK PARÇALAR SPARE PARTS				
	D	d	Z	L	l	a		Sıkma Vidası Clamp Screw	Anahtar Torx Key			
<b>ST90 AXMT 1235 / 1705..</b>												
ST90 AX12 D16 W16 L120 Z02	16	16	2	120	30	10	AXMT 1235.. SMTM UCA UYGUNDUR FOR SMTM INSERT	SSV M3x5 LG-9525	T08			
ST90 AX12 D20 W20 L110 Z03-H	20	20	3	110	30	10						
ST90 AX12 D20 W20 L120 Z03	20	20	3	120	30	10						
ST90 AX12 D20 W20 L120 Z03-H	20	20	3	120	30	10						
ST90 AX12 D25 C20 L120 Z03	25	20	3	120	30	10						
ST90 AX12 D25 W25 L120 Z04	25	25	4	120	30	10						
ST90 AX12 D16 W16 L150 Z02	16	16	2	150	40	10						
ST90 AX12 D20 W20 L150 Z03	20	20	3	150	40	10						
ST90 AX12 D25 W25 L150 Z04	25	25	4	150	40	10						
ST90 AX12 D16 C16 L200 Z02	16	16	2	200	50	10						
<b>ST90 AX12 D20 C20 L200 Z03</b>	20	20	3	200	50	10						
ST90 AX12 D25 C25 L200 Z04	25	25	4	200	50	10						
ST90 AX17 D32 W32 L120 Z03	32	32	3	120	30	14				AXMT 1705.. SMTM UCA UYGUNDUR FOR SMTM INSERT	SSV M4x10 9514	T15
ST90 AX17 D32 W32 L120 Z03-H	32	32	3	120	30	14						
ST90 AX17 D25 W25 L150 Z02	25	25	2	150	40	14						
ST90 AX17 D32 W32 L150 Z03	32	32	3	150	40	14						
ST90 AX17 D40 W32 L150 Z04	40	32	4	150	25	14						
ST90 AX17 D32 C32 L200 Z03	32	32	3	200	50	14						
ST90 AX17 D40 C32 L200 Z04	40	32	4	200	25	14						
ST90 AX17 D32 C32 L250 Z03	32	32	3	250	50	14						

## DEĞİŞKEN UCLU FREZELER End Mills with changeable insert

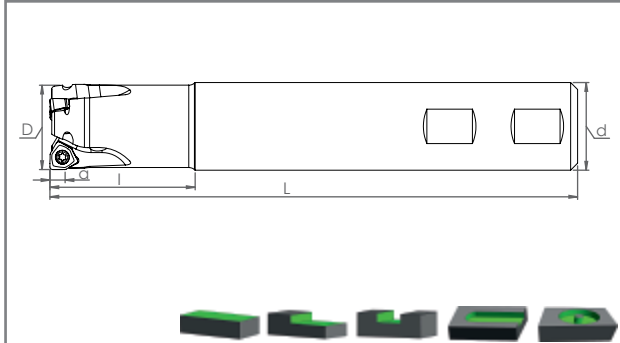

KOD CODE	ÖLÇÜLER DIMENSION (mm)						KESİCİ UÇ INSERT	YEDEK PARÇALAR SPARE PARTS	
	D	d	Z	L	I	a		Sıkma Vidası Clamp Screw	Anahtar Torx Key
<b>ST90 4NKT 0603..</b>									
ST90 4N06 D16 W16 L120 Z02-H	16	16	2	120	30	6	4NKT 0603 TGTC UCA UYGUNDUR FOR TGTC INSERT	SSV M3x6 LG 9525	T08
ST90 4N06 D20 W20 L120 Z03-H	20	20	3	120	30	6			
ST90 4N06 D16 W16 L150 Z02	16	16	2	150	40	6			
ST90 4N06 D20 W20 L150 Z03	20	20	3	150	40	6			
ST90 4N06 D25 W25 L150 Z03	25	25	3	150	40	6			
ST90 4N06 D32 W32 L150 Z04	32	32	4	150	40	6			



KOD CODE	ÖLÇÜLER DIMENSION (mm)						KESİCİ UÇ INSERT	YEDEK PARÇALAR SPARE PARTS	
	D	d	Z	L	I	a		Sıkma Vidası Clamp Screw	Anahtar Torx Key
<b>ST90 6NKU 0403..</b>									
ST90 6N04 D20 W20 L150 Z02-H	20	20	2	150	40	4.1	6NKU 0403.. TGTC UCA UYGUNDUR FOR TGTC INSERT	SSV M2.5x6-9505 SSV M2.5x7 9506	T08
ST90 6N04 D25 W25 L150 Z03-H	25	25	3	150	40	4.1			
ST90 6N04 D32 W32 L150 Z04-H	32	32	4	150	40	4.1			

## DEĞİŞKEN UCLU FREZELER

End Mills with changeable insert

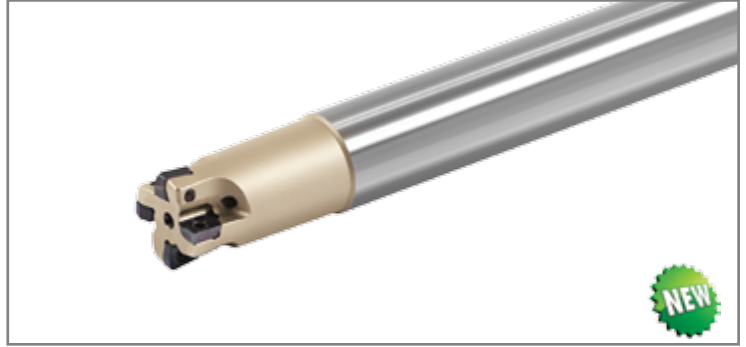
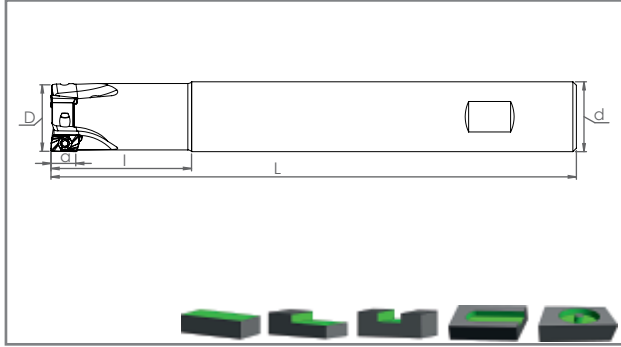

KOD CODE	ÖLÇÜLER DIMENSION (mm)						KESİCİ UÇ INSERT	YEDEK PARÇALAR SPARE PARTS	
	D	d	Z	L	l	a		Sıkma Vidası Clamp Screw	Anahtar Torx Key
<b>ST90 AOMT 0702..</b>									
ST90 AO07 D12 W12 L120 Z02-H	12	12	2	120	30	7	AOMT 0702.. TNGLY UCA UYGUNDUR FOR TNGLY INSERT	SSV M2.2x5 9503	T06
ST90 AO07 D16 W16 L120 Z03-H	16	16	3	120	30	7			
ST90 AO07 D20 W20 L150 Z04-H	20	20	4	150	40	7			
ST90 AO07 D22 W20 L150 Z04-H	22	20	4	150	25	7			

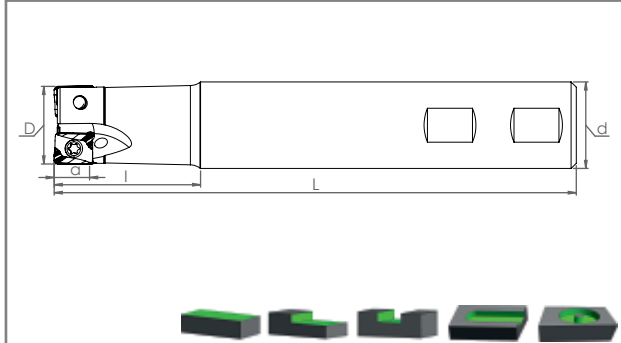





KOD CODE	ÖLÇÜLER DIMENSION (mm)						KESİCİ UÇ INSERT	YEDEK PARÇALAR SPARE PARTS	
	D	d	Z	L	l	a		Sıkma Vidası Clamp Screw	Anahtar Torx Key
<b>ST90 LQMU 1107..</b>									
ST90 LQ11 D25 W25 L150 Z02-H	25	25	2	150	40	9	LQMU 1107.. TNGLY UCA UYGUNDUR FOR TNGLY INSERT	SSV M3.5x8 SC-9513	T10
ST90 LQ11 D32 W32 L150 Z03-H	32	32	3	150	40	9			



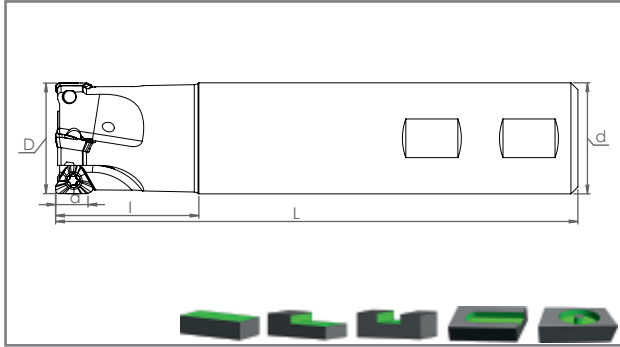



## DEĞİŞKEN UCLU FREZELER

End Mills with changeable insert

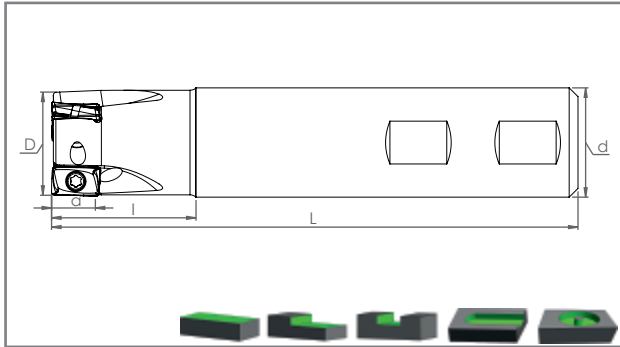

KOD CODE	ÖLÇÜLER DIMENSION (mm)						KESİCİ UÇ INSERT	YEDEK PARÇALAR SPARE PARTS	
	D	d	Z	L	I	a		Sıkma Vidası Clamp Screw	Anahtar Torx Key
<b>ST90 TOMT 0603 / 1004..</b>									
ST90 TO06 D16 W16 L150 Z02-H	16	16	2	150	40	6	TOMT 0603.. TNGLY UCA UYGUNDUR FOR TGTC INSERT	SSV M2.5x5-9504	T08
ST90 TO06 D20 W20 L150 Z03-H	20	20	3	150	40	6			
ST90 TO06 D25 W25 L150 Z04-H	25	25	4	150	40	6			
ST90 TO10 D25 W25 L150 Z02-H	25	25	2	150	40	10	TOMT 1004.. TNGLY UCA UYGUNDUR FOR TGTC INSERT	SSV M3.5x8 SC-9513	T10
ST90 TO10 D32 W32 L150 Z03-H	32	32	3	150	40	10			





KOD CODE	ÖLÇÜLER DIMENSION (mm)						KESİCİ UÇ INSERT	YEDEK PARÇALAR SPARE PARTS	
	D	d	Z	L	I	a		Sıkma Vidası Clamp Screw	Anahtar Torx Key
<b>ST90 LOMU 1004..</b>									
ST90 LM10 D16 W16 L120 Z02-H	16	16	2	120	30	10	LOMU 1004.. KYCR UCA UYGUNDUR FOR KYCR INSERT	SSV M3x6 LG 9509	T08
ST90 LM10 D20 W20 L120 Z03-H	20	20	3	120	30	10			
ST90 LM10 D25 W25 L120 Z03-H	25	25	3	120	30	10			
ST90 LM10 D32 W32 L120 Z04-H	32	32	4	120	30	10			
ST90 LM10 D16 W16 L150 Z02-H	16	16	2	150	40	10			
ST90 LM10 D20 W20 L150 Z03-H	20	20	3	150	40	10			
ST90 LM10 D25 W25 L150 Z03-H	25	25	3	150	40	10			
ST90 LM10 D32 W32 L150 Z04-H	32	32	4	150	40	10			

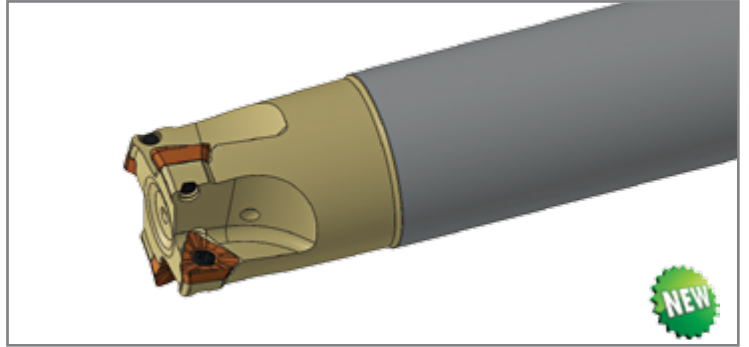
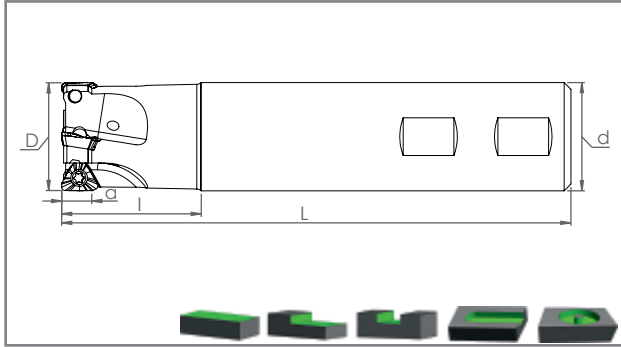

## DEĞİŞKEN UCLU FREZELER

### End Mills with changeable insert

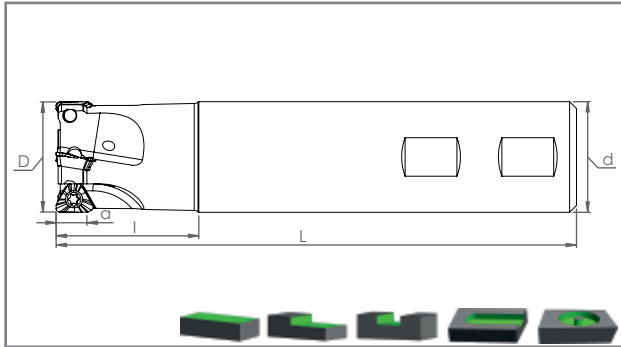

KOD CODE	ÖLÇÜLER DIMENSION (mm)						KESİCİ UÇ INSERT	YEDEK PARÇALAR SPARE PARTS	
	D	d	Z	L	l	a		Sıkma Vidası Clamp Screw	Anahtar Torx Key
<b>ST90 TP.. 1003..</b>									
ST90 TP10 D25 W25 L150 Z02-H	25	25	2	150	40	8	<b>TP.. 1003.. ISCR UCA UYGUNDUR FOR ISCR INSERT</b>	<b>SSV M3.5x8 SC-9513</b>	<b>T10</b>
ST90 TP10 D28 W25 L150 Z03-H	28	25	3	150	40	8			
ST90 TP10 D32 W32 L150 Z04-H	32	32	4	150	40	8			





KOD CODE	ÖLÇÜLER DIMENSION (mm)						KESİCİ UÇ INSERT	YEDEK PARÇALAR SPARE PARTS	
	D	d	Z	L	l	a		Sıkma Vidası Clamp Screw	Anahtar Torx Key
<b>ST90 TN.X 1005..</b>									
ST90 TN1005 D20 W20 L150 Z02-H	20	20	2	150	40	5	<b>TN.X 1005.. ISCR UCA UYGUNDUR FOR ISCR INSERT</b>	<b>SSV M3x6 LG 9509</b>	<b>T08</b>
ST90 TN1005 D25 W25 L150 Z03-H	25	25	3	150	40	5			
ST90 TN1005 D32 W32 L150 Z04-H	32	32	4	150	40	5			

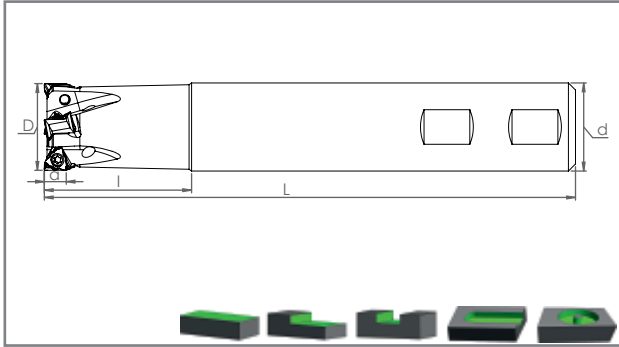

## DEĞİŞKEN UCLU FREZELER

End Mills with changeable insert

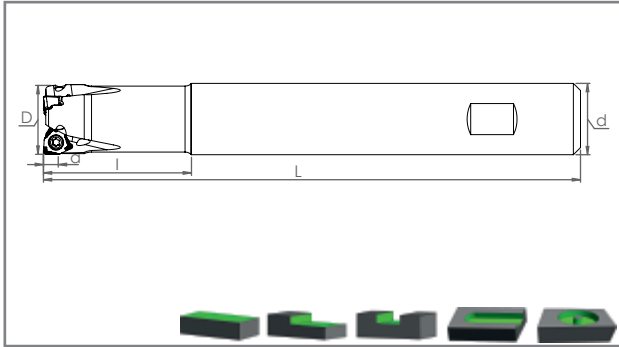

KOD CODE	ÖLÇÜLER DIMENSION (mm)						KESİCİ UÇ INSERT	YEDEK PARÇALAR SPARE PARTS	
	D	d	Z	L	l	a		Sıkma Vidası Clamp Screw	Anahtar Torx Key
<b>ST90 TNGX 1004..</b>									
ST90 TNGX10 D20 W20 L150 Z03-H	20	20	3	150	40	5	TNGX 1004.. PRMT UCA UYGUNDUR FOR PRMT INSERT	SSV M2.5x6-9505	T08
ST90 TNGX10 D25 W25 L150 Z04-H	25	25	4	150	40	5		SSV M2.5x7-9506	
ST90 TNGX10 D32 W32 L150 Z04-H	32	32	4	150	40	5			



KOD CODE	ÖLÇÜLER DIMENSION (mm)						KESİCİ UÇ INSERT	YEDEK PARÇALAR SPARE PARTS	
	D	d	Z	L	l	a		Sıkma Vidası Clamp Screw	Anahtar Torx Key
<b>ST90 XNEX 0403..</b>									
ST90 XN04 D17 W16 L150 Z02-H	17	16	2	150	25	4	XNEX 0403.. SECO UCA UYGUNDUR FOR SECO INSERT	SSV M2.5x6-9505	T08
ST90 XN04 D20 W20 L150 Z03-H	20	20	3	150	40	4			
ST90 XN04 D25 W25 L150 Z04-H	25	25	4	150	40	4		SSV M2.5x7-9506	
ST90 XN04 D32 W32 L150 Z05-H	32	32	5	150	40	4			

## DEĞİŞKEN UCLU FREZELER

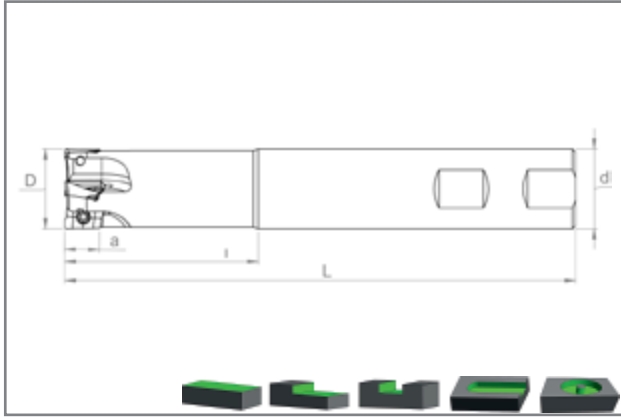

### End Mills with changeable insert





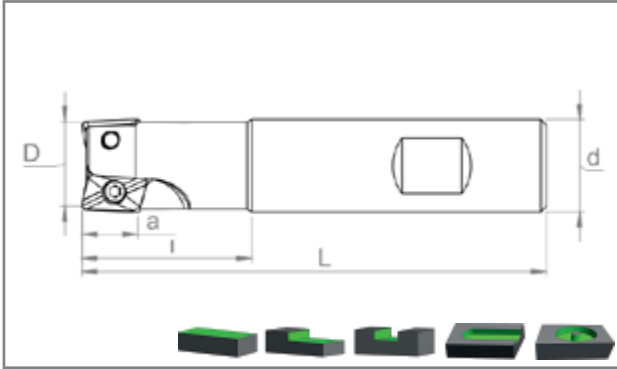

KOD CODE	ÖLÇÜLER DIMENSION (mm)						KESİCİ UÇ INSERT	YEDEK PARÇALAR SPARE PARTS	
	D	d	Z	L	I	a		Sıkma Vidası Clamp Screw	Anahtar Torx Key
<b>ST90 BDMT 0703 / 1103 / 1704..</b>									
ST90 BD07 D10 C10 L100 Z01	10	10	1	100	30	6	<b>BDMT 0703.. KYCR UCA UYGUNDUR FOR KYCR INSERT</b>	<b>SSV M2x4 9521</b>	T06
<a href="#">ST90 BD07 D10 C10 L100 Z01-H</a>	10	10	1	100	30	6			
ST90 BD07 D12 C12 L120 Z02	12	12	2	120	30	6			
<a href="#">ST90 BD07 D12 C12 L120 Z02-H</a>	12	12	2	120	30	6	<b>BDMT 1103.. KYCR UCA UYGUNDUR FOR KYCR INSERT</b>	<b>SSV M2.5x5 9504</b>	T08
ST90 BD11 D16 W16 L150 Z02	16	16	2	150	40	10			
<a href="#">ST90 BD11 D16 W16 L150 Z02-H</a>	16	16	2	150	40	10			
<a href="#">ST90 BD11 D17 W16 L150 Z02-H</a>	17	16	2	150	25	10			
ST90 BD11 D20 W20 L150 Z03	20	20	3	150	40	10			
<a href="#">ST90 BD11 D20 W20 L150 Z03-H</a>	20	20	3	150	40	10			
<a href="#">ST90 BD11 D21 W20 L150 Z03-H</a>	21	20	3	150	25	10			
ST90 BD11 D25 W25 L150 Z04	25	25	4	150	40	10			
<a href="#">ST90 BD11 D25 W25 L150 Z04-H</a>	25	25	4	150	40	10			
<a href="#">ST90 BD11 D26 W25 L150 Z04-H</a>	26	25	4	150	25	10			
<a href="#">ST90 BD11 D32 W32 L150 Z05-H</a>	32	32	5	150	40	10			
ST90 BD11 D17 C16 L200 Z02	17	16	2	200	25	10			
ST90 BD11 D21 C20 L200 Z03	21	20	3	200	25	10			
ST90 BD11 D26 C25 L200 Z04	26	25	4	200	25	10			
ST90 BD17 D25 W25 L150 Z02	25	25	2	150	40	16	<b>BDMT 1704.. KYCR UCA UYGUNDUR FOR KYCR INSERT</b>	<b>SSV M4x10 9514</b>	T15
<a href="#">ST90 BD17 D25 W25 L150 Z02-H</a>	25	25	2	150	40	16			
ST90 BD17 D32 W32 L150 Z03	32	32	3	150	40	16			
ST90 BD17 D25 C25 L200 Z02	25	25	2	200	50	16			
ST90 BD17 D32 C32 L200 Z03	32	32	3	200	50	16			

## DEĞİŞKEN UCLU FREZELER End Mills with changeable insert

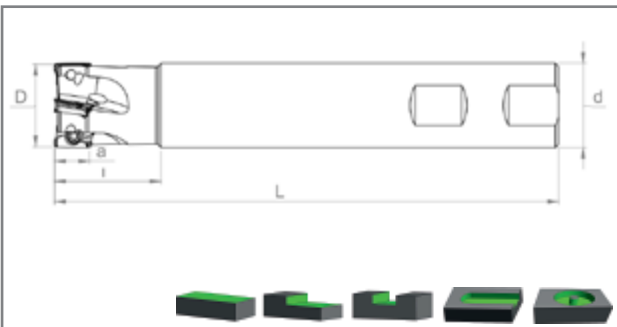

KOD CODE	ÖLÇÜLER DIMENSION (mm)						KESİCİ UÇ INSERT	YEDEK PARÇALAR SPARE PARTS	
	D	d	Z	L	l	a		Sıkma Vidası Clamp Screw	Anahtar Torx Key
<b>ST90 XOMX 0602 / 10T3 / 1204..</b>									
ST90 XO06 D10 C10 L120 Z02	10	10	2	120	30	5.5	<b>XOMX 0602.. SECO UCA UYGUNDUR FOR SECO INSERT</b>	<b>SSV M1.8X4 9501</b>	T06
ST90 XO06 D12 C12 L120 Z02	12	12	2	120	30	5.5			
<b>ST90 XO06 D16 W16 L120 Z03-H</b>	16	16	3	120	30	3			
<b>ST90 XO06 D20 W20 L120 Z04-H</b>	20	20	4	120	30	3	<b>XOMX 10T3.. SECO UCA UYGUNDUR FOR SECO INSERT</b>	<b>SSV M2.5x5 9504 SSV M2.5x6 9505 SSV M2.5x5 9504 SSV M2.5x6 9505</b>	T08
ST90 XO10 D16 W16 L120 Z02	16	16	2	120	30	9			
<b>ST90 XO10 D16 W16 L120 Z02-H</b>	16	16	2	120	30	9			
ST90 XO10 D20 W20 L120 Z03	20	20	3	120	30	9			
<b>ST90 XO10 D20 W20 L120 Z03-H</b>	20	20	3	120	30	9			
<b>ST90 XO10 D16 W16 L150 Z02-H</b>	16	16	2	150	40	9			
<b>ST90 XO10 D20 W20 L150 Z03-H</b>	20	20	3	150	40	9			
ST90 XO10 D20 C20 L200 Z03	20	20	3	200	50	9			
<b>ST90 XO12 D20 W20 L120 Z02-H</b>	20	20	2	120	30	11			
<b>ST90 XO12 D20 W20 L150 Z02-H</b>	20	20	2	150	40	11			
<b>ST90 XO12 D25 W25 L150 Z03-H</b>	25	25	3	150	40	11	<b>XOMX 1204.. SECO UCA UYGUNDUR FOR SECO INSERT</b>	<b>SSV M3.5x8 SC 9513</b>	T10
<b>ST90 XO12 D32 W32 L150 Z04-H</b>	32	32	4	150	40	11			
ST90 XO12 D20 C20 L200 Z02	20	20	2	200	50	11			
ST90 XO12 D25 C25 L200 Z03	25	25	3	200	50	11			
ST90 XO12 D32 C32 L200 Z04	32	32	4	200	50	11			



KOD CODE	ÖLÇÜLER DIMENSION (mm)						KESİCİ UÇ INSERT	YEDEK PARÇALAR SPARE PARTS	
	D	d	Z	L	l	a		Sıkma Vidası Clamp Screw	Anahtar Torx Key
<b>ST90 AOMT 1236..</b>									
<b>ST90 AO12 D16 W16 L150 Z02-H</b>	16	16	2	150	40	12	<b>AOMT 1236.. MTSBSH UCA UYGUNDUR FOR MTSBSH INSERT</b>	<b>SSV M2.5x5-9504 SSV M2.5x6-9505</b>	T08
<b>ST90 AO12 D20 W20 L150 Z03-H</b>	20	20	3	150	40	12			
<b>ST90 AO12 D22 W20 L150 Z03-H</b>	22	20	3	150	25	12			
<b>ST90 AO12 D25 W25 L150 Z04-H</b>	25	25	4	150	40	12			
<b>ST90 AO12 D32 W32 L150 Z05-H</b>	32	32	5	150	40	12			

H-IÇTEN SU VERMELİ  
H-WITH COOLANT HOLE

## DEĞİŞKEN UCLU FREZELER

End Mills with changeable insert

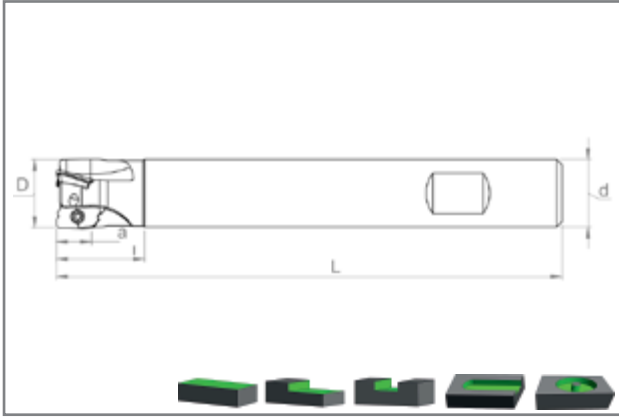

KOD CODE	ÖLÇÜLER DIMENSION (mm)						KESİCİ UÇ INSERT	YEDEK PARÇALAR SPARE PARTS	
	D	d	Z	L	l	a		Sıkma Vidası Clamp Screw	Anahtar Torx Key
<b>ST90 XDKT 0703 / 11T3..</b>									
ST90 XD07 D12 C10 L120 Z02	12	10	2	120	30	07	<b>XDKT 0703.. CRTZT UCA UYGUNDUR FOR CRTZT INSERT</b>		T07
ST90 XD07 D12 C12 L120 Z02	12	12	2	120	30	07			
ST90 XD07 D16 W16 L150 Z03-H	16	16	3	150	40	07			
ST90 XD07 D17 W16 L150 Z03-H	17	16	2	150	25	07			
ST90 XD07 D16 C16 L200 Z03	16	16	3	200	50	07	<b>XDKT 11T3.. CRTZT UCA UYGUNDUR FOR CRTZT INSERT</b>		T08
ST90 XD11 D16 W16 L150 Z02-H	16	16	2	150	40	11			
ST90 XD11 D17 W16 L150 Z02-H	17	16	2	150	25	11			
ST90 XD11 D20 W20 L150 Z03-H	20	20	3	150	40	11			
ST90 XD11 D21 W20 L150 Z03-H	21	20	3	150	25	11			
ST90 XD11 D25 W25 L150 Z03-H	25	25	3	150	40	11			
ST90 XD11 D26 W25 L150 Z03-H	26	25	3	150	25	11			
ST90 XD11 D16 C16 L200 Z02	16	16	2	200	50	11			
ST90 XD11 D17 C16 L200 Z02	17	16	2	200	25	11			
ST90 XD11 D20 C20 L200 Z03	20	20	3	200	50	11			
ST90 XD11 D21 C20 L200 Z03	21	20	3	200	25	11			
ST90 XD11 D25 C25 L200 Z04	25	25	4	200	50	11			
ST90 XD11 D26 C25 L200 Z04	26	25	4	200	25	11			

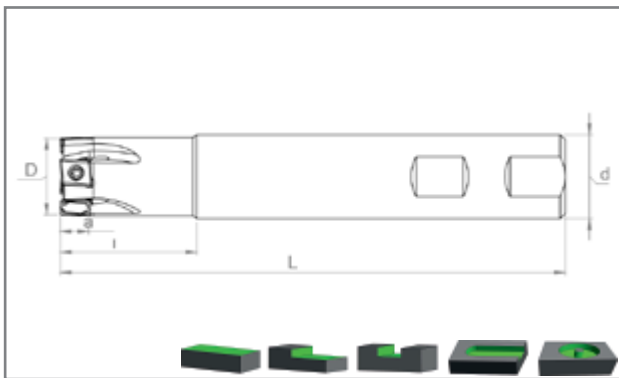







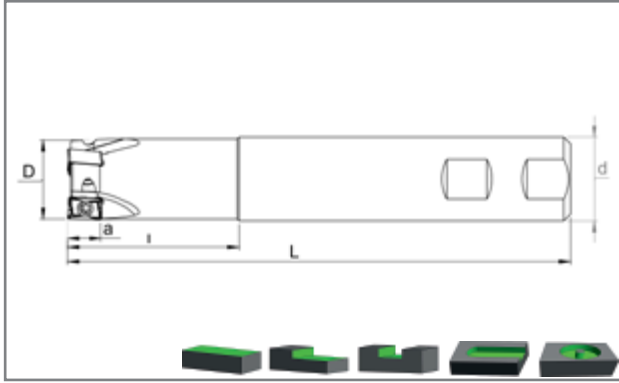

KOD CODE	ÖLÇÜLER DIMENSION (mm)						KESİCİ UÇ INSERT	YEDEK PARÇALAR SPARE PARTS	
	D	d	Z	L	l	a		Sıkma Vidası Clamp Screw	Anahtar Torx Key
<b>ST90 LNHU 0904..</b>									
ST90 LN09 D20 W20 L150 Z03-H	20	20	3	150	40	9	<b>LNHU 0904.. WLTR UCA UYGUNDUR FOR WLTR INSERT</b>		T08
ST90 LN09 D25 W25 L150 Z04-H	25	25	4	150	40	9			
ST90 LN09 D32 W32 L150 Z05-H	32	32	5	150	40	9			

H-İÇTEN SU VERMELİ  
H-WITH COOLANT HOLE

## DEĞİŞKEN UCLU FREZELER

End Mills with changeable insert



KOD CODE	ÖLÇÜLER DIMENSION (mm)						KESİCİ UÇ INSERT	YEDEK PARÇALAR SPARE PARTS	
	D	d	Z	L	l	a		Sıkma Vidası Clamp Screw	Anahtar Torx Key
<b>ST90 LN.X 1006 / 1510..</b>									
ST90 LN10 D16 W16 L120 Z01	16	16	1	120	30	9	<b>LN.X 1006.. KRLY UCA UYGUNDUR FOR KRLY INSERT</b>	<b>SSV M3x8 9508</b>	<b>T08</b>
<b>ST90 LN10 D16 W16 L120 Z01-H</b> 	16	16	1	120	30	9			
ST90 LN10 D18 W16 L120 Z02	18	16	2	120	25	9			
ST90 LN10 D20 W20 L150 Z02	20	20	2	150	40	9			
<b>ST90 LN10 D20 W20 L150 Z02-H</b> 	20	20	2	150	40	9			
ST90 LN10 D22 W20 L150 Z02	22	20	2	150	25	9			
ST90 LN10 D25 W25 L150 Z03	25	25	3	150	40	9			
<b>ST90 LN10 D25 W25 L150 Z03-H</b> 	25	25	3	150	40	9			
ST90 LN10 D32 W32 L150 Z04	32	32	4	150	40	9			
ST90 LN10 D40 W32 L150 Z05	40	32	5	150	25	9			
ST90 LN15 D32 W32 L150 Z02	32	32	2	150	40	14	<b>LN.X 1510.. KRLY UCA UYGUNDUR FOR KRLY INSERT</b>	<b>SSV M4x14 9516</b>	<b>T15</b>
<b>ST90 LN15 D32 W32 L150 Z02-H</b> 	32	32	2	150	40	14			
ST90 LN15 D35 W32 L150 Z03	35	32	3	150	25	14			
ST90 LN15 D40 W32 L150 Z03	40	32	3	150	25	14			
<b>ST90 LN15 D40 W32 L150 Z03-H</b> 	40	32	3	150	25	14			
ST90 LN15 D32 C32 L250 Z02	32	32	2	250	180	14			
ST90 LN15 D35 C32 L250 Z03	35	32	3	250	30	14			
ST90 LN15 D40 C32 L250 Z03	40	32	3	250	30	14			
ST90 LN15 D32 C32 L300 Z02	32	32	2	300	230	14			
ST90 LN15 D35 C32 L300 Z03	35	32	3	300	30	14			
ST90 LN15 D40 C32 L300 Z03	40	32	3	300	30	14			

## DEĞİŞKEN UCLU FREZELER

End Mills with changeable insert

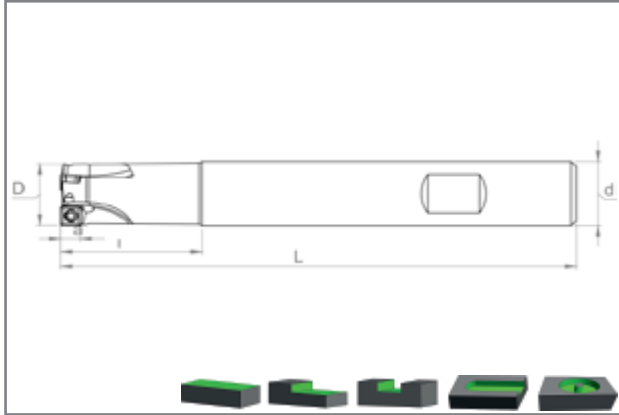

KOD CODE	ÖLÇÜLER DIMENSION (mm)						KESİCİ UÇ INSERT	YEDEK PARÇALAR SPARE PARTS	
	D	d	Z	L	I	a		Sıkma Vidası Clamp Screw	Anahtar Torx Key
<b>ST90 SPMG 0602 / 07T3 / 0904..</b>									
ST90 SP06 D17 W16 L150 Z02	17	16	2	150	25	6	SPMG 060204 TGTC UCA UYGUNDUR FOR TGTC INSERT	SSV M2.2x5-9503	T07
ST90 SP06 D20 W20 L150 Z03	20	20	3	150	40	6			
ST90 SP07 D22 W20 L150 Z03	22	20	3	150	25	7	SPMG 07T308 TGTC UCA UYGUNDUR FOR TGTC INSERT	SSV M2.5x6-9505	T08
ST90 SP07 D25 W25 L150 Z03	25	25	3	150	40	7			
ST90 SP07 D26 W25 L150 Z03	26	25	3	150	25	7	SPMG 090408 TGTC UCA UYGUNDUR FOR TGTC INSERT	SSV M3.5x8-9510	T15
ST90 SP09 D32 W32 L150 Z03	32	32	3	150	40	9			
ST90 SP09 D33 W32 L150 Z03	33	32	3	150	25	9			

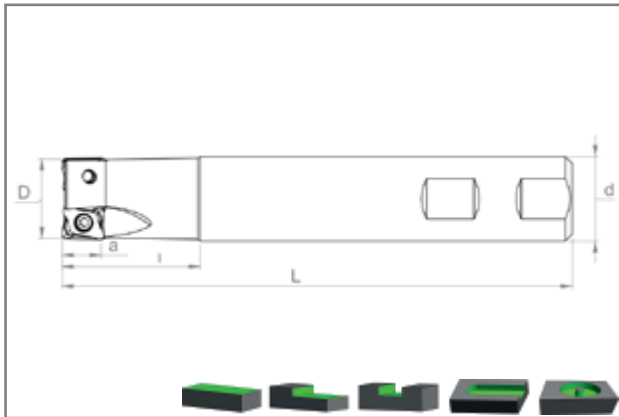





KOD CODE	ÖLÇÜLER DIMENSION (mm)						KESİCİ UÇ INSERT	YEDEK PARÇALAR SPARE PARTS	
	D	d	Z	L	I	a		Sıkma Vidası Clamp Screw	Anahtar Torx Key
<b>ST90 LNGX 1205..</b>									
ST90 LN12 D25 W25 L150 Z02	25	25	2	150	40	11	LNGX 1205.. PRMT UCA UYGUNDUR FOR PRMT INSERT	SSV M3.5x8-9510	T15
ST90 LN12 D32 W32 L150 Z03	32	32	3	150	40	11			



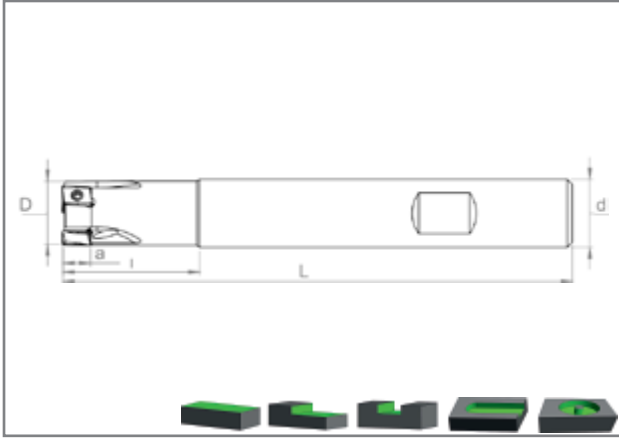



## DEĞİŞKEN UCLU FREZELER

End Mills with changeable insert

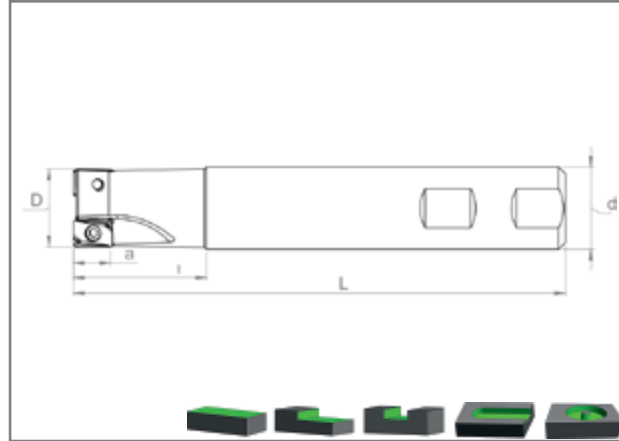

KOD CODE	ÖLÇÜLER DIMENSION (mm)						KESİCİ UÇ INSERT	YEDEK PARÇALAR SPARE PARTS	
	D	d	Z	L	l	a		Sıkma Vidası Clamp Screw	Anahtar Torx Key
<b>ST90 LNMT 0804..</b>									
ST90 LN08 D16 W16 L150 Z02-H	16	16	2	150	40	8	LNMT 0804.. ISCR UCA UYGUNDUR FOR ISCR INSERT	SSV M2.5x6- <b>9505</b>	T08
ST90 LN08 D20 W20 L150 Z03-H	20	20	3	150	40	8			
ST90 LN08 D25 W25 L150 Z04-H	25	25	4	150	40	8			
ST90 LN08 D30 W25 L150 Z04-H	30	25	4	150	25	8			
ST90 LN08 D32 W32 L150 Z05-H	32	32	5	150	40	8			



KOD CODE	ÖLÇÜLER DIMENSION (mm)						KESİCİ UÇ INSERT	YEDEK PARÇALAR SPARE PARTS	
	D	d	Z	L	l	a		Sıkma Vidası Clamp Screw	Anahtar Torx Key
<b>ST90 ANGX 1105..</b>									
ST90 AN11 D25 W25 L150 Z02-H	25	25	2	150	40	10	ANGX 1105.. ZCC-CT UCA UYGUNDUR FOR ZCC-CT INSERT	SSV M3x8 <b>9508</b>	T08
ST90 AN11 D32 W32 L150 Z03-H	32	32	3	150	40	10			

## DEĞİŞKEN UCLU FREZELER

### End Mills with changeable insert

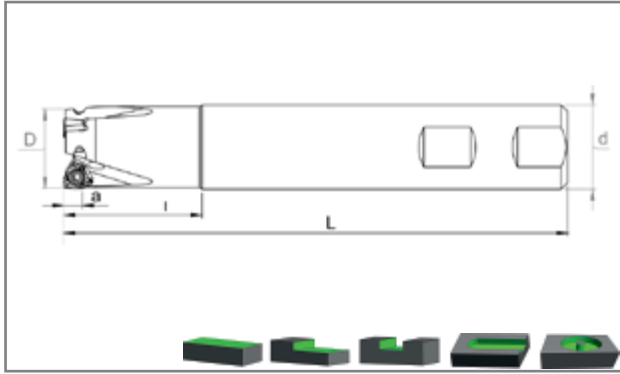

KOD CODE	ÖLÇÜLER DIMENSION (mm)						KESİCİ UÇ INSERT	YEDEK PARÇALAR SPARE PARTS	
	D	d	Z	L	l	a		Sıkma Vidası Clamp Screw	Anahtar Torx Key
<b>ST90 XNKT 0604 / 0805..</b>									
ST90 XNKT06 D20 W20 L150 Z02-H	20	20	2	150	40	6	<b>XNKT 0604.. KRLY UCA UYGUNDUR FOR KRLY INSERT</b>	<b>SSV M3x6 9507</b>	T08
ST90 XNKT06 D21 W20 L150 Z02-H	21	20	2	150	25	6			
ST90 XNKT06 D22 W20 L150 Z02-H	22	20	2	150	25	6			
ST90 XNKT06 D25 W25 L150 Z03-H	25	25	3	150	40	6			
ST90 XNKT06 D26 W25 L150 Z03-H	26	25	3	150	25	6		<b>SSV M3x8 9508</b>	
ST90 XNKT06 D32 W32 L150 Z04-H	32	32	4	150	40	6			
ST90 XNKT06 D33 W32 L150 Z04-H	33	32	4	150	25	6			
ST90 XNKT06 D21 C20 L200 Z02	21	20	2	200	25	6		<b>SSV M3x6-9507</b>	T08
ST90 XNKT06 D26 C25 L200 Z03	26	25	3	200	25	6	<b>SSV M3x8 9508</b>		
ST90 XNKT06 D33 C32 L200 Z04	33	32	4	200	25	6			
ST90 XNKT08 D30 W25 L150 Z02 <b>NEW</b>	30	25	2	150	25	8	<b>XNKT 0805.. KRLY UCA UYGUNDUR FOR KRLY INSERT</b>	<b>SSV M4x10 9514</b>	
ST90 XNKT08 D32 W32 L150 Z02	32	32	2	150	40	8			
ST90 XNKT08 D35 W32 L150 Z03 <b>NEW</b>	35	32	3	150	25	8			
ST90 XNKT08 D40 W32 L150 Z04	40	32	4	150	25	8			

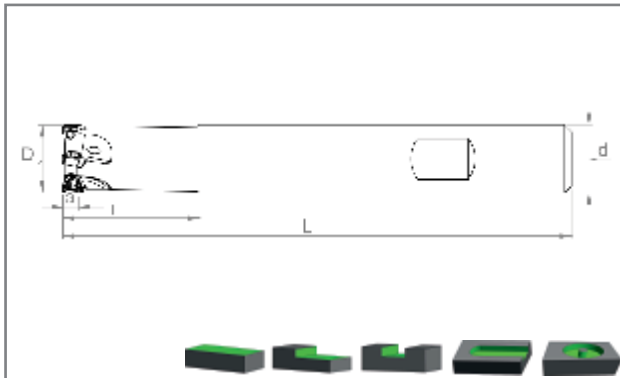



KOD CODE	ÖLÇÜLER DIMENSION (mm)						KESİCİ UÇ INSERT	YEDEK PARÇALAR SPARE PARTS	
	D	d	Z	L	l	a		Sıkma Vidası Clamp Screw	Anahtar Torx Key
<b>ST90 3PKT 0603 / 1004..</b>									
ST90 3PK06 D12 W12 L150 Z01-H	12	12	1	150	40	5	<b>3PKT 0603.. TGTC UCA UYGUNDUR FOR TGTC INSERT</b>	<b>SSV M2x5 9502</b>	T06
ST90 3PK06 D16 W16 L150 Z03-H	16	16	3	150	40	5			
ST90 3PK06 D20 W20 L150 Z04-H	20	20	4	150	40	5		<b>SSV M2x5-9502</b>	
ST90 3PK10 D16 W16 L150 Z01-H	16	16	1	150	40	9	<b>3P.T 1004.. TGTC UCA UYGUNDUR FOR TGTC INSERT</b>	<b>SSV M3x5-9524</b>	T08
ST90 3PK10 D20 W20 L150 Z02-H	20	20	2	150	40	9			
ST90 3PK10 D25 W25 L150 Z03-H	25	25	3	150	40	9		<b>SSV M3x6-9507</b>	
ST90 3PK10 D32 W32 L150 Z04-H	32	32	4	150	40	9			

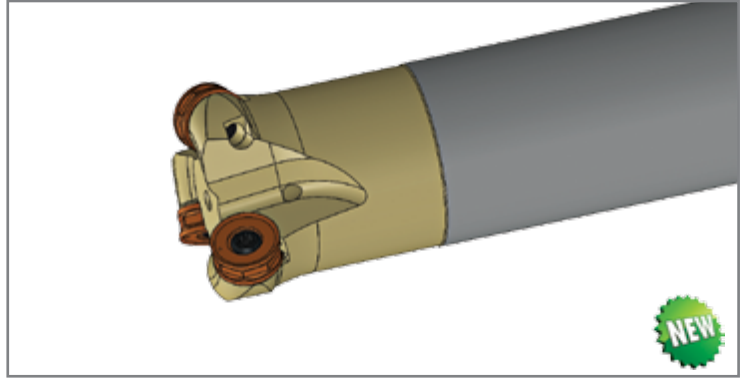
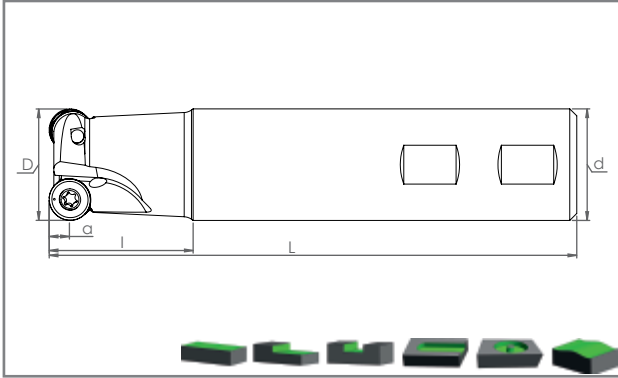

H-İÇTEN SU VERMELİ  
H-WITH COOLANT HOLE

## DEĞİŞKEN UCLU FREZELER End Mills with changeable insert

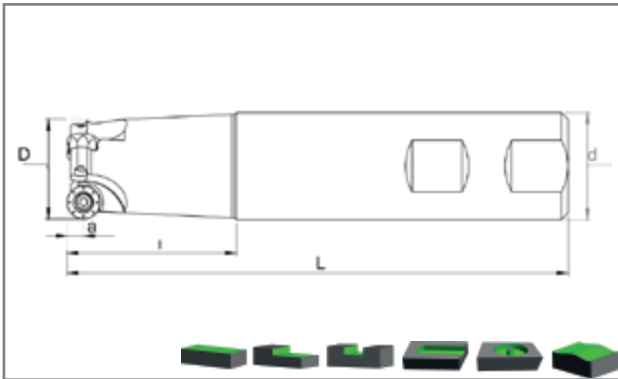

KOD CODE	ÖLÇÜLER DIMENSION (mm)						KESİCİ UÇ INSERT	YEDEK PARÇALAR SPARE PARTS	
	D	d	Z	L	l	a		Sıkma Vidası Clamp Screw	Anahtar Torx Key
<b>ST RNMU 1004 / 1205..</b>									
ST RN10 D25 W25 L150 Z02-H	25	25	2	150	40	5	RNMU 1003.. TGTC UCA UYGUNDUR FOR TGTC INSERT	SSV M3.5x10 9511	T15
ST RN10 D32 W32 L150 Z03-H	32	32	3	150	40	5			
ST RN12 D32 W32 L150 Z02-H	32	32	2	150	40	6	RNMU 1205.. TGTC UCA UYGUNDUR FOR TGTC INSERT	SSV M4x10 9514	
ST RN12 D40 W32 L150 Z03-H	40	32	3	150	25	6			



KOD CODE	ÖLÇÜLER DIMENSION (mm)						KESİCİ UÇ INSERT	YEDEK PARÇALAR SPARE PARTS	
	D	d	Z	L	l	a		Sıkma Vidası Clamp Screw	Anahtar Torx Key
<b>ST QPMT 10T3 / 1204..</b>									
ST QP10 D25 W25 L150 Z02	25	25	2	150	40	5	QPMT 10T3.. SMTM UCA UYGUNDUR FOR SMTM INSERT	SSV M3.5x8 9510	T15
ST QP10 D32 W32 L150 Z03	32	32	3	150	40	5			
ST QP10 D25 C25 L200 Z02	25	25	2	200	50	5	QPMT 1204.. SMTM UCA UYGUNDUR FOR SMTM INSERT	SSV M4x10-9514	
ST QP10 D32 C32 L200 Z03	32	32	3	200	50	5			
ST QP12 D25 W25 L150 Z02	25	25	2	150	40	6			

## DEĞİŞKEN UCLU FREZELER

### End Mills with changeable insert

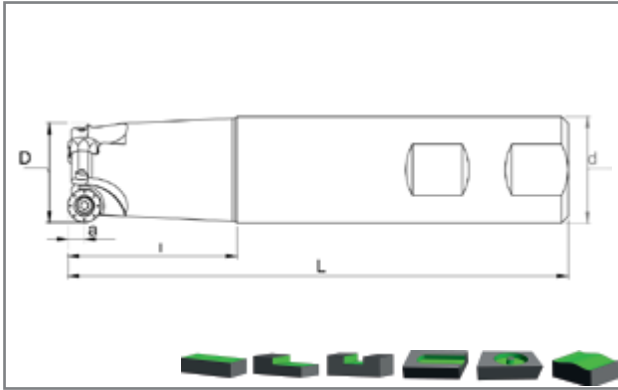

KOD CODE	ÖLÇÜLER DIMENSION (mm)						KESİCİ UÇ INSERT	YEDEK PARÇALAR SPARE PARTS	
	D	d	Z	L	l	a		Sıkma Vidası Clamp Screw	Anahtar Torx Key
<b>ST RPMT / RPGT 10T3 / 1204..</b>									
ST RPMT10 D25 W25 L150 Z02-H	25	25	2	150	40	5	RPMT / RPGT 10T3.. KYCR UCA UYGUNDUR FOR KYCR INSERT	SSV M3x8 9508	T08
ST RPMT10 D32 W32 L150 Z03-H	32	32	3	150	40	5			
ST RPMT10 D35 W32 L150 Z03-H	35	32	3	150	25	5			
ST RPMT12 D32 W32 L150 Z03-H	32	32	3	150	40	6	RPMT / RPGT 1204.. KYCR UCA UYGUNDUR FOR KYCR INSERT	SSV M4x10 9514	T15
ST RPMT12 D40 W32 L150 Z04-H	40	32	4	150	25	6			

KOD CODE	ÖLÇÜLER DIMENSION (mm)						KESİCİ UÇ INSERT	YEDEK PARÇALAR SPARE PARTS	
	D	d	Z	L	l	a		Sıkma Vidası Clamp Screw	Anahtar Torx Key
<b>ST RPMT 10T3 / 1204..</b>									
ST RP10T3 D20 W20 L150 Z02-H	20	20	2	150	40	5	RPMT 10T3.. MTSBSH UCA UYGUNDUR FOR MTSBSH INSERT	SSV M3.5x8 9510	T15
ST RP10T3 D25 W25 L150 Z02-H	25	25	2	150	40	5			
ST RP10T3 D32 W32 L150 Z03-H	32	32	3	150	40	5			
ST RP1204 D25 W25 L150 Z02-H	25	25	2	150	40	6	RPMT 1204.. MTSBSH UCA UYGUNDUR FOR MTSBSH INSERT	SSV M4x10 9514	T15

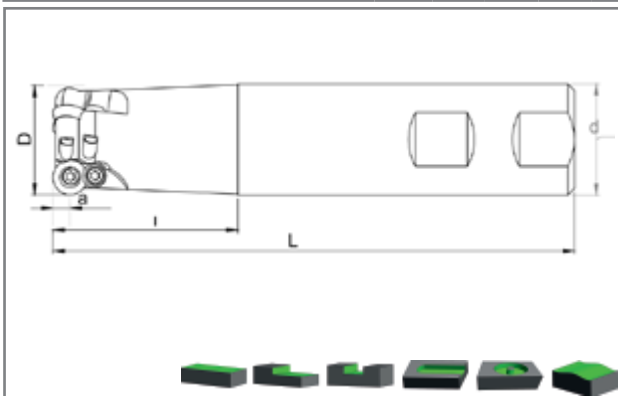





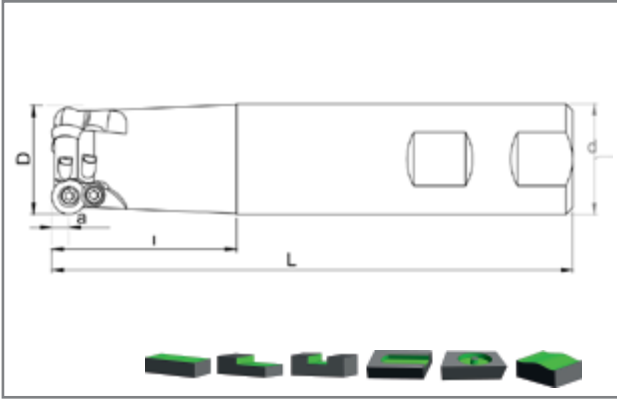

KOD CODE	ÖLÇÜLER DIMENSION (mm)						KESİCİ UÇ INSERT	YEDEK PARÇALAR SPARE PARTS			
	D	d	Z	L	l	a		Sıkma Vidası Clamp Screw		Sıkma Vidası Clamp Screw	Anahtar Torx Key
<b>ST RCKT 1204..</b>											
ST RC1204S D28 W25 L150 Z02-H	28	25	2	150	25	6	RCKT 1204.. SDVK UCA UYGUNDUR FOR SDVK INSERT	SSV M3.5x10 9511	RDTP 9124	SSV M3.5x11 9526	T15
ST RC1204S D32 W32 L150 Z03-H	32	32	3	150	40	6					
ST RC1204S D33 W32 L150 Z03	33	32	3	150	25	6					
ST RC1204S D35 W32 L150 Z03-H	35	32	3	150	25	6					

H-İÇTEN SU VERMELİ  
H-WITH COOLANT HOLE

## DEĞİŞKEN UCLU FREZELER

### End Mills with changeable insert



KOD CODE	ÖLÇÜLER DIMENSION (mm)						KESİCİ UÇ INSERT	YEDEK PARÇALAR SPARE PARTS			
	D	d	Z	L	l	a		Sıkma Vidası Clamp Screw	Baskı Parçası Wedge Clamp	Baskı Vidası Screw	Anahtar Torx Key
<b>ST RDMT</b> <b>0702 / 0803 / 1003 / 12T3..</b> <b>ISO</b>											
<b>ST RD07 D16 W16 L120 Z02</b>	16	16	2	150	30	3.5	<b>RDKW 0702..</b> <b>ZCC-CT</b> <b>UCA UYGUNDUR</b> <b>FOR ZCC-CT INSERT</b>	<b>SSV</b> <b>M2.5x6</b> <b>9505</b>	-	-	T08
<b>ST RD07 D20 W20 L120 Z02</b>	20	20	2	150	30	3.5					
<b>ST RD07 D25 W25 L120 Z03</b>	25	25	3	150	30	3.5					
<b>ST RD08 D16 W16 L120 Z02</b>	16	16	2	120	30	4	<b>RD.. 0803..</b> <b>ISO UCA</b> <b>UYGUNDUR</b> <b>FOR ISO INSERT</b>	<b>SSV</b> <b>M3x6</b> <b>9507</b>	-	-	T08
<b>ST RD08 D20 W20 L120 Z02</b>	20	20	2	120	30	4					
<b>ST RD08 D25 W25 L120 Z03</b>	25	25	3	120	30	4					
<b>ST RD08 D32 W32 L120 Z04</b>	32	32	4	120	30	4					
<b>ST RD08 D16 W16 L150 Z02</b>	16	16	2	150	40	4					
<b>ST RD08 D20 W20 L150 Z02</b>	20	20	2	150	40	4					
<b>ST RD08 D25 W25 L150 Z03</b>	25	25	3	150	40	4					
<b>ST RD08 D32 W32 L150 Z04</b>	32	32	4	150	40	4					
<b>ST RD08 D20 C20 L200 Z02</b>	20	20	2	200	50	4					
<b>ST RD08 D25 C25 L200 Z03</b>	25	25	3	200	50	4					
<b>ST RD08 D32 C32 L200 Z04</b>	32	32	4	200	50	4					
<b>ST RD10 D20 W20 L120 Z02</b>	20	20	2	120	30	5	<b>RD.. 1003..</b> <b>ISO UCA</b> <b>UYGUNDUR</b> <b>FOR ISO INSERT</b>	<b>SSV</b> <b>M3.5x10</b> <b>9511</b>	RDTP <b>9124</b>	<b>SSV</b> <b>M3.5x11</b> <b>9526</b>	T15
<b>ST RD10 D25 W25 L120 Z02</b>	25	25	2	120	30	5					
<b>ST RD10 D32 W25 L120 Z03</b>	32	25	3	120	25	5					
<b>ST RD10 D32 W32 L120 Z03</b>	32	32	3	120	30	5					
<b>ST RD10 D40 W32 L120 Z04</b>	40	32	4	120	25	5					
<b>ST RD10 D20 W20 L150 Z02</b>	20	20	2	150	40	5					
<b>ST RD10 D25 W25 L150 Z02</b>	25	25	2	150	40	5					
<b>ST RD10 D32 W32 L150 Z03</b>	32	32	3	150	40	5					
<b>ST RD10 D32 W25 L150 Z03</b>	32	25	3	150	25	5					
<b>ST RD10 D40 W32 L150 Z04</b>	40	32	4	150	25	5					
<b>ST RD10 D20 C20 L200 Z02</b>	20	20	2	200	50	5					
<b>ST RD10 D25 C25 L200 Z02</b>	25	25	2	200	50	5					
<b>ST RD10 D32 C32 L200 Z03</b>	32	32	3	200	50	5					
<b>ST RD10 D32 C25 L200 Z03</b>	32	25	3	200	25	5					
<b>ST RD10 D40 C32 L200 Z04</b>	40	32	4	200	25	5					
<b>ST RD12 D25 W25 L120 Z02</b>	25	25	2	120	30	6	<b>RD.. 12T3..</b> <b>ISO UCA</b> <b>UYGUNDUR</b> <b>FOR ISO INSERT</b>	<b>SSV</b> <b>M3.5x10</b> <b>9511</b>	RDTP <b>9124</b>	<b>SSV</b> <b>M3.5x11</b> <b>9526</b>	T15
<b>ST RD12 D32 W25 L120 Z03</b>	32	25	3	120	30	6					
<b>ST RD12 D40 W32 L120 Z04</b>	40	32	4	120	25	6					
<b>ST RD12 D25 W25 L150 Z02</b>	25	25	2	150	40	6					
<b>ST RD12 D32 W32 L150 Z03</b>	32	32	3	150	40	6					
<b>ST RD12 D32 W25 L150 Z03</b>	32	25	3	150	25	6					
<b>ST RD12 D40 W32 L150 Z04</b>	40	32	4	150	25	6					
<b>ST RD12 D25 C25 L200 Z02</b>	25	25	2	200	50	6					
<b>ST RD12 D32 C32 L200 Z03</b>	32	32	3	200	50	6					
<b>ST RD12 D32 C25 L200 Z03</b>	32	25	3	200	25	6					
<b>ST RD12 D40 C32 L200 Z04</b>	40	32	4	200	25	6					

## KÜRE UCLU FREZELER Ball Nose End Mills

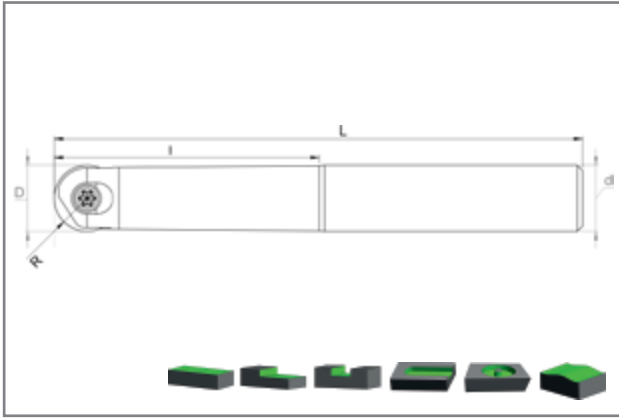

KOD CODE	ÖLÇÜLER DIMENSION (mm)					KESİCİ UÇ INSERT	YEDEK PARÇALAR SPARE PARTS	
	D	R	L	d	l		Sıkma Vidası Clamp Screw	Anahtar Allen Key
<b>SRT P32..</b>								
SRT P3208 D08 L110 d10	8	4	110	10	25	<b>P3208 WLTR UCA UYGUNDUR FOR WLTR INSERT</b>	TC170 3x7- <b>9801</b>	T08
<b>SRT P3210 D10 L130 d10</b>	<b>10</b>	<b>5</b>	<b>130</b>	<b>10</b>	<b>30</b>	<b>P3210 WLTR UCA UYGUNDUR FOR WLTR INSERT</b>	TC172 4x0.5x9- <b>9802</b>	T15
SRT P3210 D10 L130 d12	10	5	130	12	30	<b>P3212 WLTR UCA UYGUNDUR FOR WLTR INSERT</b>	TC174 5x0.5x9- <b>9803</b>	T20
SRT P3212 D12 L130 d12	12	6	130	12	32	<b>P3216 WLTR UCA UYGUNDUR FOR WLTR INSERT</b>	TC176 5x0.5x12- <b>9804</b>	T20
SRT P3216 D16 L175 d16	16	8	175	16	60	<b>P3220 WLTR UCA UYGUNDUR FOR WLTR INSERT</b>	TC178 5x0.5x12- <b>9805</b>	T20
SRT P3220 D20 L200 d20	20	10	200	20	100	<b>P3225 WLTR UCA UYGUNDUR FOR WLTR INSERT</b>	TC181 6x0.75x20- <b>9806</b>	AA3
SRT P3225 D25 L200 d25	25	12.5	200	25	100	<b>P3232 WLTR UCA UYGUNDUR FOR WLTR INSERT</b>	TC184 8x0.75x24- <b>9807</b>	AA4
SRT P3232 D32 L200 d32	32	16	200	32	100			

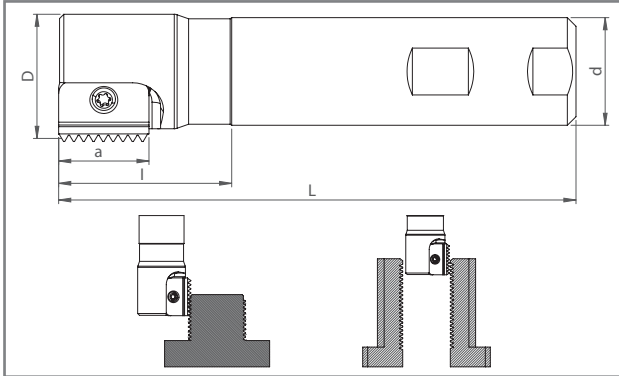



KOD CODE	ÖLÇÜLER DIMENSION (mm)						KESİCİ UÇ INSERT	YEDEK PARÇALAR SPARE PARTS	
	D	d	Z	L	l	a		Sıkma Vidası Clamp Screw	Anahtar Torx Key
<b>DİŞ AÇMA TAKIMLARI THREAD TOOLS</b>									
SDT C14 D12 W20 L100 Z01-H	12	20	1	100	30	14	<b>14 CPT UCA UYGUNDUR FOR CPT INSERT</b>	SSV M2.5x6 <b>9505</b>	T08
SDT C14 D14.5 W20 L100 Z01-H	14.5	20	1	100	30	14			
SDT C14 D17 W20 L100 Z01-H	17	20	1	100	30	14			
SDT C21 D18 W20 L100 Z01-H	18	20	1	100	40	21			
SDT C21 D21 W20 L120 Z01-H	21	20	1	120	40	21			
SDT C21 D25 W20 L120 Z01-H	25	20	1	120	-	21	<b>21 CPT UCA UYGUNDUR FOR CPT INSERT</b>	SSV M4x10- <b>9514</b>	T15
SDT C21 D29 W25 L120 Z01-H	29	25	1	120	-	21			
SDT C21 D38 W32 L120 Z02-H	38	32	2	120	-	21			

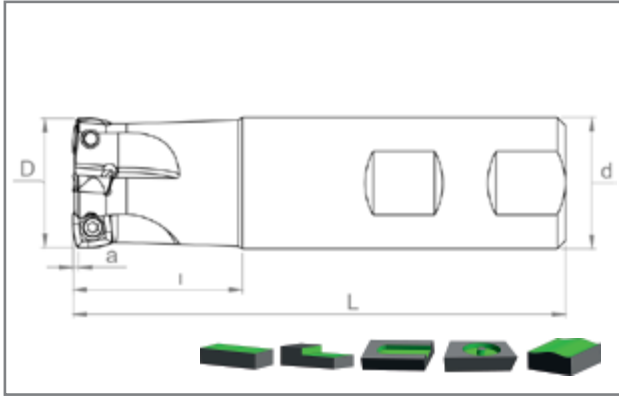

## HIZLI İLERLEMELİ SAPLI TARAMALAR

### High Feed End Mills

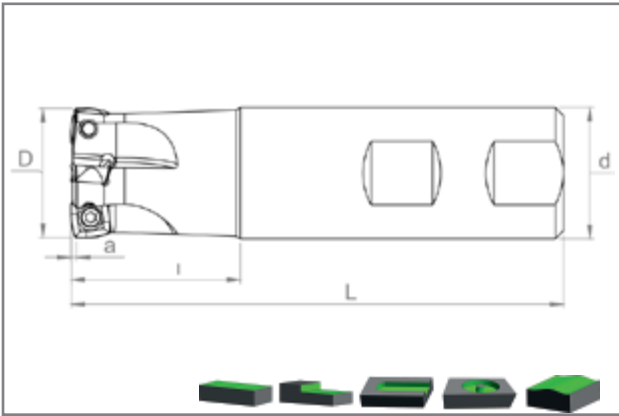

KOD CODE	ÖLÇÜLER DIMENSION (mm)						KESİCİ UÇ INSERT	YEDEK PARÇALAR SPARE PARTS	
	D	d	Z	L	I	a		Sıkma Vidası Clamp Screw	Anahtar Allen Key
<b>HST SDKX 0904..</b>									
HST SDKX09 D25 W25 L120 Z02-H	25	25	2	120	30	1.4	<b>SDKX 0904.. LAMINA UCA UYGUNDUR FOR LAMINA INSERT</b>	<b>SSV M3.5x8 SC 9513</b>	<b>T10</b>
HST SDKX09 D25 C25 L200 Z02	25	25	2	200	50	1.4			
HST SDKX09 D32 W32 L150 Z03-H	32	32	3	150	40	1.4			
HST SDKX09 D32 C32 L200 Z03	32	32	3	200	50	1.4			







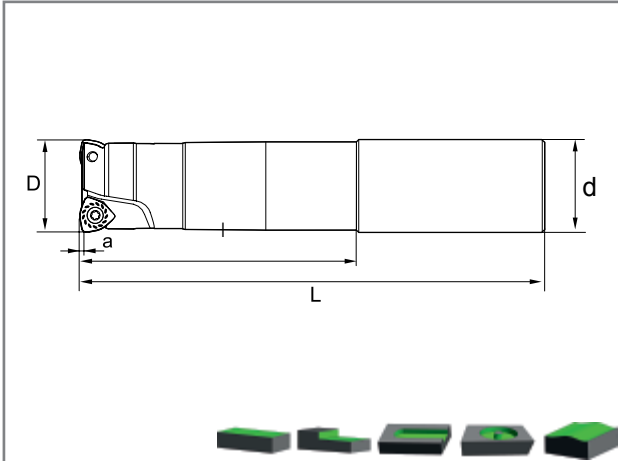

KOD CODE	ÖLÇÜLER DIMENSION (mm)						KESİCİ UÇ INSERT	YEDEK PARÇALAR SPARE PARTS	
	D	d	Z	L	I	a		Sıkma Vidası Clamp Screw	Anahtar Allen Key
<b>HST SDMT 09T3..</b>									
HST SDMT09 D25 W25 L150 Z02-H	25	25	2	150	40	1.4	<b>SDMT 09T3.. ZCC-CT UCA UYGUNDUR FOR ZCC-CT INSERT</b>	<b>SSV M3.5x8 SC 9513</b>	<b>T10</b>
HST SDMT09 D32 W25 L150 Z03-H	32	25	3	150	30	1.4			
HST SDMT09 D35 W32 L150 Z04-H	35	32	4	150	25	1.4			

## HIZLI İLERLEMELİ SAPLI TARAMALAR

### High Feed End Mills







KOD CODE	ÖLÇÜLER DIMENSION (mm)						KESİCİ UÇ INSERT	YEDEK PARÇALAR SPARE PARTS	
	D	d	Z	L	l	a		Sıkma Vidası Clamp Screw	Anahtar Allen Key
<b>HST WNMX 0603 / 09T3..</b>									
HST WN0603 D16 W16 L150 Z02-H	16	16	2	150	40	1	  <b>WNMX 0603.. KRLY UCA UYGUNDUR FOR KRLY INSERT</b> 	SSV M2.5x6 9505	T08
HST WN0603 D17 W16 L150 Z02-H	17	16	2	150	25	1			
HST WN0603 D20 W20 L150 Z02-H	20	20	2	150	40	1			
HST WN0603 D21 W20 L150 Z02-H	21	20	2	150	25	1			
HST WN0603 D25 W25 L150 Z03-H	25	25	3	150	40	1			
HST WN0603 D26 W25 L150 Z03-H	26	25	3	150	25	1			
HST WN0603 D32 W32 L150 Z04-H	32	32	4	150	40	1			
HST WN0603 D33 W32 L150 Z04-H	33	32	4	150	25	1	SSV M2.5x7 9506	T08	
HST WN09T3 D25 W25 L150 Z02-H	25	25	2	150	40	1.5			
HST WN09T3 D26 W25 L150 Z02-H	26	25	2	150	25	1.5	<b>WNMX 09T3.. KRLY UCA UYGUNDUR FOR KRLY INSERT</b>	SSV M3x8 9508	T08
HST WN09T3 D32 W25 L150 Z03-H	32	25	3	150	25	1.5			
HST WN09T3 D33 W32 L150 Z03-H	33	32	3	150	25	1.5			
HST WN09T3 D35 W32 L150 Z04-H	35	32	4	150	25	1.5			
HST WN09T3 D40 W32 L150 Z04-H	40	32	4	150	25	1.5			
HST WN09T3 D25 C25 L200 Z02	25	25	2	200	50	1.5			
HST WN09T3 D26 C25 L200 Z02	26	25	2	200	25	1.5			
HST WN09T3 D32 C25 L200 Z03	32	25	3	200	25	1.5			
HST WN09T3 D33 C32 L200 Z03	33	32	3	200	25	1.5			
HST WN09T3 D35 C32 L200 Z04	35	32	4	200	25	1.5			
HST WN09T3 D40 W32 L200 Z04-H	40	32	4	200	25	1.5			
HST WN09T3 D25 C25 L300 Z02	25	25	2	300	220	1.5			
HST WN09T3 D26 C25 L300 Z02	26	25	2	300	30	1.5			
HST WN09T3 D32 C32 L300 Z03	32	32	3	300	220	1.5			
HST WN09T3 D33 C32 L300 Z03	33	32	3	300	30	1.5			
HST WN09T3 D35 C32 L300 Z04	35	32	4	300	30	1.5			
HST WN09T3 D40 C32 L300 Z04	40	32	4	300	30	1.5			



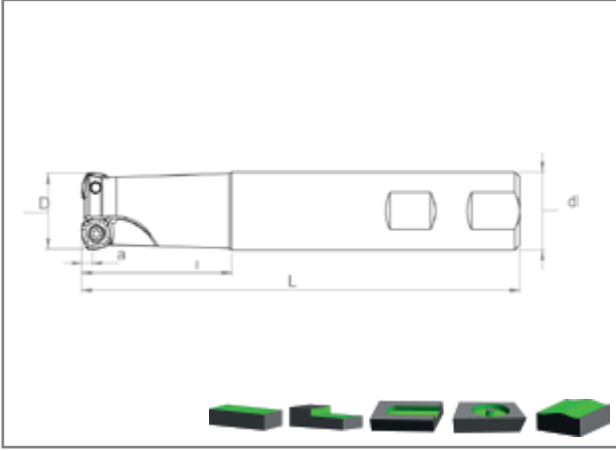



## HIZLI İLERLEMELİ SAPLI TARAMALAR

### High Feed End Mills

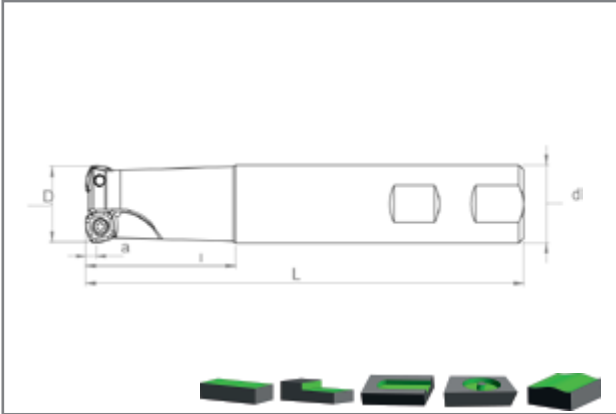

KOD CODE	ÖLÇÜLER DIMENSION (mm)						KESİCİ UÇ INSERT	YEDEK PARÇALAR SPARE PARTS	
	D	d	Z	L	l	a		Sıkma Vidası Clamp Screw	Anahtar Allen Key
<b>HST XPLX 0603..</b>									
HST XP06 D16 W16 L150 Z02-H	16	16	2	150	40	1	<b>XPLX 0603.. CRTZT UCA UYGUNDUR FOR CRTZT INSERT</b>	<b>SSV M2.5x6 9505</b>	<b>T08</b>
HST XP06 D17 W16 L150 Z02-H	17	16	2	150	25	1			
HST XP06 D20 W20 L150 Z03-H	20	20	3	150	40	1			
HST XP06 D21 W20 L150 Z03-H	21	20	3	150	25	1			
HST XP06 D16 W16 L200 Z02	16	16	2	200	40	1			
HST XP06 D17 W16 L200 Z02	17	16	2	200	25	1			







KOD CODE	ÖLÇÜLER DIMENSION (mm)						KESİCİ UÇ INSERT	YEDEK PARÇALAR SPARE PARTS	
	D	d	Z	L	l	a		Sıkma Vidası Clamp Screw	Anahtar Allen Key
<b>HST XDLX 09T3..</b>									
HST XD09 D25 W25 L150 Z02-H	25	25	2	150	40	1.2	<b>XDLX 09T3.. CRTZT UCA UYGUNDUR FOR CRTZT INSERT</b>	<b>SSV M3.5x8 9510</b>	<b>T15</b>
HST XD09 D26 W25 L150 Z02-H	26	25	2	150	25	1.2			
HST XD09 D25 W25 L200 Z02	25	25	2	200	50	1.2			
HST XD09 D26 W25 L200 Z02	26	25	2	200	25	1.2			

H-İÇTEN SU VERMELİ  
H-WITH COOLANT HOLE

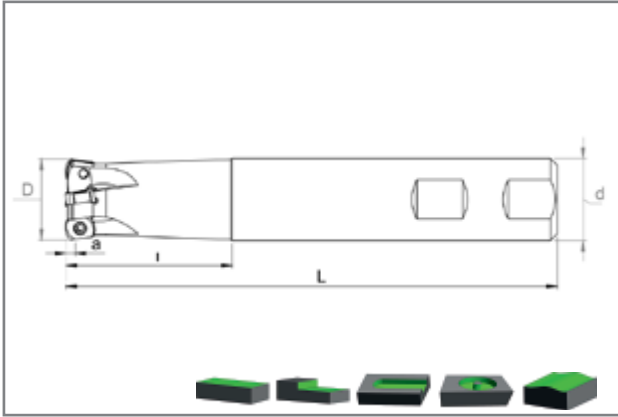

## HIZLI İLERLEMELİ SAPLI TARAMALAR

### High Feed End Mills

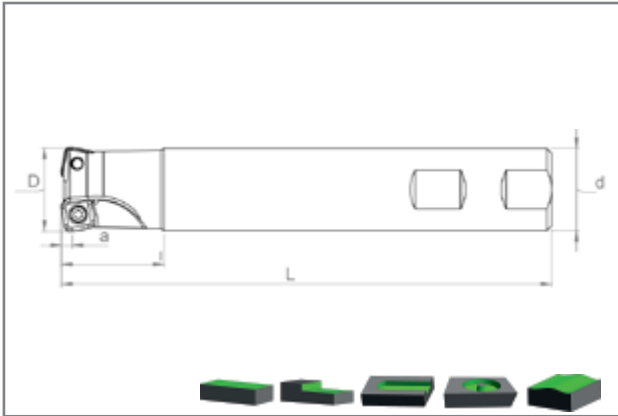

KOD CODE	ÖLÇÜLER DIMENSION (mm)						KESİCİ UÇ INSERT	YEDEK PARÇALAR SPARE PARTS	
	D	d	Z	L	l	a		Sıkma Vidası Clamp Screw	Anahtar Allen Key
<b>HST BLMP 0603..</b>									
HST BL06 D16 W16 L120 Z02-H	16	16	2	120	30	0.7	<b>BLMP 0603.. TGTC UCA UYGUNDUR FOR TGTC INSERT</b>	<b>SSV M2.5x6 9505</b>	<b>T08</b>
HST BL06 D20 W20 L150 Z03-H	20	20	3	150	40	1			
HST BL06 D25 W25 L150 Z04-H	25	25	4	150	40	1			
HST BL06 D32 W32 L150 Z05-H	32	32	5	150	40	1			
HST BL06 D20 C20 L200 Z03	20	20	3	200	50	1			
HST BL06 D25 C25 L200 Z04	25	25	4	200	50	1			
HST BL06 D32 C32 L200 Z05	32	32	5	200	50	1			







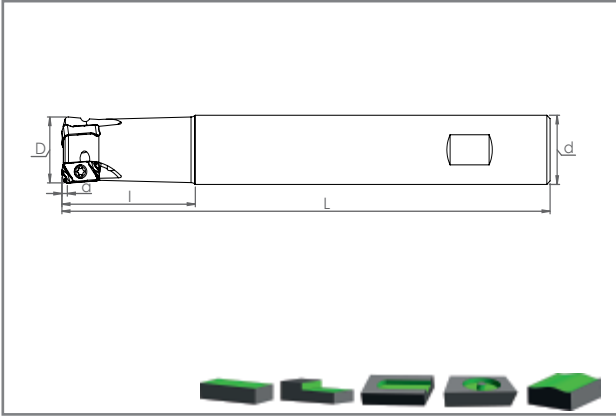

KOD CODE	ÖLÇÜLER DIMENSION (mm)						KESİCİ UÇ INSERT	YEDEK PARÇALAR SPARE PARTS	
	D	d	Z	L	l	a		Sıkma Vidası Clamp Screw	Anahtar Allen Key
<b>HST R210.09..</b>									
HST R210.09 D25 W25 L150 Z02-H	25	25	2	150	40	1.2	<b>R210-09.. SDVK UCA UYGUNDUR FOR SDVK INSERT</b>	<b>SSV M3.5x8 9510</b>	<b>T15</b>
HST R210.09 D26 W25 L150 Z02-H	26	25	2	150	25	1.2			
HST R210.09 D32 W32 L150 Z03-H	32	32	3	150	40	1.2			
HST R210.09 D33 W32 L150 Z03-H	33	32	3	150	25	1.2			

## HIZLI İLERLEMELİ SAPLI TARAMALAR

### High Feed End Mills



KOD CODE	ÖLÇÜLER DIMENSION (mm)						KESİCİ UÇ INSERT	YEDEK PARÇALAR SPARE PARTS	
	D	d	Z	L	l	a		Sıkma Vidası Clamp Screw	Anahtar Allen Key
<b>HST LNMU 0303..</b>									
HST LN03 D16 W16 L150 Z02-H	16	16	2	150	40	1	LNMU 0303.. TNGLY UCA UYGUNDUR FOR TNGLY INSERT	SSV M2.5x6-9505	T08
HST LN03 D18 W16 L150 Z02-H	18	16	2	150	25	1			
HST LN03 D20 W20 L150 Z03-H	20	20	3	150	40	1			
HST LN03 D22 W20 L150 Z03-H	22	20	3	150	25	1			
HST LN03 D25 W25 L150 Z04-H	25	25	4	150	40	1			

KOD CODE	ÖLÇÜLER DIMENSION (mm)						KESİCİ UÇ INSERT	YEDEK PARÇALAR SPARE PARTS	
	D	d	Z	L	l	a		Sıkma Vidası Clamp Screw	Anahtar Allen Key
<b>HST LNMU 06X5..</b> 									
HST LN06 D32 W32 L150 Z02-H	32	32	2	150	40	1.5	LNMU 06X5.. TNGLY UCA UYGUNDUR FOR TNGLY INSERT	SSV M5x13-9519	T20
HST LN06 D35 W32 L150 Z02-H	35	32	2	150	25	1.5			

## HIZLI İLERLEMELİ SAPLI TARAMALAR

### High Feed End Mills

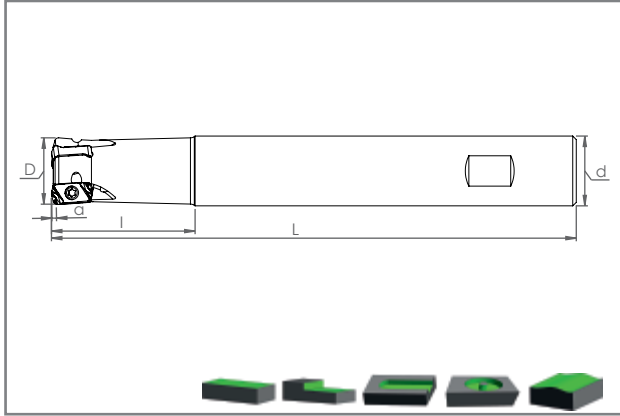

KOD CODE	ÖLÇÜLER DIMENSION (mm)						KESİCİ UÇ INSERT	YEDEK PARÇALAR SPARE PARTS	
	D	d	Z	L	l	a		Sıkma Vidası Clamp Screw	Anahtar Allen Key
<b>HST ENMU 1004..</b>									
HST EN10 D16 W16 L150 Z02-H	16	16	2	150	40	1.7	ENMU 1004.. DJT UCA UYGUNDUR FOR DJT INSERT	SSV M2.5x6-9505	T08
HST EN10 D20 W20 L150 Z03-H	20	20	3	150	40	1.7			
HST EN10 D25 W25 L150 Z04-H	25	25	4	150	40	1.7			
HST EN10 D32 W32 L150 Z05-H	32	32	5	150	40	1.7			

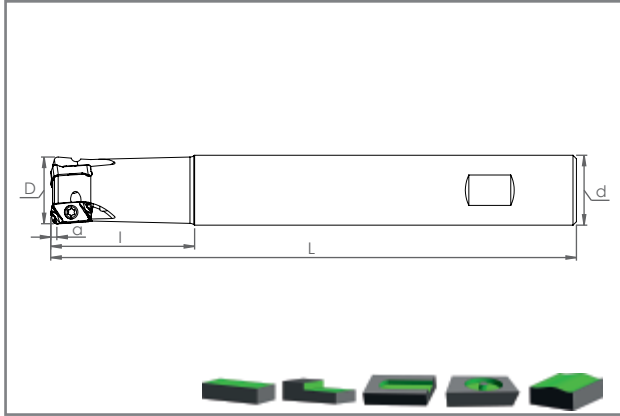



KOD CODE	ÖLÇÜLER DIMENSION (mm)							KESİCİ UÇ INSERT	YEDEK PARÇALAR SPARE PARTS	
	D	d	Z	L	l	a	a1 (90°)		Sıkma Vidası Clamp Screw	Anahtar Allen Key
<b>HST ZPMT / YPHW / EP.. 1003..</b>										
HST(90) ZP10 D16 W16 L150 Z02-H	16	16	2	150	40	1	9	ZPMT / YPHW / EP.. 1003.. DJT UCA UYGUNDUR FOR DJT INSERT	SSV M2.5x6-9505	T08
HST(90) ZP10 D20 W20 L150 Z03-H	20	20	3	150	40	1	9			
HST(90) ZP10 D25 W25 L150 Z04-H	25	25	4	150	40	1	9			
HST(90) ZP10 D32 W32 L150 Z05-H	32	32	5	150	40	1	9			

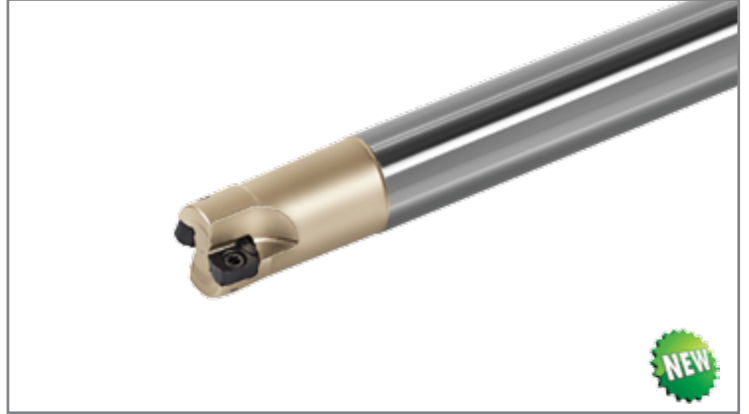
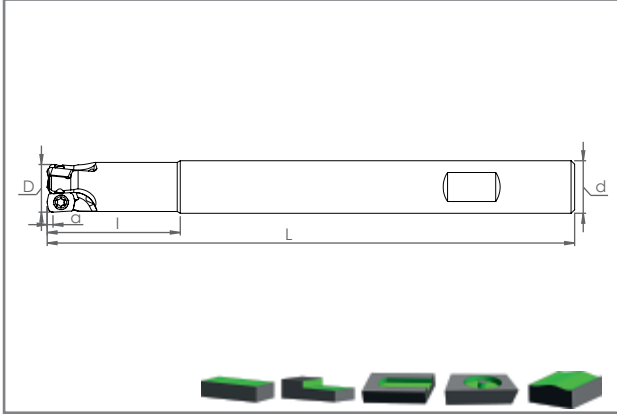

## HIZLI İLERLEMELİ SAPLI TARAMALAR

### High Feed End Mills

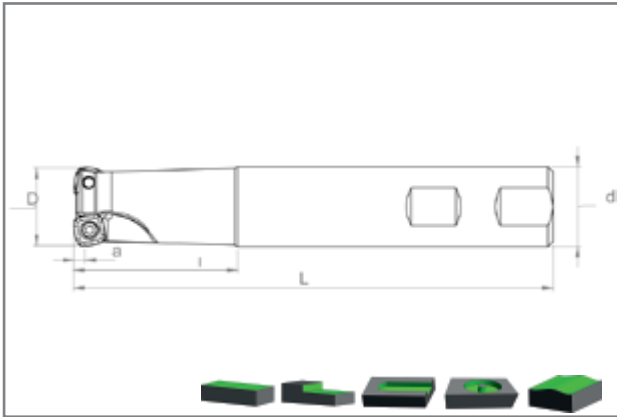

KOD CODE	ÖLÇÜLER DIMENSION (mm)						KESİCİ UÇ INSERT	YEDEK PARÇALAR SPARE PARTS	
	D	d	Z	L	I	a		Sıkma Vidası Clamp Screw	Anahtar Allen Key
<b>HST EOMT / ZOMT 0602..</b>									
HST EO06 D10 W10 L120 Z02-H	10	10	2	120	25	0.3	EOMT / ZOMT 0602.. DJT UCA UYGUNDUR FOR DJT INSERT	SSV M1.8x4 9501	T06
HST EO06 D12 W12 L120 Z02-H	12	12	2	120	25	0.3			



KOD CODE	ÖLÇÜLER DIMENSION (mm)						KESİCİ UÇ INSERT	YEDEK PARÇALAR SPARE PARTS	
	D	d	Z	L	I	a		Sıkma Vidası Clamp Screw	Anahtar Allen Key
<b>HST SPNW / SPET / SPMT 1004..</b>									
HST SP10 D25 W25 L150 Z02-H	25	25	2	150	40	1.6	SPNW / SPET / SPMT 1004.. DJT UCA UYGUNDUR FOR DJT INSERT	SSV M3.5x8-9510	T15
HST SP10 D32 W32 L150 Z03-H	32	32	3	150	40	1.6			

H-İÇTEN SU VERMELİ  
H-WITH COOLANT HOLE

## HIZLI İLERLEMELİ SAPLI TARAMALAR

### High Feed End Mills

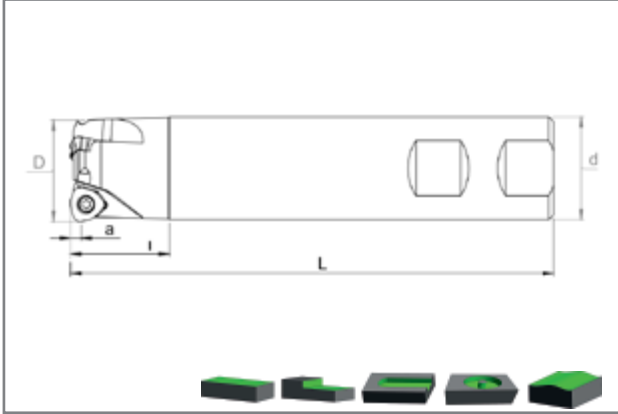

KOD CODE	ÖLÇÜLER DIMENSION (mm)						KESİCİ UÇ INSERT	YEDEK PARÇALAR SPARE PARTS	
	D	d	Z	L	l	a		Sıkma Vidası Clamp Screw	Anahtar Allen Key
<b>HST WDMW 06T3..</b>									
HST WDMW06 D25 W25 L150 Z02-H	25	25	2	150	40	1.5	WDMW 06T3.. DJT UCA UYGUNDUR FOR DJT INSERT	SSV M3.5x8 SC-9513	T10
HST WDMW06 D32 W32 L150 Z03-H	32	32	3	150	40	1.5			

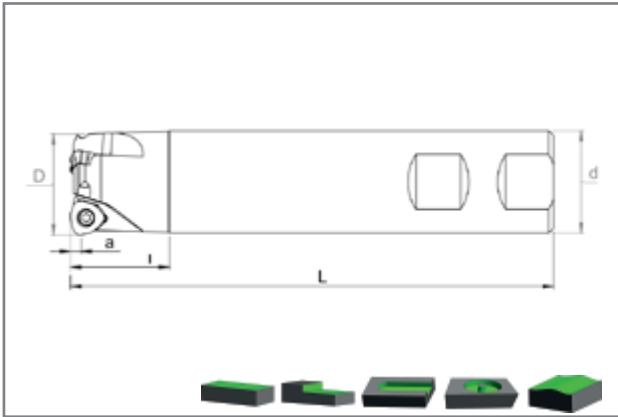



KOD CODE	ÖLÇÜLER DIMENSION (mm)						KESİCİ UÇ INSERT	YEDEK PARÇALAR SPARE PARTS	
	D	d	Z	L	l	a		Sıkma Vidası Clamp Screw	Anahtar Allen Key
<b>HST WOM. 04T2..</b>									
HST WO04 D16 W16 L150 Z02-H	16	16	2	150	40	1.2	WOM. 04T2.. DJT UCA UYGUNDUR FOR DJT INSERT	SSV M2.5x6-9505	T08
HST WO04 D20 W20 L150 Z03-H	20	20	3	150	40	1.2			

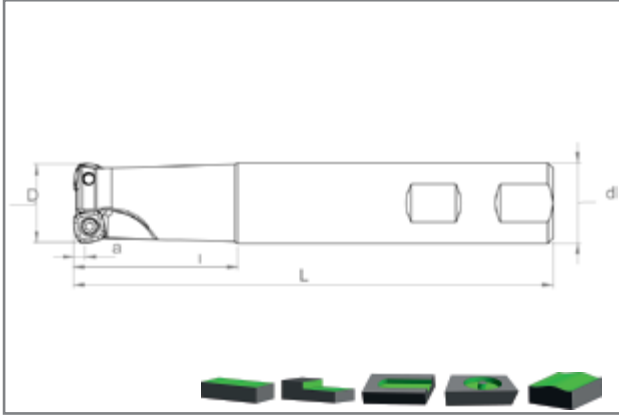

## HIZLI İLERLEMELİ SAPLI TARAMALAR

### High Feed End Mills

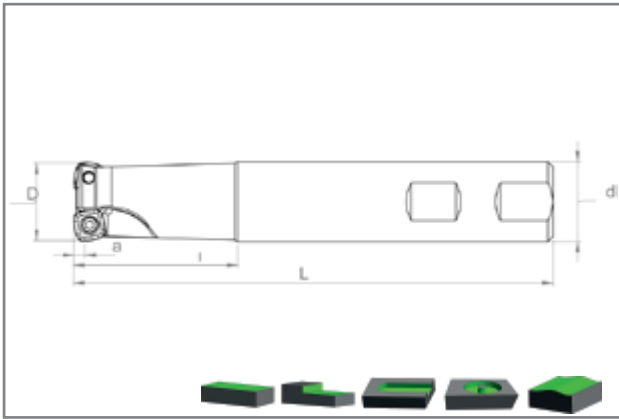

KOD CODE	ÖLÇÜLER DIMENSION (mm)						KESİCİ UÇ INSERT	YEDEK PARÇALAR SPARE PARTS	
	D	d	Z	L	I	a		Sıkma Vidası Clamp Screw	Anahtar Allen Key
<b>HST ZDCW 09T3..</b>									
HST ZD09 D25 W25 L150 Z02-H	25	25	2	150	40	1.3	<b>ZDCW 09T3.. PRMT UCA UYGUNDUR FOR PRMT INSERT</b>	<b>SSV M3x8 9508</b>	<b>T08</b>
HST ZD09 D32 W32 L150 Z03-H	32	32	3	150	40	1.3			







KOD CODE	ÖLÇÜLER DIMENSION (mm)						KESİCİ UÇ INSERT	YEDEK PARÇALAR SPARE PARTS	
	D	d	Z	L	I	a		Sıkma Vidası Clamp Screw	Anahtar Allen Key
<b>HST BNGX 10T3..</b>									
HST BN10 D16 W16 L150 Z02-H	16	16	2	150	40	1	<b>BNGX 10T3.. PRMT UCA UYGUNDUR FOR PRMT INSERT</b>	<b>SSV M2.5x6 9505</b>	<b>T08</b>
HST BN10 D20 W20 L150 Z03-H	20	20	3	150	40	1			
HST BN10 D25 W25 L150 Z04-H	25	25	4	150	40	1			
HST BN10 D32 W32 L150 Z05-H	32	32	5	150	40	1			

H-İÇTEN SU VERMELİ  
H-WITH COOLANT HOLE

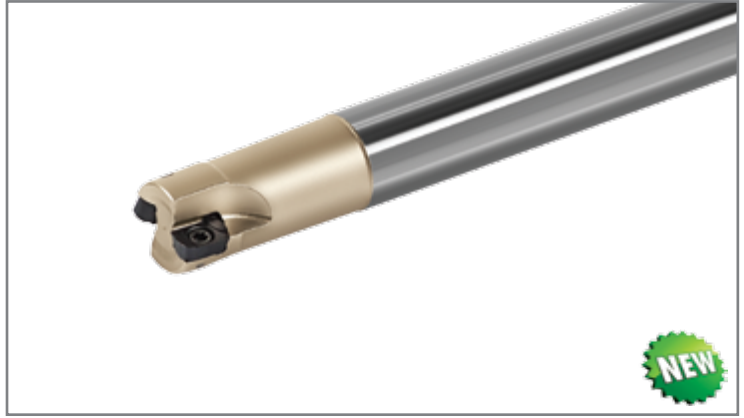
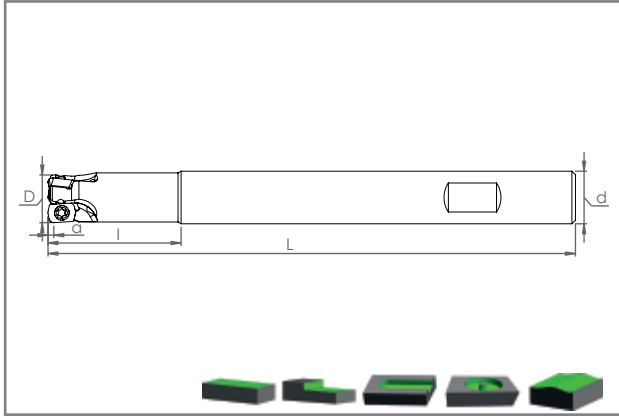

## HIZLI İLERLEMELİ SAPLI TARAMALAR

### High Feed End Mills

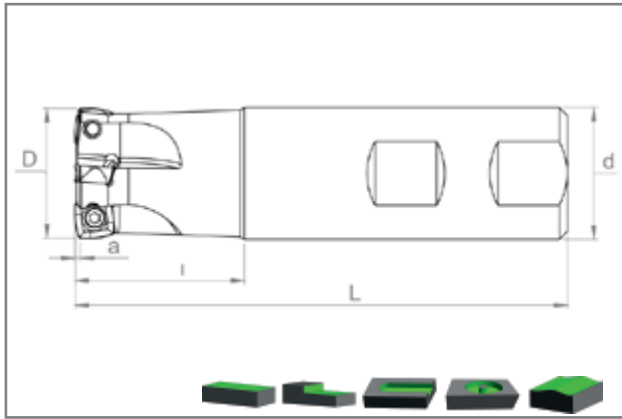

KOD CODE	ÖLÇÜLER DIMENSION (mm)						KESİCİ UÇ INSERT	YEDEK PARÇALAR SPARE PARTS	
	D	d	Z	L	I	a		Sıkma Vidası Clamp Screw	Anahtar Allen Key
<b>HST LPMT / LPMW / LPEW 0402..</b>									
HST LP04 D10 C10 L120 Z02-H	10	10	2	120	30	0.4	LPMT / LPMW / LPEW 0402.. KRLY UCA UYGUNDUR FOR KRLY INSERT	SSV M1.8x4 9501	T06
HST LP04 D12 C12 L120 Z02-H	12	12	2	120	30	0.4			
HST LP04 D14 C12 L120 Z03-H	14	12	3	120	25	0.4			







KOD CODE	ÖLÇÜLER DIMENSION (mm)						KESİCİ UÇ INSERT	YEDEK PARÇALAR SPARE PARTS	
	D	d	Z	L	I	a		Sıkma Vidası Clamp Screw	Anahtar Allen Key
<b>HST SPKT 08T3..</b>									
HST SPKT08 D20 W20 L150 Z02-H	20	20	2	150	40	1.5	SPKT 08T3.. PALBIT UCA UYGUNDUR FOR PALBIT INSERT	SSV M3x6-9507	T08
HST SPKT08 D25 W25 L150 Z03-H	25	25	3	150	40	1.5			
HST SPKT08 D32 W32 L150 Z04-H	32	32	4	150	40	1.5			



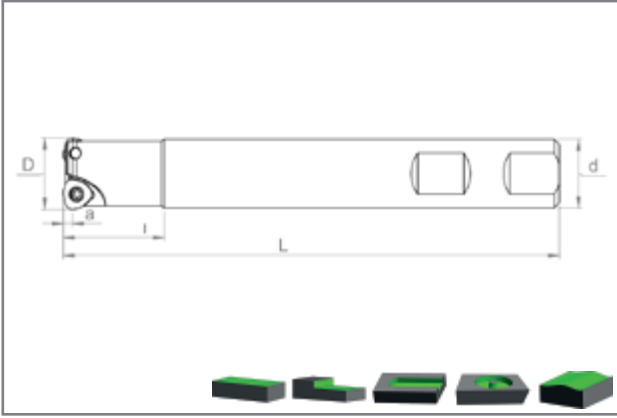



## HIZLI İLERLEMELİ SAPLI TARAMALAR

### High Feed End Mills

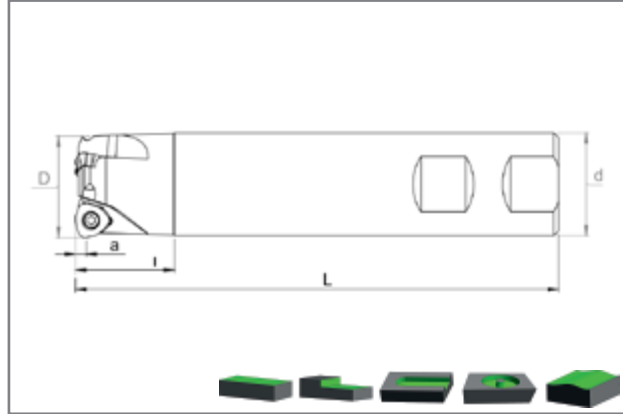

KOD CODE	ÖLÇÜLER DIMENSION (mm)						KESİCİ UÇ INSERT	YEDEK PARÇALAR SPARE PARTS	
	D	d	Z	L	l	a		Sıkma Vidası Clamp Screw	Anahtar Allen Key
<b>HST JOMT 06T2 / 0803..</b>									
HST JO06 D16 W16 L120 Z02-H	16	16	2	120	30	1	<b>JOMT 06T2.. MTSBSH UCA UYGUNDUR FOR MTSBSH INSERT</b>	<b>SSV M2.5x5-9504</b>	<b>T08</b>
HST JO06 D17 W16 L120 Z02-H	17	16	2	120	25	1			
HST JO06 D20 W20 L120 Z03-H	20	20	3	120	30	1			
HST JO06 D22 W20 L120 Z03-H	22	20	3	120	25	1			
HST JO08 D17 W16 L150 Z01-H	17	16	1	150	25	1.5	<b>JOMT 0803.. MTSBSH UCA UYGUNDUR FOR MTSBSH INSERT</b>	<b>SSV M3x6-9507</b>	<b>SSV M3x8-9508</b>
HST JO08 D21 W20 L150 Z02-H	21	20	2	150	25	1.5			
HST JO08 D26 W25 L150 Z03-H	26	25	3	150	25	1.5			



KOD CODE	ÖLÇÜLER DIMENSION (mm)						KESİCİ UÇ INSERT	YEDEK PARÇALAR SPARE PARTS	
	D	d	Z	L	l	a		Sıkma Vidası Clamp Screw	Anahtar Allen Key
<b>HST JDM. 09T3..</b>									
HST JD09 D25 W25 L150 Z02-H	25	25	2	150	40	2	<b>JDM 09T3.. MTSBSH UCA UYGUNDUR FOR MTSBSH INSERT</b>	<b>SSV M3.5x8-9510</b>	<b>T15</b>
HST JD09 D26 W25 L150 Z02-H	26	25	2	150	25	2			
HST JD09 D32 W32 L150 Z03-H	32	32	3	150	40	2			
HST JD09 D33 W32 L150 Z03-H	33	32	3	150	25	2			

## HIZLI İLERLEMELİ SAPLI TARAMALAR

### High Feed End Mills

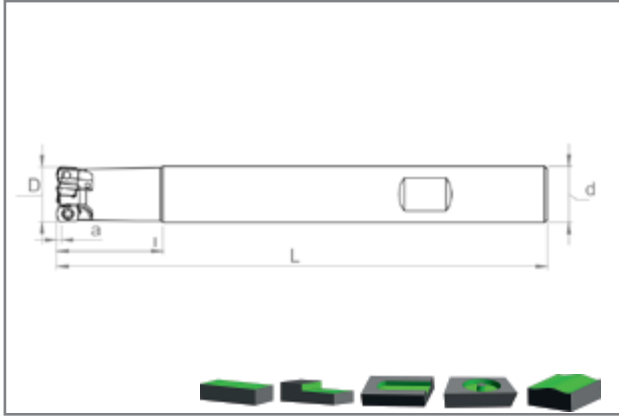

KOD CODE	ÖLÇÜLER DIMENSION (mm)						KESİCİ UÇ INSERT	YEDEK PARÇALAR SPARE PARTS	
	D	d	Z	L	l	a		Sıkma Vidası Clamp Screw	Anahtar Allen Key
<b>HST LPGT 0102..</b>									
HST LP01 D10 C10 L100 Z02-H	10	10	2	100	30	0.5	LPGT 0102.. KYCR UCA UYGUNDUR FOR KYCR INSERT	SSV M2x4 9521	T06
HST LP01 D12 C12 L120 Z03-H	12	12	3	120	30	0.5			
<b>HST LP01 D14 C12 L120 Z03-H</b>	14	12	3	120	25	0.5			
HST LP01 D16 C16 L120 Z04-H	16	16	4	120	30	0.5			

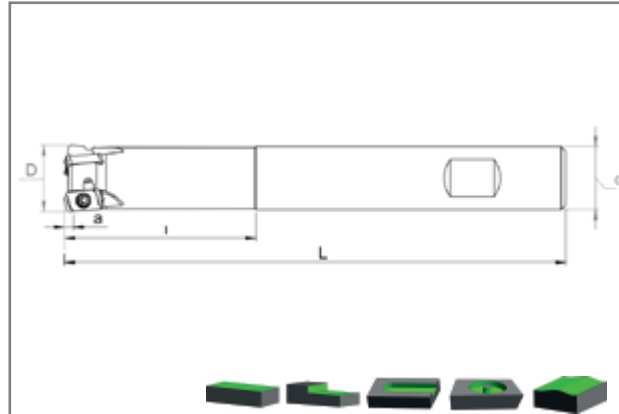



KOD CODE	ÖLÇÜLER DIMENSION (mm)						KESİCİ UÇ INSERT	YEDEK PARÇALAR SPARE PARTS	
	D	d	Z	L	l	a		Sıkma Vidası Clamp Screw	Anahtar Allen Key
<b>HST LOGU 0303..</b>									
HST LG03 D16 W16 L150 Z02-H	16	16	2	150	40	1	LOGU 0303.. KYCR UCA UYGUNDUR FOR KYCR INSERT	SSV M3x6 LG 9509	T08
HST LG03 D20 W20 L150 Z03-H	20	20	3	150	40	1			
HST LG03 D21 W20 L150 Z03-H	21	20	3	150	25	1			
HST LG03 D22 W20 L150 Z03-H	22	20	3	150	25	1			
HST LG03 D25 W25 L150 Z04-H	25	25	4	150	40	1			
HST LG03 D32 W32 L150 Z05-H	32	32	5	150	40	1			

H-İÇTEN SU VERMELİ  
H-WITH COOLANT HOLE

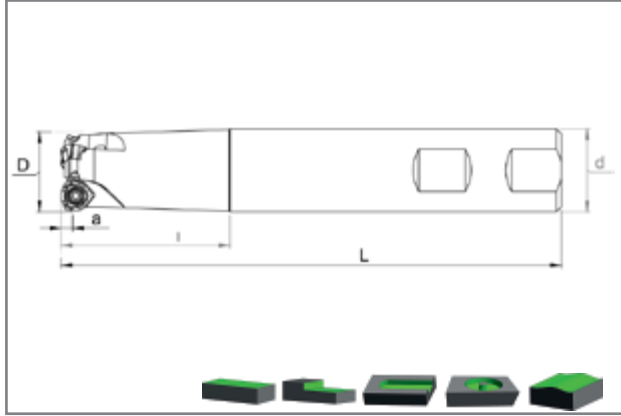

## HIZLI İLERLEMELİ SAPLI TARAMALAR

### High Feed End Mills

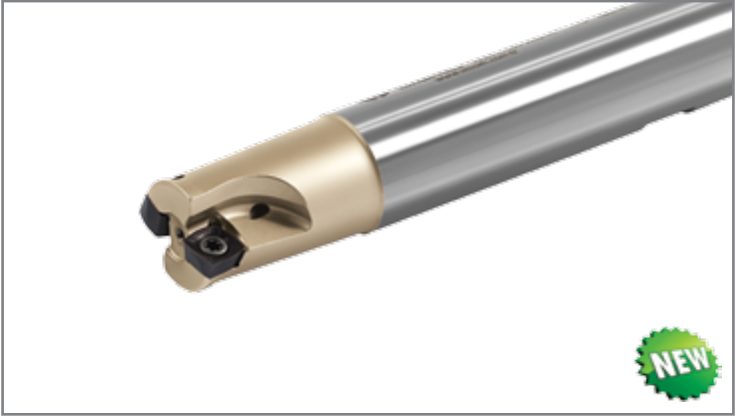
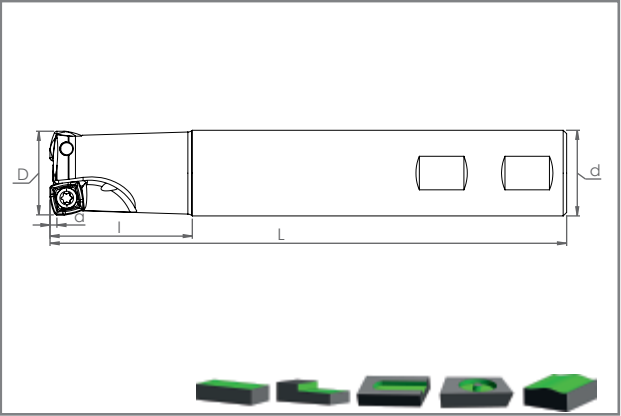

KOD CODE	ÖLÇÜLER DIMENSION (mm)						KESİCİ UÇ INSERT	YEDEK PARÇALAR SPARE PARTS	
	D	d	Z	L	l	a		Sıkma Vidası Clamp Screw	Anahtar Allen Key
<b>HST WDMT 0603 / 0804..</b>									
HST WD06 D16 W16 L120 Z02-H	16	16	2	120	30	1	<b>WDMT 0603.. SMTM UCA UYGUNDUR FOR SMTM INSERT</b>	<b>SSV M2.5x5-9505</b>	<b>T08</b>
HST WD06 D18 W16 L120 Z02-H	18	16	2	120	25	1			
HST WD06 D20 W20 L120 Z03-H	20	20	3	120	30	1			
HST WD06 D22 W20 L120 Z03-H	22	20	3	120	25	1			
HST WD08 D20 W20 L150 Z02-H	20	20	2	150	40	1.5	<b>WDMT 0804.. SMTM UCA UYGUNDUR FOR SMTM INSERT</b>	<b>SSV M3x6-9507</b>	
HST WD08 D22 W20 L150 Z02-H	22	20	2	150	25	1.5			
HST WD08 D25 W25 L150 Z03-H	25	25	3	150	40	1.5			
HST WD08 D26 W25 L150 Z03-H	26	25	3	150	25	1.5			
HST WD08 D32 W32 L150 Z04-H	32	32	4	150	40	1.5			
HST WD08 D33 W32 L150 Z04-H	33	32	4	150	25	1.5			



KOD CODE	ÖLÇÜLER DIMENSION (mm)						KESİCİ UÇ INSERT	YEDEK PARÇALAR SPARE PARTS	
	D	d	Z	L	l	a		Sıkma Vidası Clamp Screw	Anahtar Allen Key
<b>HST XPLT 0603.. XDLT 0904..</b>									
HST XPLT06 D16 W16 L150 Z02-H	16	16	2	150	40	0.9	<b>XPLT 0603.. KNMTL UCA UYGUNDUR FOR KNMTL INSERT</b>	<b>SSV M2.5x6-9505</b>	<b>T08</b>
HST XPLT06 D20 W20 L150 Z03-H	20	20	3	150	40	0.9			
HST XPLT06 D25 W25 L150 Z04-H	25	25	4	150	40	0.9			
HST XPLT06 D32 W32 L150 Z05-H	32	32	5	150	40	0.9			
HST XDLT09 D25 W25 L150 Z02-H	25	25	2	150	40	1.45	<b>XDLT 0904.. KNMTL UCA UYGUNDUR FOR KNMTL INSERT</b>	<b>SSV M3.5x8-9510</b>	
HST XDLT09 D32 W32 L150 Z03-H	32	32	3	150	40	1.45			
HST XDLT09 D40 W32 L150 Z04-H	40	32	4	150	25	1.45			

H-İÇTEN SU VERMELİ  
H-WITH COOLANT HOLE

**Teknoloji profesyonellikle birleŖti**  
Technology combined with professionalism

[www.smoxh.com.tr](http://www.smoxh.com.tr)

## **DEĐIŐTİRİLEBİLİR UCLU MODÜLER FREZELER**

Modular End Mills with changeable insert



## DEĞİŞTİRİLEBİLİR UCLU MODÜLER FREZELER

Modular End Mills with changeable insert

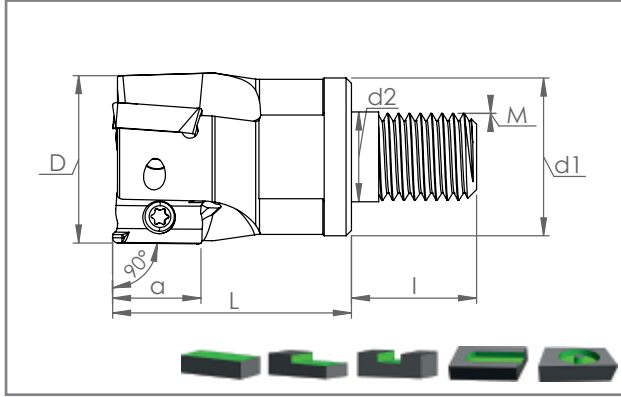

KOD CODE	ÖLÇÜLER DIMENSION (mm)								KESİCİ UÇ INSERT	YEDEK PARÇALAR SPARE PARTS	
	D	Z	d1	d2	L	I	M	a		Sıkma Vidası Clamp Screw	Anahtar Torx Key
<b>MT90 APKT 1003.. ISO</b>											
MT90 AP10 D16 M08 L25 Z02-H	16	2	15	8.5	25	17	8	10	AP. 1003.. ISO UCA UYGUNDUR FOR ISO INSERT	SSV M2.5x5 9504	T08
MT90 AP10 D20 M10 L30 Z03-H	20	3	18	10.5	30	19	10	10			
MT90 AP10 D25 M12 L35 Z03-H	25	3	21	12.5	35	23	12	10			
MT90 AP10 D32 M16 L43 Z04-H	32	4	29	17	43	23	16	10			
MT90 AP10 D40 M16 L43 Z05-H	40	5	29	17	43	23	16	10			
MT90 AP10 D42 M16 L43 Z05-H	42	5	29	17	43	23	16	10			

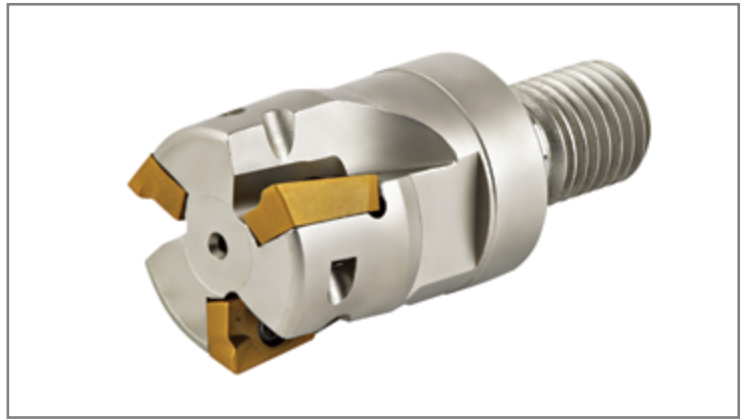
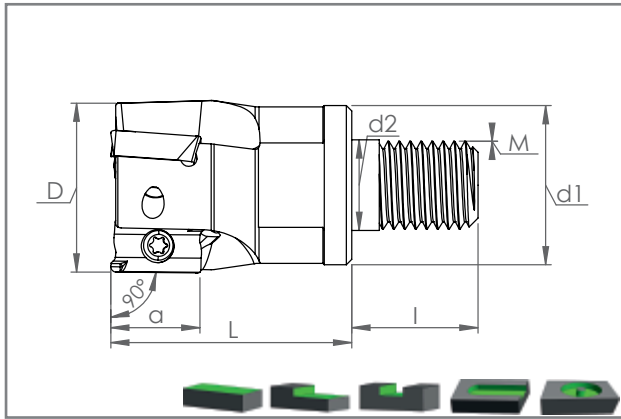

KOD CODE	ÖLÇÜLER DIMENSION (mm)								KESİCİ UÇ INSERT	YEDEK PARÇALAR SPARE PARTS	
	D	Z	d1	d2	L	I	M	a		Sıkma Vidası Clamp Screw	Anahtar Torx Key
<b>MT90 APKT 1604.. ISO</b>											
MT90 AP16 D25 M12 L35 Z02-H	25	2	21	12.5	35	23	12	16	AP. 1604.. ISO UCA UYGUNDUR FOR ISO INSERT	SSV M3.5x8 9510	T15
MT90 AP16 D32 M16 L43 Z03-H	32	3	29	17	43	23	16	16			
MT90 AP16 D40 M16 L43 Z04-H	40	4	29	17	43	23	16	16			
MT90 AP16 D42 M16 L43 Z04-H	42	4	29	17	43	23	16	16			

H-İÇTEN SU VERMELİ  
H-WITH COOLANT HOLE

## DEĞİŞTİRİLEBİLİR UCLU MODÜLER FREZELER

Modular End Mills with changeable insert

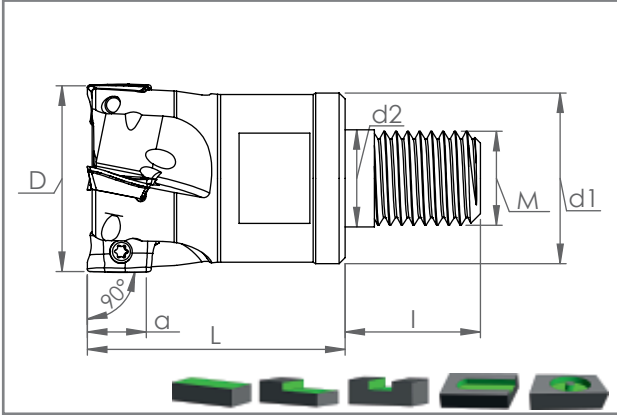

KOD CODE	ÖLÇÜLER DIMENSION (mm)								KESİCİ UÇ INSERT	YEDEK PARÇALAR SPARE PARTS	
	D	Z	d1	d2	L	I	M	a		Sıkma Vidası Clamp Screw	Anahtar Torx Key
<b>MT90 AX.T 1235..</b>											
MT90 AX12 D16 M08 L25 Z02-H	16	2	15	8.5	25	17	8	11	AX.T 1235.. SMTM UCA UYGUNDUR FOR SMTM INSERT	SSV M3x5 LG-9525	T08
MT90 AX12 D20 M10 L30 Z03-H	20	3	18	10.5	30	19	10	11		SSV M3x6 LG-9509	
MT90 AX12 D25 M12 L35 Z04-H	25	4	21	12.5	35	23	12	11			

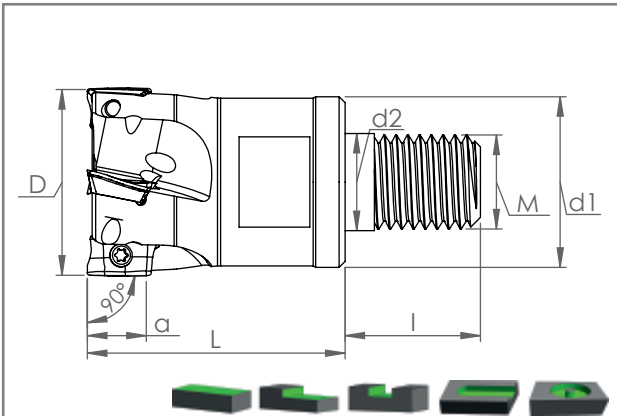



KOD CODE	ÖLÇÜLER DIMENSION (mm)								KESİCİ UÇ INSERT	YEDEK PARÇALAR SPARE PARTS	
	D	Z	d1	d2	L	I	M	a		Sıkma Vidası Clamp Screw	Anahtar Torx Key
<b>MT90 R390.11</b>											
MT90 R390.11 D16 M08 L25 Z02-H	16	2	15	8.5	25	17	8	10	SDVK R390.11 SDVK UCA UYGUNDUR FOR SDVK INSERT	SSV M2.5x5-9504	T08
MT90 R390.11 D20 M10 L30 Z03-H	20	3	18	10.5	30	19	10	10		SSV M2.5x6-9505	
MT90 R390.11 D25 M12 L35 Z03-H	25	3	21	12.5	35	23	12	10			
MT90 R390.11 D32 M16 L43 Z04-H	32	4	29	17	43	23	16	10			

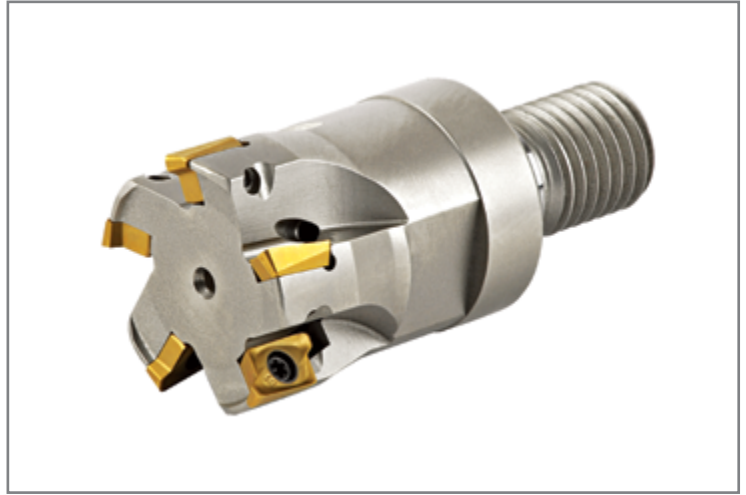
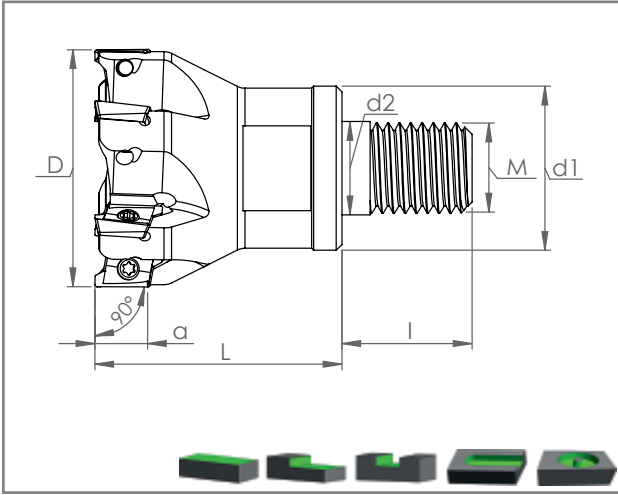

## DEĞİŞTİRİLEBİLİR UCLU MODÜLER FREZELER

Modular End Mills with changeable insert

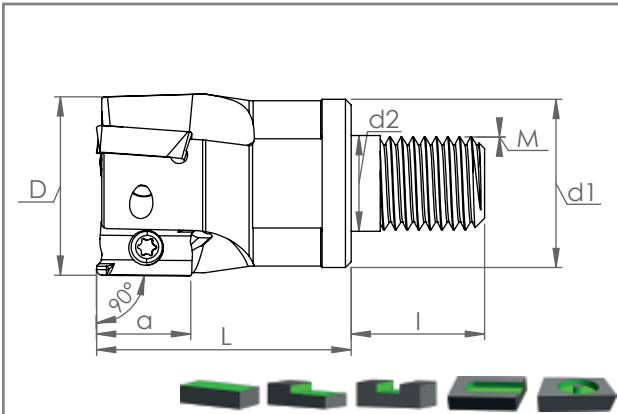

KOD CODE	ÖLÇÜLER DIMENSION (mm)								KESİCİ UÇ INSERT	YEDEK PARÇALAR SPARE PARTS	
	D	Z	d1	d2	L	I	M	a		Sıkma Vidası Clamp Screw	Anahtar Torx Key
<b>MT90 RT 1003</b>											
MT90 RT10 D25 M12 L35 Z04-H	25	4	21	12.5	35	23	12	10	<b>RT 1003.. SAFETY UCA UYGUNDUR FOR SAFETY INSERT</b>	SSV M2.5x6 <b>9505</b>	T08
MT90 RT10 D32 M16 L43 Z05-H	32	5	29	17	43	23	16	10			
MT90 RT10 D42 M16 L43 Z06-H	42	6	29	17	43	23	16	10			



KOD CODE	ÖLÇÜLER DIMENSION (mm)								KESİCİ UÇ INSERT	YEDEK PARÇALAR SPARE PARTS	
	D	Z	d1	d2	L	I	M	a		Sıkma Vidası Clamp Screw	Anahtar Torx Key
<b>MT90 BDMT 1103..</b>											
MT90 BD11 D16 M08 L25 Z02-H	16	2	15	8.5	25	17	8	10	<b>BDMT 1103.. KYCR UCA UYGUNDUR FOR KYCR INSERT</b>	SSV M2.5x5- <b>9504</b>	T08
MT90 BD11 D20 M10 L30 Z03-H	20	3	18	10.5	30	19	10	10			
MT90 BD11 D25 M12 L35 Z04-H	25	4	21	12.5	35	23	12	10			
MT90 BD11 D32 M16 L43 Z05-H	32	5	29	17	43	23	16	10		SSV M2.5x6 <b>9505</b>	

H-İÇTEN SU VERMELİ  
H-WITH COOLANT HOLE

## DEĞİŞTİRİLEBİLİR UCLU MODÜLER FREZELER

### Modular End Mills with changeable insert

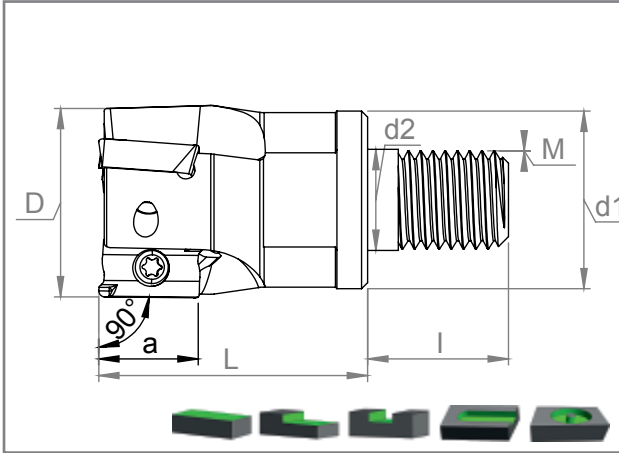

KOD CODE	ÖLÇÜLER DIMENSION (mm)								KESİCİ UÇ INSERT	YEDEK PARÇALAR SPARE PARTS	
	D	Z	d1	d2	L	l	M	a		Sıkma Vidası Clamp Screw	Anahtar Torx Key
<b>MT90 XOMX 10T3 / 1204..</b>											
MT90 XO10 D16 M08 L25 Z02-H	16	2	15	8.5	25	17	8	9	XOMX 10T3.. SECO UCA UYGUNDUR FOR SECO INSERT	SSV M2.5x6-9505	T08
MT90 XO10 D20 M10 L30 Z03-H	20	3	18	10.5	30	19	10	9		SSV M3.5x8 SC 9513	T10
MT90 XO12 D20 M10 L30 Z02-H	20	2	18	10.5	30	19	10	11	XOMX 1204.. SECO UCA UYGUNDUR FOR SECO INSERT	SSV M3.5x8 SC 9513	T10
MT90 XO12 D25 M12 L35 Z03-H	25	3	21	12.5	35	23	12	11			
MT90 XO12 D32 M16 L43 Z04-H	32	4	29	17	43	23	16	11			

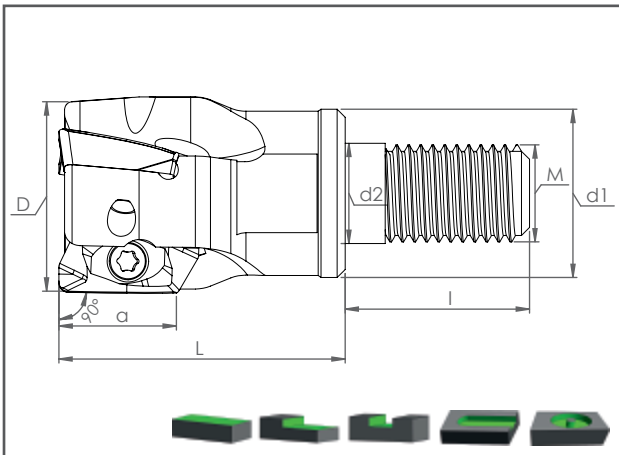

KOD CODE	ÖLÇÜLER DIMENSION (mm)								KESİCİ UÇ INSERT	YEDEK PARÇALAR SPARE PARTS	
	D	Z	d1	d2	L	l	M	a		Sıkma Vidası Clamp Screw	Anahtar Torx Key
<b>MT90 EDPT 10T3 / 1404..</b>											
MT90 ED10 D16 M08 L25 Z02-H	16	2	15	8.5	25	17	8	10	EDPT 10T3.. KNMTL UCA UYGUNDUR FOR KNMTL INSERT	SSV M2.5x5 9504	T08
MT90 ED10 D20 M10 L30 Z03-H	20	3	18	10.5	30	19	10	10		SSV M2.5x6-9505	
MT90 ED10 D25 M12 L35 Z04-H	25	4	21	12.5	35	23	12	10	SSV M3x6-9507		
MT90 ED14 D20 M10 L30 Z02-H	20	2	18	10.5	30	19	10	14	SSV M3x8-9508		
MT90 ED14 D25 M12 L35 Z03-H	25	3	21	12.5	35	23	12	14			
MT90 ED14 D32 M16 L43 Z04-H	32	4	29	17	43	23	16	14			



H-İÇTEN SU VERMELİ  
H-WITH COOLANT HOLE



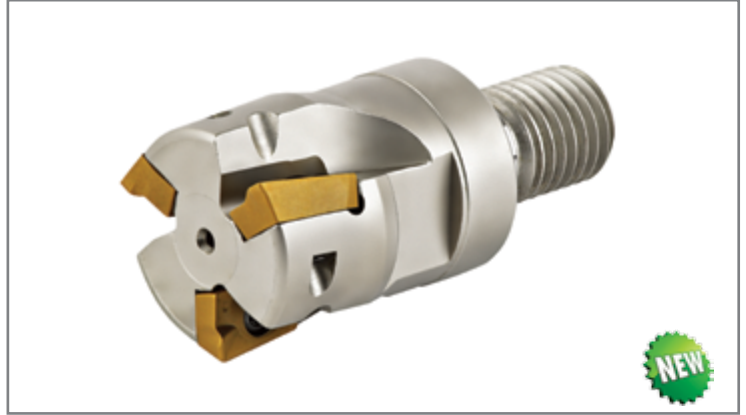
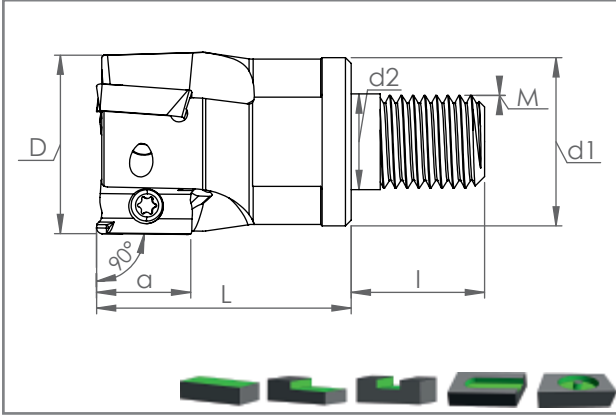

## DEĞİŞTİRİLEBİLİR UCLU MODÜLER FREZELER



Modular End Mills with changeable insert

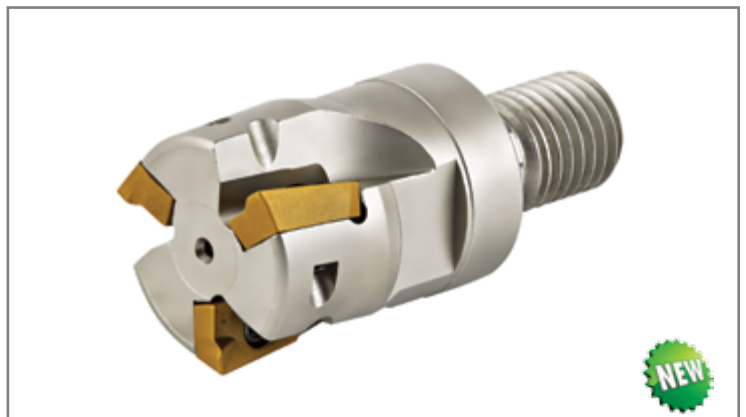
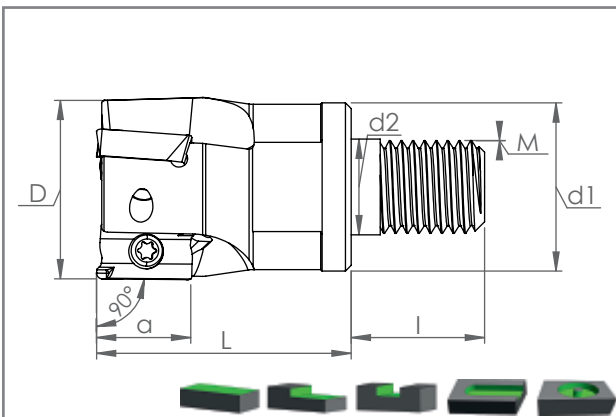

KOD CODE	ÖLÇÜLER DIMENSION (mm)								KESİCİ UÇ INSERT	YEDEK PARÇALAR SPARE PARTS	
	D	Z	d1	d2	L	I	M	a		Sıkma Vidası Clamp Screw	Anahtar Torx Key
<b>MT90 APKT 11T3..</b>											
MT90 APKT11 D16 M08 L25 Z02-H	16	2	15	8.5	25	17	8	11	APKT 11T3.. ZCC-CT UCA UYGUNDUR FOR ZCC-CT INSERT	SSV M2.5x6 9505	T08
MT90 APKT11 D20 M10 L30 Z03-H	20	3	18	10.5	30	19	10	11			
MT90 APKT11 D25 M12 L35 Z04-H	25	4	21	12.5	35	23	12	11			

KOD CODE	ÖLÇÜLER DIMENSION (mm)								KESİCİ UÇ INSERT	YEDEK PARÇALAR SPARE PARTS	
	D	Z	d1	d2	L	I	M	a		Sıkma Vidası Clamp Screw	Anahtar Torx Key
<b>MT90 APMT 1135..</b>											
MT90 APMT11 D16 M08 L25 Z02-H	16	2	15	8.5	25	17	8	11	APMT 1135.. YG-1 UCA UYGUNDUR FOR YG-1 INSERT	SSV M2.5x6 9505	T08
MT90 APMT11 D20 M10 L30 Z03-H	20	3	18	10.5	30	19	10	11			
MT90 APMT11 D25 M12 L35 Z04-H	25	4	21	12.5	35	23	12	11			







KOD CODE	ÖLÇÜLER DIMENSION (mm)								KESİCİ UÇ INSERT	YEDEK PARÇALAR SPARE PARTS	
	D	Z	d1	d2	L	I	M	a		Sıkma Vidası Clamp Screw	Anahtar Torx Key
<b>MT90 APMT 11T3..</b>											
MT90 AP11 D16 M08 L25 Z02-H	16	2	15	8.5	25	17	8	11	APMT 11T3.. KRLY UCA UYGUNDUR FOR KRLY INSERT	SSV M2.5x6 9505	T08
MT90 AP11 D20 M10 L30 Z03-H	20	3	18	10.5	30	19	10	11			
MT90 AP11 D25 M12 L35 Z04-H	25	4	21	12.5	35	23	12	11			

H-İÇTEN SU VERMELİ  
H-WITH COOLANT HOLE

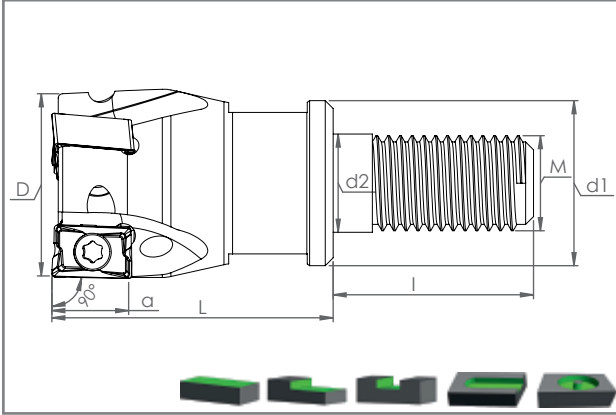

## DEĞİŞTİRİLEBİLİR UCLU MODÜLER FREZELER

### Modular End Mills with changeable insert

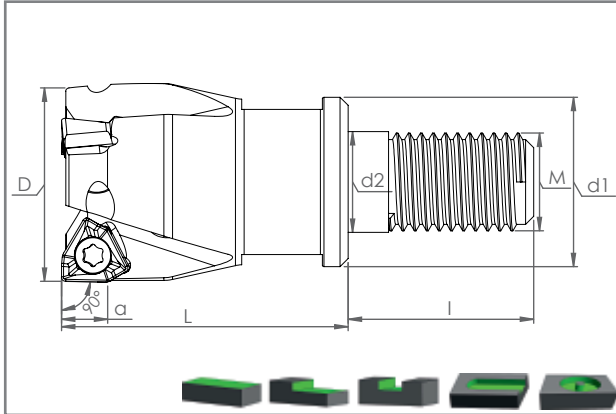

KOD CODE	ÖLÇÜLER DIMENSION (mm)								KESİCİ UÇ INSERT	YEDEK PARÇALAR SPARE PARTS	
	D	Z	d1	d2	L	I	M	a		Sıkma Vidası Clamp Screw	Anahtar Torx Key
<b>MT90 LNEX / LNMX 1006..</b>											
MT90 LN10 D20 M10 L30 Z02-H	20	2	18	10.5	30	19	10	9	LNEX / LNMX 1006.. KRLY UCA UYGUNDUR FOR KRLY INSERT	SSV M3x6-9507	T08
MT90 LN10 D25 M12 L35 Z03-H	25	3	21	12.5	35	23	12	9		SSV M3x8 9508	
MT90 LN10 D32 M16 L43 Z04-H	32	4	29	17	43	23	16	9			





KOD CODE	ÖLÇÜLER DIMENSION (mm)								KESİCİ UÇ INSERT	YEDEK PARÇALAR SPARE PARTS	
	D	Z	d1	d2	L	I	M	a		Sıkma Vidası Clamp Screw	Anahtar Torx Key
<b>MT90 XNKT 0604 / 0805..</b>											
MT90 XNKT06 D20 M10 L30 Z02-H	20	2	18	10.5	30	19	10	6	XNKT 0604.. KRLY UCA UYGUNDUR FOR KRLY INSERT	SSV M3x5-9524	T08
MT90 XNKT06 D25 M12 L35 Z03-H	25	3	21	12.5	35	23	12	6		SSV M3x6-9507	
MT90 XNKT06 D32 M16 L43 Z04-H	32	4	29	17	43	23	16	6			
MT90 XNKT06 D40 M16 L43 Z05-H	40	5	29	17	43	23	16	6	XNKT 0805.. KRLY UCA UYGUNDUR FOR KRLY INSERT	SSV M4x10 9514	T15
MT90 XNKT06 D42 M16 L43 Z05-H	42	5	29	17	43	23	16	6		SSV M4x12-9515	
MT90 XNKT08 D30 M16 L43 Z02-H	30	2	29	17	43	23	16	8			
MT90 XNKT08 D32 M16 L43 Z02-H	32	2	29	17	43	23	16	8			
MT90 XNKT08 D40 M16 L43 Z04-H	40	4	29	17	43	23	16	8			

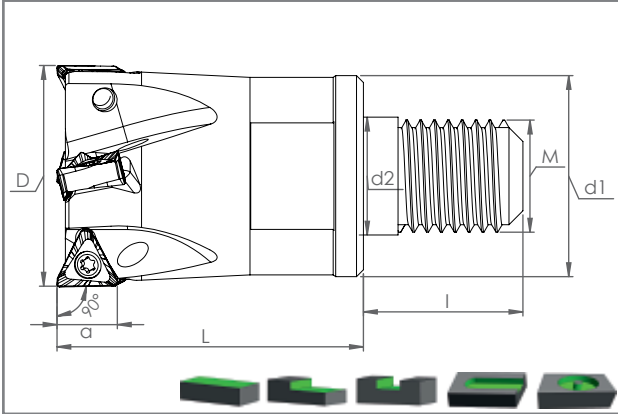

## DEĞİŞTİRİLEBİLİR UCLU MODÜLER FREZELER

Modular End Mills with changeable insert

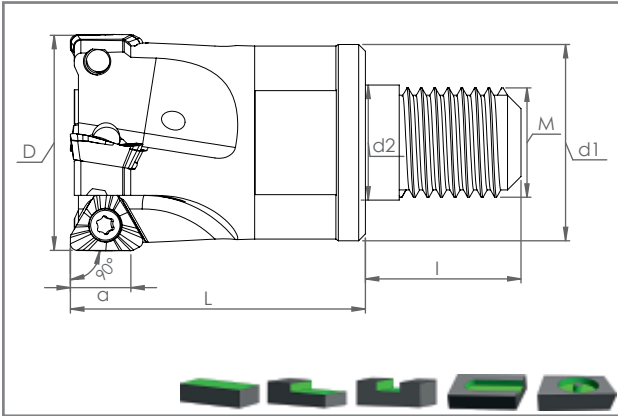

KOD CODE	ÖLÇÜLER DIMENSION (mm)								KESİCİ UÇ INSERT	YEDEK PARÇALAR SPARE PARTS	
	D	Z	d1	d2	L	I	M	a		Sıkma Vidası Clamp Screw	Anahtar Torx Key
<b>MT90 TN.X 1005..</b>											
MT90 TN1005 D20 M10 L30 Z02-H	20	2	18	10,5	30	19	10	5	TN.X 1005.. ISCR UCA UYGUNDUR FOR ISCR INSERT	SSV M3x6 LG- 9509	T08
MT90 TN1005 D25 M12 L35 Z03-H	25	3	21	12,5	35	23	12	5			
MT90 TN1005 D32 M16 L43 Z04-H	32	4	29	17	43	23	16	5			





KOD CODE	ÖLÇÜLER DIMENSION (mm)								KESİCİ UÇ INSERT	YEDEK PARÇALAR SPARE PARTS	
	D	Z	d1	d2	L	I	M	a		Sıkma Vidası Clamp Screw	Anahtar Torx Key
<b>MT90 TP.. 1003..</b>											
MT90 TP10 D25 M12 L35 Z03-H	25	3	21	12.5	35	23	12	8	TP..1003.. ISCR UCA UYGUNDUR FOR ISCR INSERT	SSV M3.5x8 SC 9513	T10
MT90 TP10 D32 M16 L43 Z04-H	32	4	29	17	43	23	16	8			

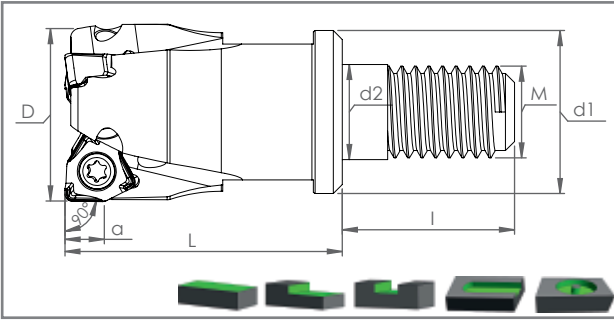

## DEĞİŞTİRİLEBİLİR UCLU MODÜLER FREZELER

Modular End Mills with changeable insert



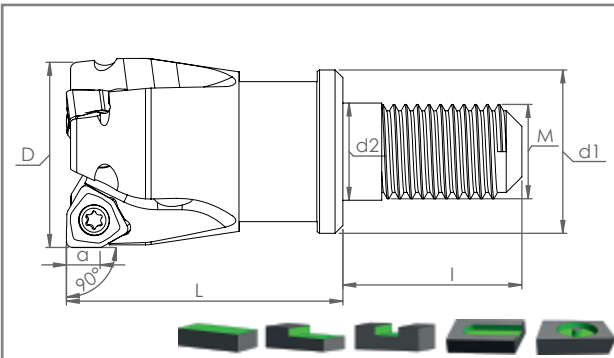

KOD CODE	ÖLÇÜLER DIMENSION (mm)								KESİCİ UÇ INSERT	YEDEK PARÇALAR SPARE PARTS	
	D	Z	d1	d2	L	I	M	a		Sıkma Vidası Clamp Screw	Anahtar Torx Key
<b>MT90 XNEX 0403..</b>											
MT90 XN04 D20 M10 L30 Z03-H	20	3	18	10.5	30	19	10	4	XNEX 0403.. SECO UCA UYGUNDUR FOR SECO INSERT	SSV M2.5x6 9505	T08
MT90 XN04 D25 M12 L35 Z04-H	25	4	21	12.5	35	23	12	4			

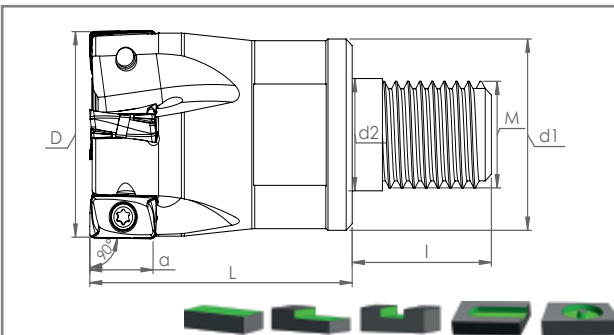

KOD CODE	ÖLÇÜLER DIMENSION (mm)								KESİCİ UÇ INSERT	YEDEK PARÇALAR SPARE PARTS	
	D	Z	d1	d2	L	I	M	a		Sıkma Vidası Clamp Screw	Anahtar Torx Key
<b>MT90 6NKU 0403..</b>											
MT90 6N04 D20 M10 L30 Z02-H	20	2	18	10.5	30	19	10	4.1	6NKU 0403.. TGTC UCA UYGUNDUR FOR TGTC INSERT	SSV M2.5x6 9505	T08
MT90 6N04 D25 M12 L35 Z03-H	25	3	21	12.5	35	23	12	4.1			
MT90 6N04 D32 M16 L43 Z04-H	32	4	29	17	43	23	16	4.1			



KOD CODE	ÖLÇÜLER DIMENSION (mm)								KESİCİ UÇ INSERT	YEDEK PARÇALAR SPARE PARTS	
	D	Z	d1	d2	L	I	M	a		Sıkma Vidası Clamp Screw	Anahtar Torx Key
<b>MT90 LOMU / LOGT 1004..</b>											
MT90 LM10 D16 M08 L25 Z02-H	16	2	15	8.5	25	17	8	10	LOMU / LOGT 1004.. KYCR UCA UYGUNDUR FOR KYCR INSERT	SSV M3x5 LG-9525	T08
MT90 LM10 D20 M10 L30 Z03-H	20	3	18	10.5	30	19	10	10			
MT90 LM10 D25 M12 L35 Z03-H	25	3	21	12.5	35	23	12	10		SSV M3x6 LG 9509	
MT90 LM10 D32 M16 L43 Z04-H	32	4	29	17	43	23	16	10			

## DEĞİŞTİRİLEBİLİR UCLU MODÜLER FREZELER

Modular End Mills with changeable insert

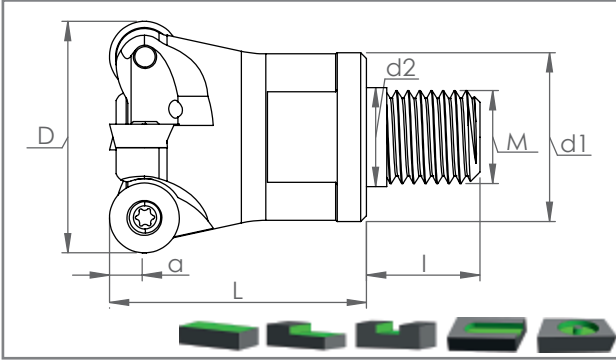

KOD CODE	ÖLÇÜLER DIMENSION (mm)								KESİCİ UÇ INSERT	YEDEK PARÇALAR SPARE PARTS	
	D	Z	d1	d2	L	I	M	a		Sıkma Vidası Clamp Screw	Anahtar Torx Key
<b>MT RPMT 10T3 / 1204..</b>											
MT RP10T3 D20 M10 L30 Z02-H	20	2	18	10.5	30	19	10	5	RPMT 10T3.. MTSBSH UCA UYGUNDUR FOR MTSBSH INSERT	SSV M3.5x10 9511	T15
MT RP10T3 D25 M12 L35 Z03-H	25	3	21	12.5	35	23	12	5			
MT RP10T3 D32 M16 L43 Z04-H	32	4	29	17	43	23	16	5			
MT RP10T3 D35 M16 L43 Z04-H	35	4	29	17	43	23	16	5			
MT RP10T3 D40 M16 L43 Z04-H	40	4	29	17	43	23	16	5			
MT RP10T3 D42 M16 L43 Z05-H	42	5	29	17	43	23	16	5	RPMT 1204.. MTSBSH UCA UYGUNDUR FOR MTSBSH INSERT	SSV M4x10 9514	T15
MT RP1204 D25 M12 L35 Z02-H	25	2	21	12.5	35	23	12	6			
MT RP1204 D32 M16 L43 Z03-H	32	3	29	17	43	23	16	6			
MT RP1204 D35 M16 L43 Z03-H	35	3	29	17	43	23	16	6			
MT RP1204 D40 M16 L43 Z04-H	40	4	29	17	43	23	16	6			
MT RP1204 D42 M16 L43 Z04-H	42	4	29	17	43	23	16	6			

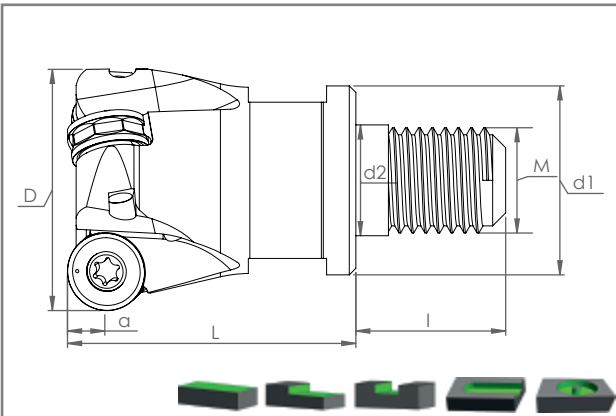

KOD CODE	ÖLÇÜLER DIMENSION (mm)								KESİCİ UÇ INSERT	YEDEK PARÇALAR SPARE PARTS	
	D	Z	d1	d2	L	I	M	a		Sıkma Vidası Clamp Screw	Anahtar Torx Key
<b>MT RNMU 1004 / 1205..</b>											
MT RN10 D25 M12 L35 Z02-H	25	2	21	12.5	35	23	12	5	RNMU 1004.. TGTC UCA UYGUNDUR FOR TGTC INSERT	SSV M3.5x10 9511	T15
MT RN10 D32 M16 L43 Z03-H	32	3	29	17	43	23	16	5			
MT RN12 D32 M16 L43 Z02-H	32	2	29	17	43	23	16	6	RNMU 1205.. TGTC UCA UYGUNDUR FOR TGTC INSERT	SSV M4x10 9514	
MT RN12 D40 M16 L43 Z03-H	40	3	29	17	43	23	16	6			

H-İÇTEN SU VERMELİ  
H-WITH COOLANT HOLE

## DEĞİŞTİRİLEBİLİR UCLU MODÜLER FREZELER

Modular End Mills with changeable insert

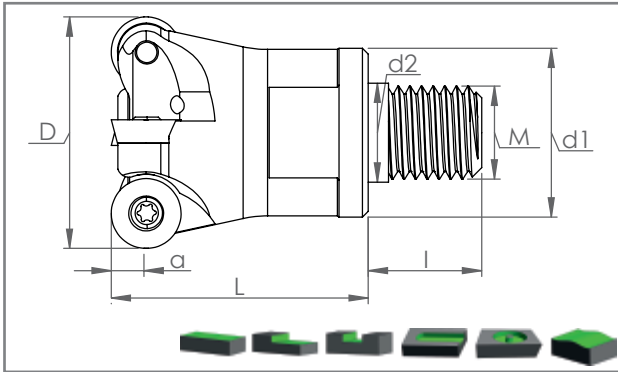

KOD CODE	ÖLÇÜLER DIMENSION (mm)								KESİCİ UÇ INSERT	YEDEK PARÇALAR SPARE PARTS	
	D	Z	d1	d2	L	I	M	a		Sıkma Vidası Clamp Screw	Anahtar Torx Key
<b>MT RDMT</b> <b>0803 / 1003 / 1203..</b> <b>ISO</b>											
MT RD08 D16 M08 L25 Z02-H	16	2	15	8.5	25	17	8	4	RD.. 0803.. ISO UCA UYGUNDUR FOR ISO INSERT	SSV M3x6 9507	T08
MT RD08 D20 M10 L30 Z03-H	20	3	18	10.5	30	19	10	4			
MT RD08 D25 M12 L35 Z04-H	25	4	21	12.5	35	23	12	4			

MT RD10 D20 M10 L30 Z02-H	20	2	18	10.5	30	19	10	5	RD.. 1003.. ISO UCA UYGUNDUR FOR ISO INSERT	SSV M3.5x8 9510	T15
MT RD10 D25 M12 L35 Z03-H	25	3	21	12.5	35	23	12	5			
MT RD10 D30 M16 L43 Z03-H	30	3	29	17	43	23	16	5			
MT RD10 D32 M16 L43 Z04-H	32	4	29	17	43	23	16	5			
MT RD10 D35 M16 L43 Z04-H	35	4	29	17	43	23	16	5			
MT RD10 D40 M16 L43 Z04-H	40	4	29	17	43	23	16	5			
MT RD10 D42 M16 L43 Z05-H	42	5	29	17	43	23	16	5			

MT RD12 D24 M12 L35 Z02-H	24	2	21	12.5	35	23	12	6	RD.. 12T3.. ISO UCA UYGUNDUR FOR ISO INSERT	SSV M3.5x10 9511	T15
MT RD12 D25 M12 L35 Z02-H	25	2	21	12.5	35	23	12	6			
MT RD12 D32 M16 L43 Z03-H	32	3	29	17	43	23	16	6			
MT RD12 D35 M16 L43 Z03-H	35	3	29	17	43	23	16	6			
MT RD12 D40 M16 L43 Z04-H	40	4	29	17	43	23	16	6			
MT RD12 D42 M16 L43 Z04-H	42	4	29	17	43	23	16	6			

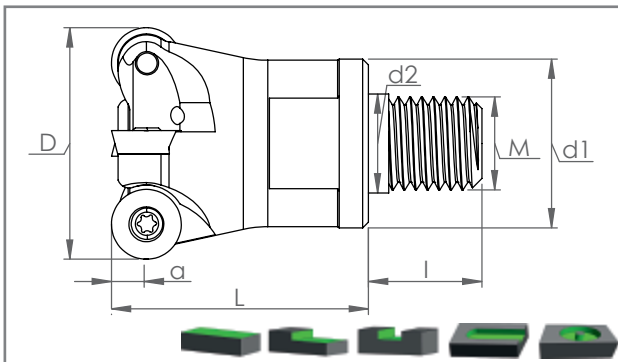



KOD CODE	ÖLÇÜLER DIMENSION (mm)								KESİCİ UÇ INSERT	YEDEK PARÇALAR SPARE PARTS	
	D	Z	d1	d2	L	I	M	a		Sıkma Vidası Clamp Screw	Anahtar Torx Key
<b>MT RPMT / RPGT</b> <b>10T3 / 1204..</b>											
MT RPMT10 D25 M12 L35 Z02-H	25	2	21	12.5	35	23	12	5	RPMT / RPGT10T3.. KYCR UCA UYGUNDUR FOR KYCR INSERT	SSV M3X8 9508	T08
MT RPMT10 D32 M16 L43 Z03-H	32	3	29	17	43	23	16	5			
MT RPMT12 D32 M16 L43 Z03-H	32	3	29	17	43	23	16	6	RPMT / RPGT10T3.. KYCR UCA UYGUNDUR FOR KYCR INSERT	SSV M4X10 9511	T15
MT RPMT12 D40 M16 L43 Z04-H	40	4	29	17	43	23	16	6			

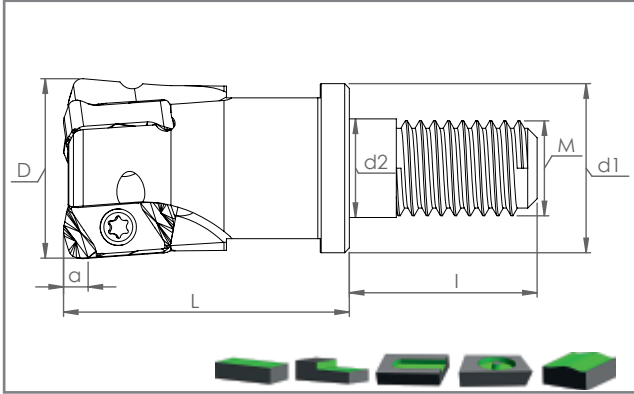

## HIZLI İLERLEMELİ MODÜLER FREZELER

### High Feed Modular End Mills

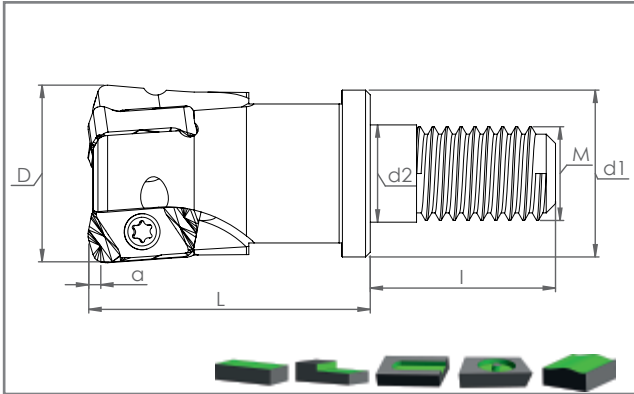

KOD CODE	ÖLÇÜLER DIMENSION (mm)								KESİCİ UÇ INSERT	YEDEK PARÇALAR SPARE PARTS	
	D	Z	d1	d2	L	I	M	a		Sıkma Vidası Clamp Screw	Anahtar Torx Key
<b>MHT LNMU 0303..</b>											
MHT LN03 D16 M08 L25 Z02-H	16	2	15	8.5	25	17	8	1	<b>LNMU 0303.. TNGLY UCA UYGUNDUR FOR TNGLY INSERT</b>	<b>SSV M2.5x6-9505</b>	<b>T08</b>
MHT LN03 D20 M10 L30 Z03-H	20	3	18	10.5	30	19	10	1			
MHT LN03 D25 M12 L35 Z04-H	25	4	21	12.5	35	23	12	1			
MHT LN03 D32 M16 L43 Z05-H	32	5	29	17	43	23	16	1			
MHT LN03 D40 M16 L43 Z06-H	40	6	29	17	43	23	16	1			

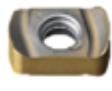

KOD CODE	ÖLÇÜLER DIMENSION (mm)								KESİCİ UÇ INSERT	YEDEK PARÇALAR SPARE PARTS	
	D	Z	d1	d2	L	I	M	a		Sıkma Vidası Clamp Screw	Anahtar Torx Key
<b>MHT ENMU 1004..</b>											
MHT EN10 D16 M08 L25 Z02-H	16	2	15	8.5	25	17	8	1.7	<b>ENMU 1004.. DJT UCA UYGUNDUR FOR DJT INSERT</b>	<b>SSV M2.5x6-9505</b>	<b>T08</b>
MHT EN10 D20 M10 L30 Z03-H	20	3	18	10.5	30	19	10	1.7			
MHT EN10 D25 M12 L35 Z04-H	25	4	21	12.5	35	23	12	1.7		<b>SSV M2.5x7-9506</b>	

## HIZLI İLERLEMELİ MODÜLER FREZELER

### High Feed Modular End Mills

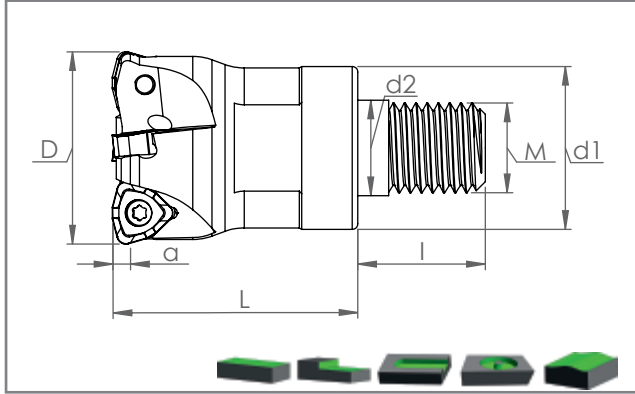

KOD CODE	ÖLÇÜLER DIMENSION (mm)								KESİCİ UÇ INSERT	YEDEK PARÇALAR SPARE PARTS	
	D	Z	d1	d2	L	I	M	a		Sıkma Vidası Clamp Screw	Anahtar Torx Key
<b>MHT WNMX 0603 / 09T3..</b>											
MHT WN0603 D16 M08 L25 Z02-H	16	2	15	8.5	25	17	8	1	WNMX 0603.. KRLY UCA UYGUNDUR FOR KRLY INSERT	SSV M2.5x6-9505	T08
MHT WN0603 D20 M10 L30 Z02-H	20	2	18	10.5	30	19	10	1			
MHT WN0603 D25 M12 L35 Z03-H	25	3	21	12.5	35	23	12	1			
MHT WN0603 D32 M16 L43 Z04-H	32	4	29	17	43	23	16	1			
MHT WN09T3 D25 M12 L35 Z02-H	25	2	21	12.5	35	23	12	1.5	WNMX 09T3.. KRLY UCA UYGUNDUR FOR KRLY INSERT	SSV M3x8 9508	T08
MHT WN09T3 D32 M16 L43 Z03-H	32	3	29	17	43	23	16	1.5			
MHT WN09T3 D35 M16 L43 Z04-H	35	4	29	17	43	23	16	1.5			
MHT WN09T3 D40 M16 L43 Z04-H	40	4	29	17	43	23	16	1.5			
MHT WN09T3 D42 M16 L43 Z04-H	42	4	29	17	43	23	16	1.5			

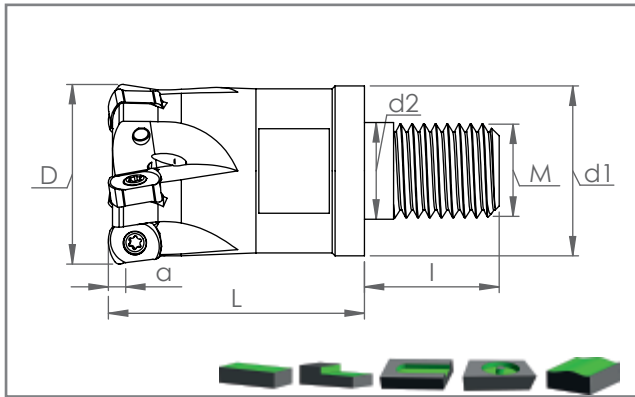



KOD CODE	ÖLÇÜLER DIMENSION (mm)								KESİCİ UÇ INSERT	YEDEK PARÇALAR SPARE PARTS	
	D	Z	d1	d2	L	I	M	a		Sıkma Vidası Clamp Screw	Anahtar Torx Key
<b>MHT BLMP 0603..</b>											
MHT BL06 D16 M08 L25 Z02-H	16	2	15	8.5	25	17	8	0.7	BLMP 0603.. TGTC UCA UYGUNDUR FOR TGTC INSERT	SSV M2.5x6 9505	T08
MHT BL06 D20 M10 L30 Z03-H	20	3	18	10.5	30	19	10	1			
MHT BL06 D25 M12 L35 Z04-H	25	4	21	12.5	35	23	12	1			
MHT BL06 D32 M16 L43 Z05-H	32	5	29	17	43	23	16	1			
MHT BL06 D35 M16 L43 Z05-H	35	5	29	17	43	23	16	1			



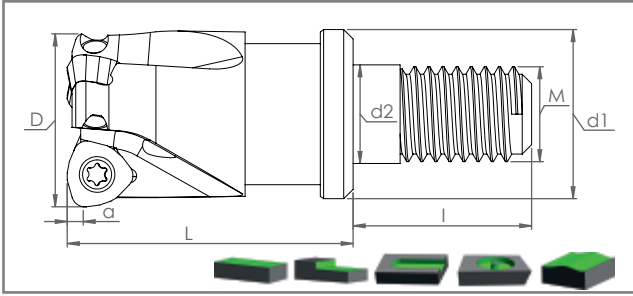

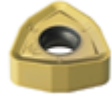
## HIZLI İLERLEMELİ MODÜLER FREZELER High Feed Modular End Mills



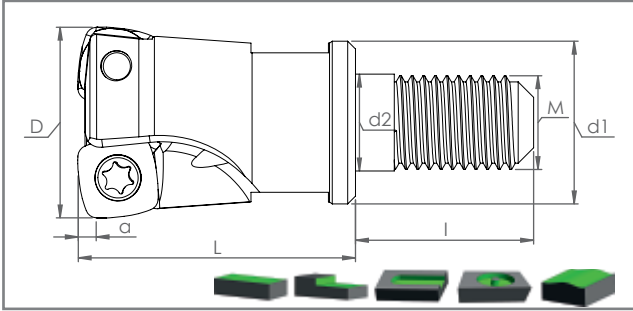

KOD CODE	ÖLÇÜLER DIMENSION (mm)								KESİCİ UÇ INSERT	YEDEK PARÇALAR SPARE PARTS	
	D	Z	d1	d2	L	I	M	a		Sıkma Vidası Clamp Screw	Anahtar Torx Key
<b>MHT WOM. 04T2..</b>											
MHT WO04 D16 M08 L25 Z02-H	16	2	15	8.5	25	17	8	1.2	WOM. 04T2.. DJT UCA UYGUNDUR FOR DJT INSERT	SSV M2.5x6-9505	T08
MHT WO04 D20 M10 L30 Z03-H	20	3	18	10.5	30	19	10	1.2			

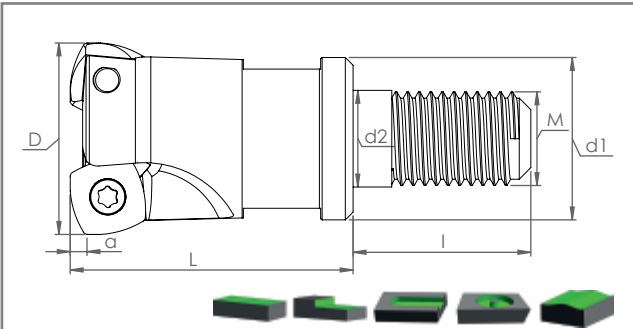

KOD CODE	ÖLÇÜLER DIMENSION (mm)								KESİCİ UÇ INSERT	YEDEK PARÇALAR SPARE PARTS	
	D	Z	d1	d2	L	I	M	a		Sıkma Vidası Clamp Screw	Anahtar Torx Key
<b>MHT SPNW / SPET / SPMT 1004..</b>											
MHT SP10 D25 M12 L35 Z02-H	25	2	21	12.5	35	23	12	1.6	SPNW / SPET / SPMT 1004.. DJT UCA UYGUNDUR FOR DJT INSERT	SSV M3.5x8-9510	T15
MHT SP10 D32 M16 L43 Z03-H	32	3	29	17	43	23	16	1.6			



KOD CODE	ÖLÇÜLER DIMENSION (mm)								KESİCİ UÇ INSERT	YEDEK PARÇALAR SPARE PARTS	
	D	Z	d1	d2	L	I	M	a		Sıkma Vidası Clamp Screw	Anahtar Torx Key
<b>MHT ZDCW 09T3..</b>											
MHT ZD09 D25 M12 L35 Z02-H	25	2	21	12.5	35	23	12	1.3	ZDCW 09T3.. PRMT UCA UYGUNDUR FOR PRMT INSERT	SSV M3x8-9508	T08
MHT ZD09 D32 M16 L43 Z03-H	32	3	29	17	43	23	16	1.3			
MHT ZD09 D35 M16 L43 Z03-H	35	3	29	17	43	23	16	1.3			

H-İÇTEN SU VERMELİ  
H-WITH COOLANT HOLE

## HIZLI İLERLEMELİ MODÜLER FREZELER

### High Feed Modular End Mills

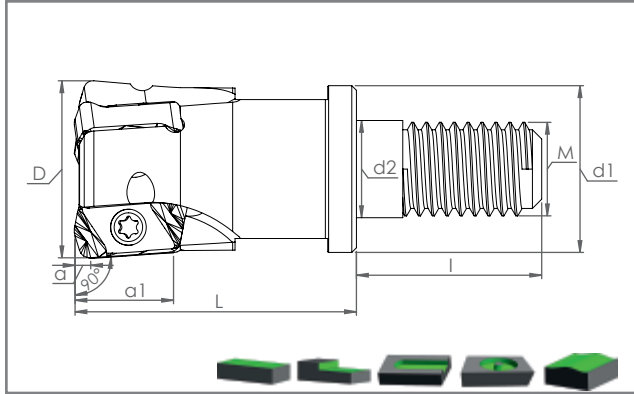

KOD CODE	ÖLÇÜLER DIMENSION (mm)									KESİCİ UÇ INSERT	YEDEK PARÇALAR SPARE PARTS	
	D	Z	d1	d2	L	I	M	a	a1 (90°)		Sıkma Vidası Clamp Screw	Anahtar Torx Key
<b>MHT ZPMT / YPHW / EP. 1003..</b>												
MHT(90) ZP10 D16 M08 L25 Z02-H	16	2	15	8.5	25	17	8	1	9	ZPMT / YPHW / EP. 1003.. DJT UCA UYGUNDUR FOR DJT INSERT		T08
MHT(90) ZP10 D20 M10 L30 Z03-H	20	3	18	10.5	30	19	10	1	9			
MHT(90) ZP10 D25 M12 L35 Z04-H	25	4	21	12.5	35	23	12	1	9			

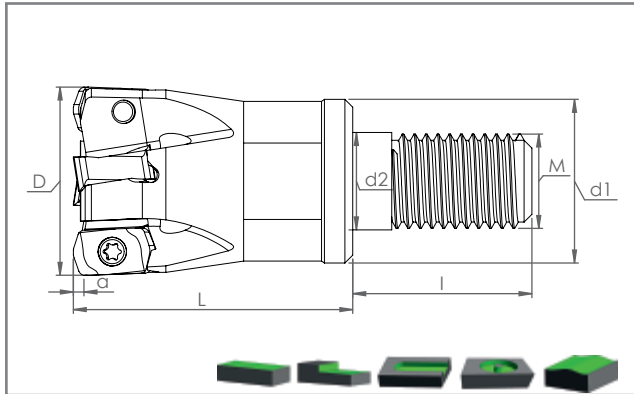



KOD CODE	ÖLÇÜLER DIMENSION (mm)									KESİCİ UÇ INSERT	YEDEK PARÇALAR SPARE PARTS	
	D	Z	d1	d2	L	I	M	a	Sıkma Vidası Clamp Screw		Anahtar Torx Key	
<b>MHT BNGX 10T3..</b>												
MHT BN10 D16 M08 L25 Z02-H	16	2	15	8.5	25	17	8	1		BNGX 10T3.. PRMT UCA UYGUNDUR FOR PRMT INSERT		T08
MHT BN10 D20 M10 L30 Z03-H	20	3	18	10.5	30	19	10	1				
MHT BN10 D25 M12 L35 Z04-H	25	4	21	12.5	35	23	12	1				
MHT BN10 D32 M16 L43 Z05-H	32	5	29	17	43	23	16	1				

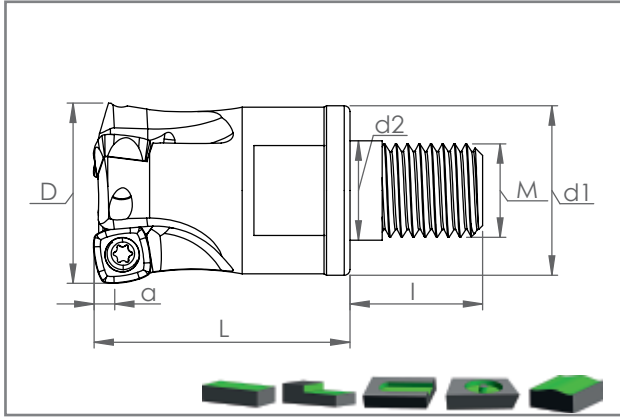

## HIZLI İLERLEMELİ MODÜLER FREZELER

### High Feed Modular End Mills

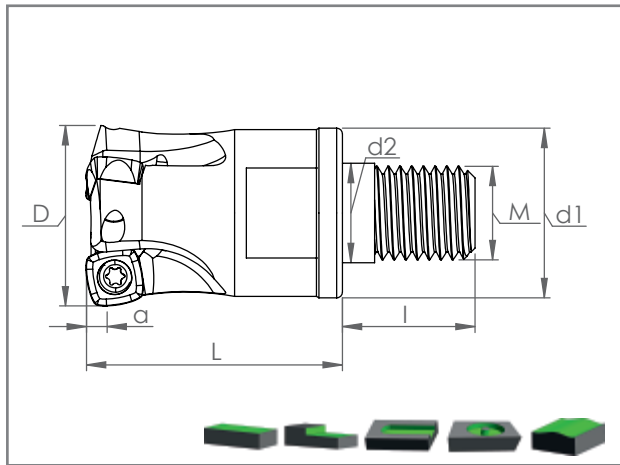

KOD CODE	ÖLÇÜLER DIMENSION (mm)								KESİCİ UÇ INSERT	YEDEK PARÇALAR SPARE PARTS	
	D	Z	d1	d2	L	I	M	a		Sıkma Vidası Clamp Screw	Anahtar Torx Key
<b>MT90 XPLX 0603..</b>											
MHT XP06 D16 M08 L25 Z02-H	16	2	15	8.5	25	17	8	1	XPLX 0603.. CRTZT UCA UYGUNDUR FOR CRTZT INSERT	SSV M2.5x6 9505	T08
MHT XP06 D20 M10 L30 Z03-H	20	3	18	10.5	30	19	10	1			
MHT XP06 D22 M10 L30 Z03-H	22	3	18	10.5	30	19	10	1			



KOD CODE	ÖLÇÜLER DIMENSION (mm)								KESİCİ UÇ INSERT	YEDEK PARÇALAR SPARE PARTS	
	D	Z	d1	d2	L	I	M	a		Sıkma Vidası Clamp Screw	Anahtar Torx Key
<b>MT90 XDLX 09T3..</b>											
MHT XD09 D25 M12 L35 Z02-H	25	2	21	12.5	35	23	12	1.2	XDLX 09T3.. CRTZT UCA UYGUNDUR FOR CRTZT	SSV M3.5x8-9510	T15
MHT XD09 D32 M16 L43 Z03-H	32	3	29	17	43	23	16	1.2			
MHT XD09 D35 M16 L43 Z03-H	35	3	29	17	43	23	16	1.2			
MHT XD09 D40 M16 L43 Z04-H	40	4	29	17	43	23	16	1.2			
MHT XD09 D42 M16 L43 Z04-H	42	4	29	17	43	23	16	1.2		SSV M3.5x10 9511	

## HIZLI İLERLEMELİ MODÜLER FREZELER

### High Feed Modular End Mills

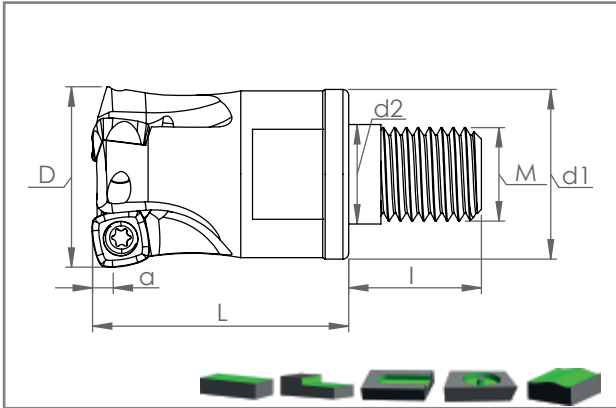



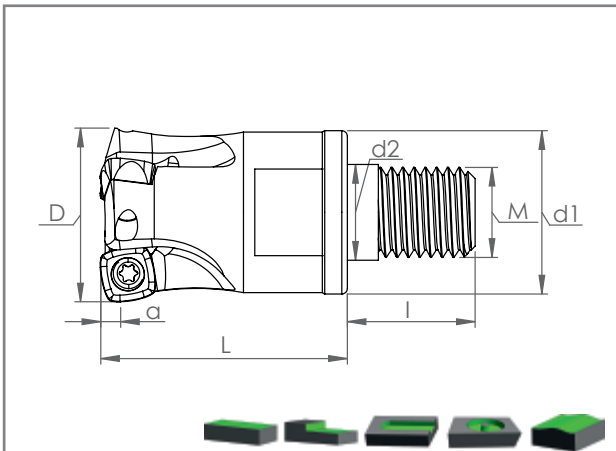

KOD CODE	ÖLÇÜLER DIMENSION (mm)								KESİCİ UÇ INSERT	YEDEK PARÇALAR SPARE PARTS	
	D	Z	d1	d2	L	I	M	a		Sıkma Vidası Clamp Screw	Anahtar Torx Key
<b>MHT SDMT 09T3..</b>											
MHT SDMT09 D25 M12 L35 Z02-H	25	2	21	12.5	35	23	12	1.5	SDMT 09T3.. ZCC-CT UCA UYGUNDUR FOR ZCC-CT INSERT	SSV M3.5x8 SC 9513	T10
MHT SDMT09 D32 M16 L43 Z03-H	32	3	29	17	43	23	16	1.5			
MHT SDMT09 D35 M16 L43 Z04-H	35	4	29	17	43	23	16	1.5			
MHT SDMT09 D40 M16 L43 Z04-H	40	4	29	17	43	23	16	1.5			



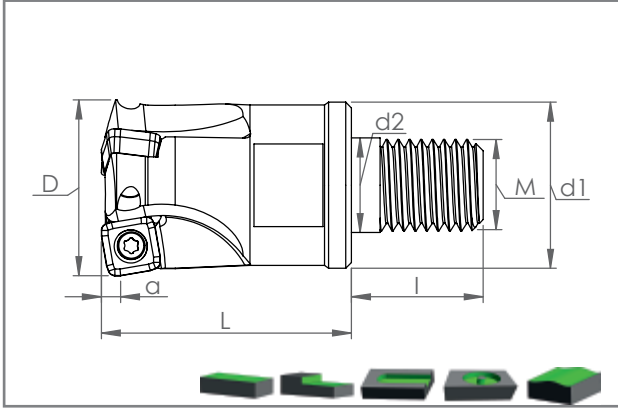



KOD CODE	ÖLÇÜLER DIMENSION (mm)								KESİCİ UÇ INSERT	YEDEK PARÇALAR SPARE PARTS	
	D	Z	d1	d2	L	I	M	a		Sıkma Vidası Clamp Screw	Anahtar Torx Key
<b>MHT SDKX 0904..</b>											
MHT SDKX09 D25 M12 L35 Z02-H	25	2	21	12.5	35	23	12	1.5	SDKX 0904.. LAMINA UCA UYGUNDUR FOR LAMINA INSERT	SSV M3.5x8 SC 9513	T10
MHT SDKX09 D32 M16 L43 Z03-H	32	3	29	17	43	23	16	1.5			
MHT SDKX09 D35 M16 L43 Z04-H	35	4	29	17	43	23	16	1.5			
MHT SDKX09 D40 M16 L43 Z04-H	40	4	29	17	43	23	16	1.5			

## HIZLI İLERLEMELİ MODÜLER FREZELER High Feed Modular End Mills

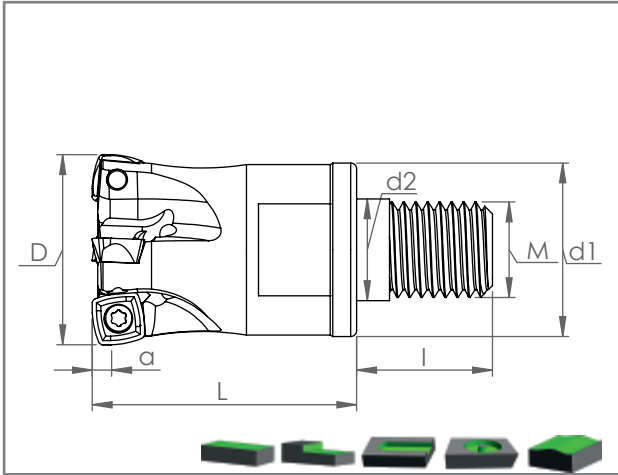

KOD CODE	ÖLÇÜLER DIMENSION (mm)								KESİCİ UÇ INSERT	YEDEK PARÇALAR SPARE PARTS	
	D	Z	d1	d2	L	I	M	a		Sıkma Vidası Clamp Screw	Anahtar Torx Key
<b>MHT R210.09..</b>											
MHT R210.09 D25 M12 L35 Z02-H	25	2	21	12.5	35	23	12	1.2	<b>R210.09.. SDVK UCA UYGUNDUR FOR SDVK INSERT</b>	<b>SSV M3.5x8-9510</b>	<b>T15</b>
MHT R210.09 D32 M16 L43 Z03-H	32	3	29	17	43	23	16	1.2			
MHT R210.09 D35 M16 L43 Z03-H	35	3	29	17	43	23	16	1.2			





KOD CODE	ÖLÇÜLER DIMENSION (mm)								KESİCİ UÇ INSERT	YEDEK PARÇALAR SPARE PARTS	
	D	Z	d1	d2	L	I	M	a		Sıkma Vidası Clamp Screw	Anahtar Torx Key
<b>MHT SPKT 08T3..</b>											
MHT SPKT08 D25 M12 L35 Z03-H	25	3	21	12.5	35	23	12	1.5	<b>SPKT 08T3.. PALBIT UCA UYGUNDUR FOR PALBIT INSERT</b>	<b>SSV M3x6-9507</b>	<b>T08</b>
MHT SPKT08 D32 M16 L43 Z04-H	32	4	29	17	43	23	16	1.5			
MHT SPKT08 D35 M16 L43 Z04-H	35	4	29	17	43	23	16	1.5			
MHT SPKT08 D42 M16 L43 Z05-H	42	5	29	17	43	23	16	1.5			

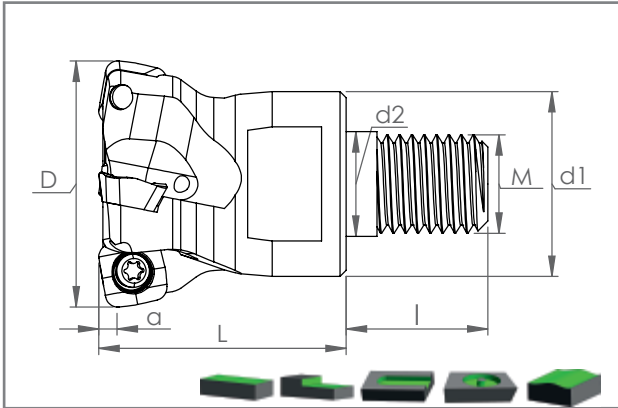

## HIZLI İLERLEMELİ MODÜLER FREZELER

### High Feed Modular End Mills



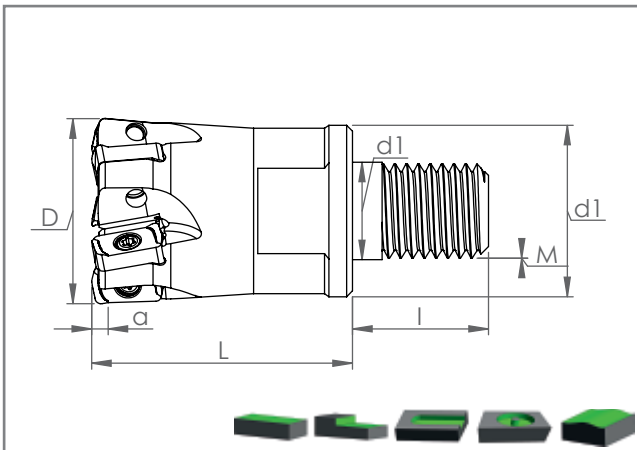



KOD CODE	ÖLÇÜLER DIMENSION (mm)								KESİCİ UÇ INSERT	YEDEK PARÇALAR SPARE PARTS	
	D	Z	d1	d2	L	I	M	a		Sıkma Vidası Clamp Screw	Anahtar Torx Key
<b>MHT SOMT 1004..</b>											
MHT SO10 D32 M16 L43 Z03-H	32	3	29	17	43	23	16	1.2	SOMT 1004.. KYCR UCA UYGUNDUR FOR KYCR INSERT	SSV M4x10 9514	T15
MHT SO10 D35 M16 L43 Z03-H	35	3	29	17	43	23	16	1.2			
MHT SO10 D40 M16 L43 Z04-H	40	4	29	17	43	23	16	1.2			
MHT SO10 D42 M16 L43 Z04-H	42	4	29	17	43	23	16	1.2			



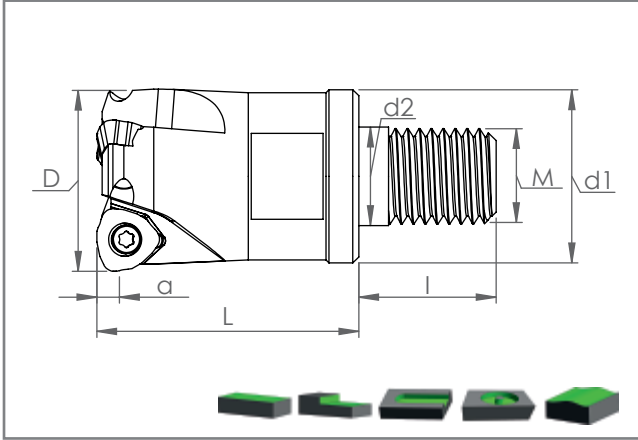



KOD CODE	ÖLÇÜLER DIMENSION (mm)								KESİCİ UÇ INSERT	YEDEK PARÇALAR SPARE PARTS	
	D	Z	d1	d2	L	I	M	a		Sıkma Vidası Clamp Screw	Anahtar Torx Key
<b>MHT LOGU 0303..</b>											
MHT LG03 D16 M08 L25 Z02-H	16	2	15	8.5	25	17	8	1	LOGU 0303.. KYCR UCA UYGUNDUR FOR KYCR INSERT	SSV M3x6 LG 9509	T08
MHT LG03 D20 M10 L30 Z03-H	20	3	18	10.5	30	19	10	1			
MHT LG03 D25 M12 L35 Z04-H	25	4	21	12.5	35	23	12	1			
MHT LG03 D32 M16 L43 Z05-H	32	5	29	17	43	23	16	1			
MHT LG03 D35 M16 L43 Z05-H	35	5	29	17	43	23	16	1			

## HIZLI İLERLEMELİ MODÜLER FREZELER High Feed Modular End Mills

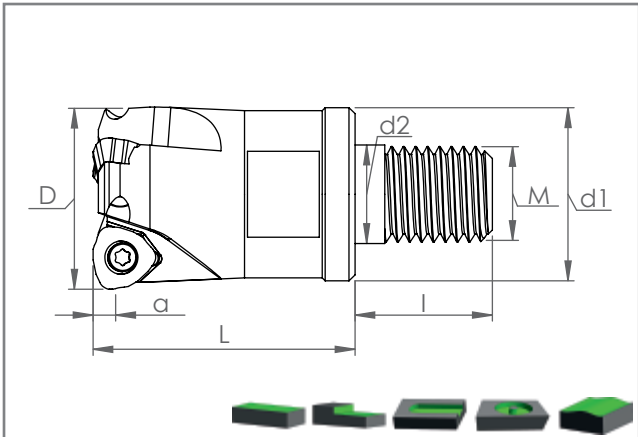

KOD CODE	ÖLÇÜLER DIMENSION (mm)								KESİCİ UÇ INSERT	YEDEK PARÇALAR SPARE PARTS	
	D	Z	d1	d2	L	I	M	a		Sıkma Vidası Clamp Screw	Anahtar Torx Key
<b>MHT JDM. 09T3..</b>											
MHT JD09 D25 M12 L35 Z02-H	25	2	21	12.5	35	23	12	1.5	JDM. 09T3.. MTSBSH UCA UYGUNDUR FOR MTSBSH INSERT	SSV M4x10 9514	T15
MHT JD09 D32 M16 L43 Z03-H	32	3	29	17	43	23	16	1.5			
MHT JD09 D35 M16 L43 Z03-H	35	3	29	17	43	23	16	1.5			





KOD CODE	ÖLÇÜLER DIMENSION (mm)								KESİCİ UÇ INSERT	YEDEK PARÇALAR SPARE PARTS	
	D	Z	d1	d2	L	I	M	a		Sıkma Vidası Clamp Screw	Anahtar Torx Key
<b>MHT JOM. 0803..</b>											
MHT JO08 D25 M12 L35 Z03-H	25	3	21	12.5	35	23	12	0.8	JOM. 0803.. MTSBSH UCA UYGUNDUR FOR MTSBSH	SSV M3x8-9508	T08
MHT JO08 D32 M16 L43 Z04-H	32	4	29	17	43	23	16	0.8			
MHT JO08 D35 M16 L43 Z04-H	35	4	29	17	43	23	16	0.8			

## HIZLI İLERLEMELİ MODÜLER FREZELER

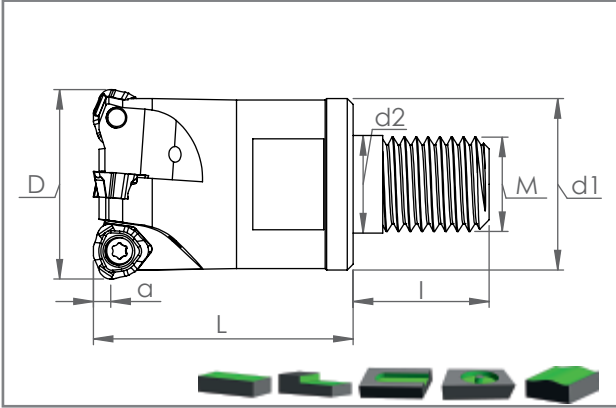
### High Feed Modular End Mills



KOD CODE	ÖLÇÜLER DIMENSION (mm)								KESİCİ UÇ INSERT	YEDEK PARÇALAR SPARE PARTS	
	D	Z	d1	d2	L	I	M	a		Sıkma Vidası Clamp Screw	Anahtar Torx Key
<b>MHT WDMT 0804..</b>											
MHT WD08 D25 M12 L35 Z02-H	25	2	21	12.5	35	23	12	1.5	WDMT 0804.. SMTM UCA UYGUNDUR FOR SMTM	SSV M3x8-9508	T08
MHT WD08 D32 M16 L43 Z04-H	32	4	29	17	43	23	16	1.5			
MHT WD08 D35 M16 L43 Z04-H	35	4	29	17	43	23	16	1.5			

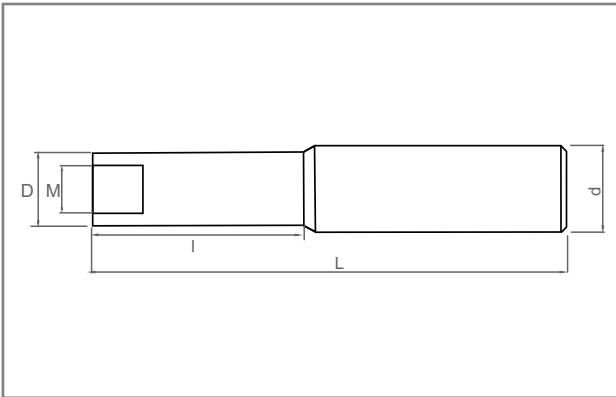





KOD CODE	ÖLÇÜLER DIMENSION (mm)				
SMVT	D	d	M	L	I
SMVT D15 C16 M08 L120-H	15	16	8	120	40
SMVT D18 C20 M10 L120-H	18	20	10	120	60
SMVT D18 C20 M10 L170-H	18	20	10	170	90
SMVT D24 C25 M12 L160-H	24	25	12	160	80
SMVT D24 C25 M12 L200-H	24	25	12	200	100
SMVT D24 C25 M12 L250-H	24	25	12	250	150
SMVT D31 C32 M16 L160-H	31	32	16	160	80
SMVT D31 C32 M16 L200-H	31	32	16	200	100
SMVT D31 C32 M16 L250-H	31	32	16	250	150

H-İÇTEN SU VERMELİ  
H-WITH COOLANT HOLE

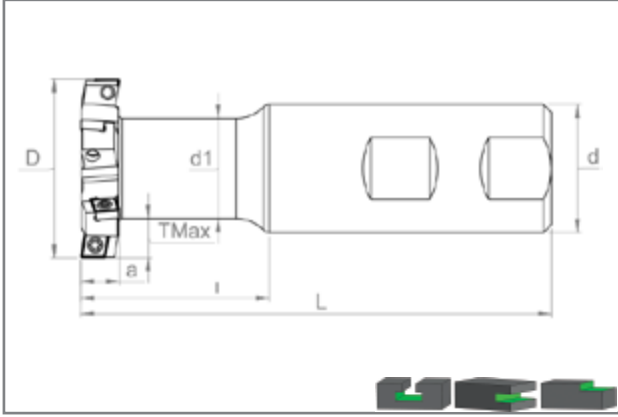

## T KANAL FREZELER T Slot Mills





KOD CODE	ÖLÇÜLER DIMENSION (mm)								KESİCİ UÇ INSERT	YEDEK PARÇALAR SPARE PARTS	
	D	d	d1	L	l	Z	a	T <sub>max</sub>		Sıkma Vidası Clamp Screw	Anahtar Torx Key
<b>TF90 T FREZELER T SLOT MILLS-ISO</b>											
TF90 CC06 D17x8 W16 L100 Z02 T3.5	17	16	10	120	25	2	8	3.5	CC..0602.. ISO	SSV M2.5x6 9505	T08
TF90 CC06 D20x9 W16 L120 Z02 T5	20	16	10	120	25	2	9	5			
TF90 CC06 D23x10 W20 L120 Z04 T3.5	23	20	16	120	40	4	10	3.5			
TF90 CC06 D25x10 W20 L120 Z04 T4.5	25	20	16	120	40	4	10	4.5			
TF90 CC06 D26x11 W20 L120 Z04 T5	26	20	16	120	40	4	11	5			
TF90 CC06 D30x12 W25 L120 Z04 T6	30	25	18	120	45	4	12	6			
TF90 CC06 D32x12 W25 L120 Z04 T6	32	25	20	120	45	4	12	6			
TF90 CC06 D35x12 W25 L120 Z04 T7.5	35	25	20	120	45	4	12	7.5			
TF90 CC06 D40x12 W25 L120 Z06 T9	40	25	22	120	40	6	12	9			
TF90 CC06 D42x12 W25 L120 Z06 T10	42	25	22	120	45	6	12	10			
TF90 CC06 D45x8 W32 L120 Z06 T10	45	32	25	120	45	6	8	10			
TF90 CC06 D45x10 W32 L120 Z06 T10	45	32	25	120	45	6	10	10			
TF90 CC06 D50x8 W32 L120 Z06 T12.5	50	32	25	120	45	6	8	12.5			
TF90 CC06 D50x10 W32 L120 Z06 T12.5	50	32	25	120	45	6	10	12.5			
TF90 CC06 D55x8 W32 L120 Z08 T15	55	32	25	120	45	8	8	15			
TF90 CC06 D55x10 W32 L120 Z08 T15	55	32	25	120	45	8	10	15			
TF90 CC06 D60x8 W32 L120 Z08 T17.5	60	32	25	120	45	8	8	17.5			
TF90 CC06 D60x10 W32 L120 Z08 T17.5	60	32	25	120	45	8	10	17.5			
TF90 CC09 D35x14 W25 L120 Z04 T5	35	32	25	120	45	4	14	5	CC..09T3.. ISO	SSV M3.5x10 9511	T15
TF90 CC09 D42x14 W32 L120 Z04 T11	42	32	20	120	45	4	14	11			
TF90 CC09 D45x14 W32 L120 Z04 T10	45	32	25	120	45	4	14	10			
TF90 CC12 D47x20 W32 L120 Z04 T11	47	32	25	120	55	4	20	11	CC..1204.. ISO	SSV M4x10-9514	



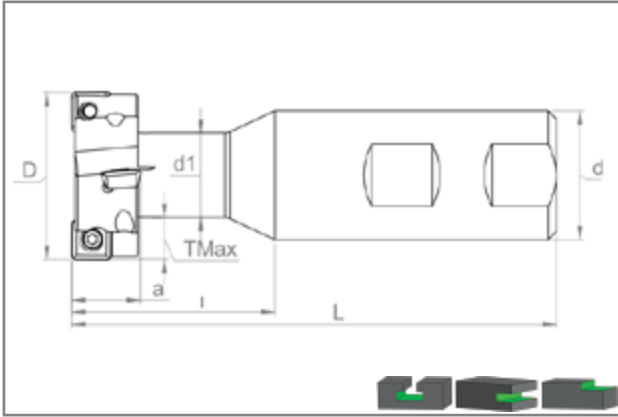

## T KANAL FREZELER

### T Slot Mills

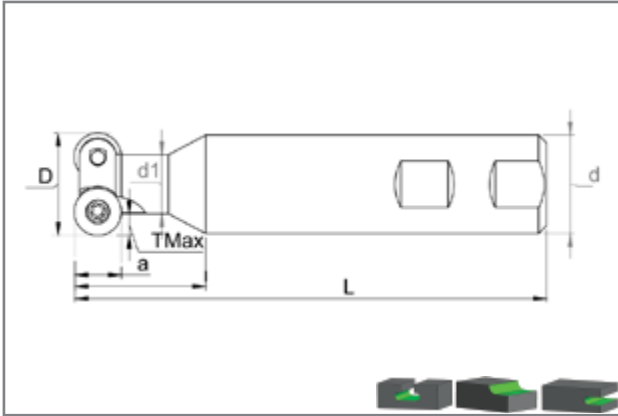

KOD CODE	ÖLÇÜLER DIMENSION (mm)								KESİCİ UÇ INSERT	YEDEK PARÇALAR SPARE PARTS	
	D	d	d1	L	l	Z	a	T <sub>max</sub>		Sıkma Vidası Clamp Screw	Anahtar Torx Key
<b>TF90 T FREZELER T SLOT MILLS</b>											
TF90 SP09 D37x16 W32 L120 Z04 T7.5	37	32	21	120	45	4	16	7.5	SPMG 0904.. TGTC UCA UYGUNDUR FOR TGTC INSERT	 SSV M3.5x10 9511	 T15
TF90 SP09 D42x17 W32 L120 Z04 T10.5	42	32	21	120	45	4	17	10.5			
TF90 SP11 D47x20 W32 L120 Z04 T11.5	47	32	24	120	50	4	20	11.5	SPMG 1104.. TGTC UCA UYGUNDUR FOR TGTC INSERT	SSV M4x10-9514	



KOD CODE	ÖLÇÜLER DIMENSION (mm)								KESİCİ UÇ INSERT	YEDEK PARÇALAR SPARE PARTS	
	D	d	d1	l	L	Z	a	T <sub>max</sub>		Sıkma Vidası Clamp Screw	Anahtar Torx Key
<b>T FREZELER T SLOT MILLS-ISO</b>											
TF RD0702 D17 W16 L120 Z02 T3.5	17	16	10	15	120	2	7	3.5	RD..0702 ISO	 SSV M2.5x6 9505	 T08
TF RD0702 D25 W16 L120 Z02 T5	25	16	15	12	120	2	7	5			
TF RD0702 D35 W25 L120 Z05 T7.5	35	25	20	25	120	5	7	7.5		SSV M2.5x7 9506	
TF RD1003 D21 W25 L120 Z02 T4.5	21	25	12	30	120	2	10	4.5	RD..1003 ISO	 SSV M3.5x10 9511	 T15
TF RD12T3 D26 W25 L120 Z02 T5.5	26	25	15	30	120	2	12	5.5	RD..12T3 ISO		
TF RD1604 D34 W32 L120 Z02 T7	34	32	20	40	120	2	16	7	RD..1604 ISO	SSV M4x10-9514	

## DAİRE KANAL FREZELER

### Disc Mills

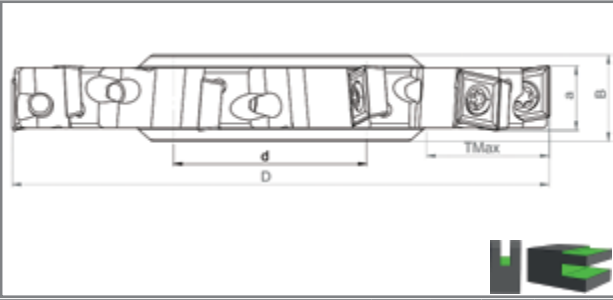

KOD CODE	ÖLÇÜLER DIMENSION (mm)						KESİCİ UÇ INSERT	YEDEK PARÇALAR SPARE PARTS	
	D	a	d	B	Z	T <sub>max</sub>		Sıkma Vidası Clamp Screw	Anahtar Torx Key
<b>BSDF DISK FREZELER DISC MILLING - ISO</b>									
BSDF CC06 D60x8 d22 Z08 T14	60	8	22	12	8	14	CC..0602.. ISO	SSV M2.5x7 9506	T08
BSDF CC06 D80x8 d27 Z10 T19	80	8	27	12	10	19			
BSDF CC06 D100x8 d32 Z12 T22.5	100	8	32	12	12	22.5			
BSDF CC06 D125x8 d40 Z14 T32.5	125	8	40	12	14	32.5			
BSDF CC06 D60x10 d22 Z08 T14	60	10	22	14	8	14			
BSDF CC06 D80x10 d27 Z10 T19	80	10	27	14	10	19			
BSDF CC06 D100x10 d32 Z12 T22.5	100	10	32	14	12	22.5			
BSDF CC06 D125x10 d40 Z14 T32.5	125	10	40	14	14	32.5			
BSDF CC06 D160x10 d40 Z16 T47.5	160	10	40	14	16	47.5			
<b>BSDF CC06 D200x10 d40 Z18 T70</b>	200	10	40	14	18	70			
BSDF CC09 D80x12 d27 Z08 T17.5	80	12	27	16	8	17.5	CC..09T3.. ISO	SSV M3.5x10 9511	T15
BSDF CC09 D100x12 d32 Z10 T22.5	100	12	32	16	10	22.5			
BSDF CC09 D125x12 d40 Z12 T29	125	12	40	16	12	29			
BSDF CC09 D160x12 d40 Z14 T45	160	12	40	16	14	45			
<b>BSDF CC09 D200x12 d40 Z16 T70</b>	200	12	40	16	16	70			
BSDF CC09 D80x14 d27 Z08 T17.5	80	14	27	18	8	17.5			
BSDF CC09 D100x14 d32 Z10 T22.5	100	14	32	18	10	22.5			
BSDF CC09 D125x14 d40 Z12 T29	125	14	40	18	12	29			
BSDF CC09 D160x14 d40 Z14 T45	160	14	40	18	14	45			
BSDF CC09 D200x14 d40 Z16 T70	200	14	40	18	16	70			
<b>BSDF CC12 D200x16 d40 Z12 T70</b>	200	16	40	20	12	70	CC..1204.. ISO	SSV M4x12-9515	
<b>BSDF CC12 D200x18 d40 Z12 T70</b>	200	18	40	20	12	70			

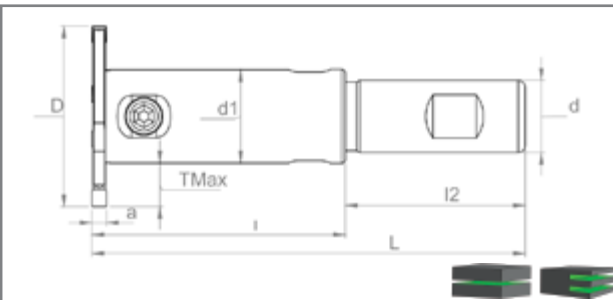

KOD CODE	ÖLÇÜLER DIMENSION (mm)									KESİCİ UÇ INSERT	YEDEK PARÇALAR SPARE PARTS	
	D	d	d1	l	l2	L	a	Z	T <sub>max</sub>		Sıkma Vidası Clamp Screw	Alyan Anahtar Allen Key
<b>DKT KANAL TAKIMLARI</b>												
DKT K3C D50 W20 L120 Z2 T12	50	20	26	70	50	120	3	2	12	MGM 3C KRLY UCA UYGUNDUR FOR KRLY INSERT	BKTV-M6x25-9215	AA5
DKT K3C D63 W25 L120 Z2 T17	63	25	29	65	55	120	3	2	17		BKTV-M8x30-9216	AA6
DKT K3C D80 W32 L120 Z2 T20.5	80	32	39	60	60	120	3	2	20.5			
DKT K4C D50 W20 L120 Z2 T12	50	20	26	70	50	120	4	2	12	MGM 4C KRLY UCA UYGUNDUR FOR KRLY INSERT	BKTV-M6x25-9215	AA5
DKT K4C D63 W25 L120 Z2 T17	63	25	29	65	55	120	4	2	17		BKTV-M8x30-9216	AA6
DKT K4C D80 W32 L120 Z2 T20.5	80	32	39	60	60	120	4	2	20.5			
DKT K5C D50 W20 L120 Z2 T12	50	20	26	70	50	120	5	2	12	MGM 5C KRLY UCA UYGUNDUR FOR KRLY INSERT	BKTV-M6x25-9215	AA5
DKT K5C D63 W25 L120 Z2 T17	63	25	29	65	55	120	5	2	17		BKTV-M8x30-9216	AA6
DKT K5C D80 W32 L120 Z2 T20.5	80	32	39	60	60	120	5	2	20.5			

## HAVŞA FREZELER Chamfering End Mills

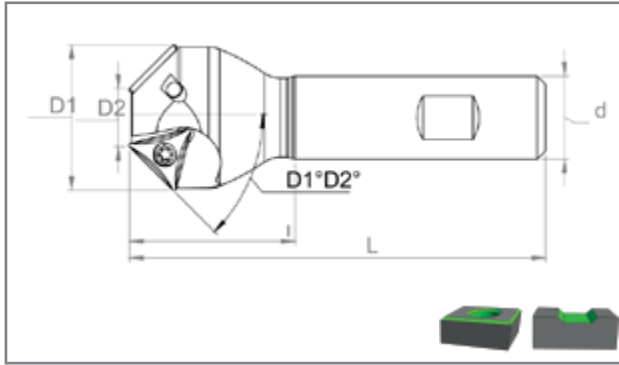



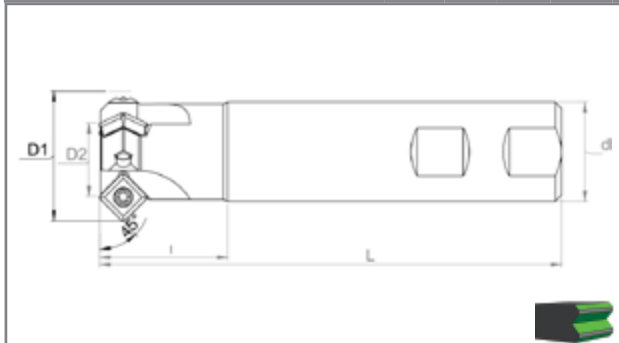

KOD CODE	ÖLÇÜLER DIMENSION (mm)							KESİCİ UÇ INSERT	YEDEK PARÇALAR SPARE PARTS	
	D1° D2°	D2	D1	L	d	Z	I		Sıkma Vidası Clamp Screw	Anahtar Torx Key
<b>10°/15°/17.5°/20°/22.5°/25°/30°/45° HAVŞA FREZELER CHAMFERING TOOLS-ISO</b>										
HF10° TC16 D18~21 W16 L100 Z01	10°	18	21	100	16	1	30	TCM..16T3.. ISO	SSV M3.5x10 9511	T15
HF15° TC16 D17~22 W16 L100 Z01	15°	17	22	100	16	1	30			
HF17.5° TC16 D17~24 W16 L100 Z01	17.5°	17	24	100	16	1	30			
HF20° TC16 D12~20 W16 L100 Z01	20°	12	20	100	16	1	30			
HF20° TC16 D17~26 W20 L100 Z01	20°	17	26	100	20	1	30			
HF22.5° TC16 D17~28 W20 L100 Z01	22.5°	17	28	100	20	1	30			
HF25° TC16 D17~30 W16 L100 Z01	25°	17	30	100	16	1	30			
HF30° TC16 D6~20 W16 L100 Z01	30°	6	20	100	16	1	30			
HF30° TC16 D20~35 W16 L100 Z02	30°	20	35	100	16	2	40			
HF30° TC16 D30~45 W32 L100 Z03	30°	30	45	100	32	3	40			
HF45° TC11 D4~15 W16 L100 Z01-H	45°	4	15	100	16	1	30	TCM..1102.. ISO	SSV M2.5x7 9506	T08
HF45° TC11 D4~15 W16 L100 Z01	45°	4	15	100	16	1	30			
HF45° TC16 D5~26 W16 L100 Z01	45°	5	26	100	16	1	30	TCM..16T3.. ISO	SSV M3.5x10 9511	T15
HF45° TC16 D10~31 W20 L100 Z02-H	45°	10	31	100	20	2	35			
HF45° TC16 D10~31 W20 L100 Z02	45°	10	31	100	20	2	35			
HF45° TC16 D14~35 W20 L100 Z02-H	45°	14	35	100	20	2	40			
HF45° TC16 D14~35 W20 L100 Z02	45°	14	35	100	20	2	40			
HF45° TC16 D22~43 W25 L100 Z03-H	45°	22	43	100	25	3	40			
HF45° TC16 D22~43 W25 L100 Z03	45°	22	43	100	25	3	40			
HF45° TC16 D32~53 W32 L100 Z04	45°	32	53	100	32	4	45			
HF55° TC16 D16~40 W20 L100 Z03	55°	16	40	100	20	3	40	NEW		
HF62° TC16 D14~40 W20 L100 Z03	62°	14	40	100	20	3	40			
HF72° TC16 D14~42 W20 L100 Z03	72°	14	42	100	20	3	40			

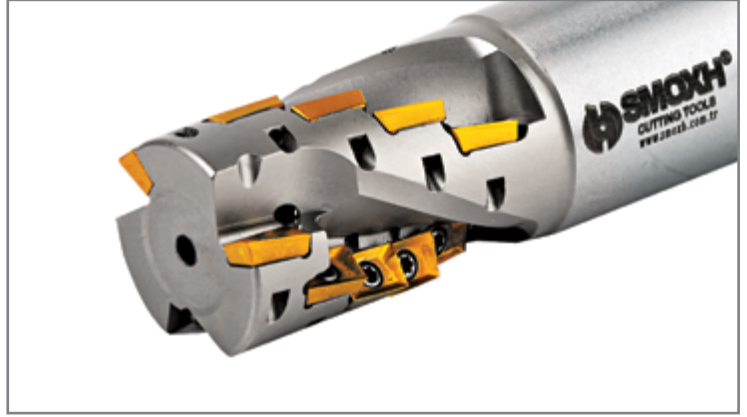
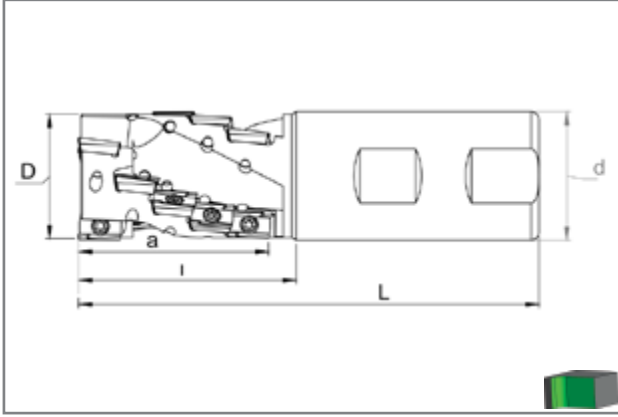

KOD CODE	ÖLÇÜLER DIMENSION (mm)							KESİCİ UÇ INSERT	YEDEK PARÇALAR SPARE PARTS	
	D1° D2°	D2	D1	L	d	Z	I		Sıkma Vidası Clamp Screw	Anahtar Torx Key
<b>HF45° HAVŞA FREZELER CHAMFERING TOOLS</b>										
HF45° SP09 D11~25 W20 L150 Z01	45°	11	25	150	20	1	30	SPMG 0904.. TGTC UCA UYGUNDUR FOR TGTC INSERT	SSV M3.5x10 9511	T15
HF45° SP11 D24~38 W25 L150 Z02	45°	24	38	150	25	2	35	SPMG 1104.. TGTC UCA UYGUNDUR FOR TGTC INSERT		
HF45° SP11 D31~45 W32 L150 Z03	45°	31	45	150	32	3	40			SSV M4x10-9514

## HELİSEL FREZELER Helical Cutter





KOD CODE	ÖLÇÜLER DIMENSION (mm)							KESİCİ UÇ INSERT	YEDEK PARÇALAR SPARE PARTS	
	D	Z	Z <sub>1</sub>	d	L	l	a		Sıkma Vidası Clamp Screw	Anahtar Torx Key
<b>HT90 HELİSEL FREZELER HELICAL CUTTER-ISO</b>										
HT90 AP10 D20 L87 A20 Z06-H	20	2	6	20	87	40	28	AP.. 1003.. ISO UCA UYGUNDUR FOR ISO INSERT	SSV M2.5x7 9506	T08
HT90 AP10 D25 L105 A25 Z08-H	25	2	8	25	105	45	38			
HT90 AP10 D32 L115 A32 Z15-H	32	3	15	32	115	55	47			
HT90 AP10 D40 L130 A32 Z18-H	40	3	18	32	130	75	55			

\*Z<sub>1</sub>=Etkili kesici ağzı \*Z<sub>1</sub>= Effective Cutting Teeth

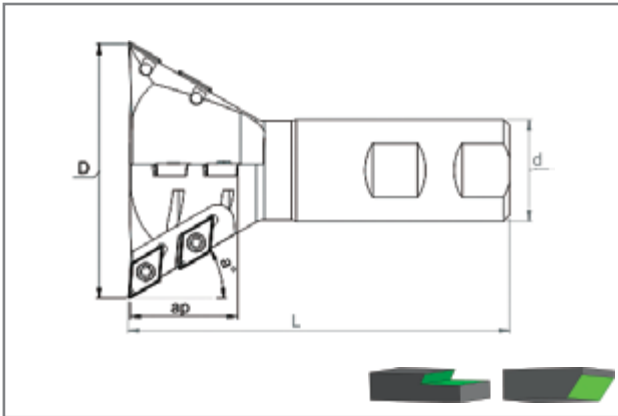
## KIRLANGIÇ FREZELER Dove Mills



KOD CODE	ÖLÇÜLER DIMENSION (mm)							KESİCİ UÇ INSERT	YEDEK PARÇALAR SPARE PARTS	
	D	Z	Z <sub>1</sub>	d	L	a°	ap		Sıkma Vidası Clamp Screw	Anahtar Torx Key
<b>BKRF 55° / 60° KIRLANGIÇ FREZELER DOVE MILLS-ISO</b>										
BKRF60 DC11 D32 W20 L120 Z02	32	2	2	20	120	60	10	DCM.11T304 ISO UCA UYGUNDUR FOR ISO INSERT	SSV M3.5x10 9511	T15
BKRF60 DC11 D40 W25 L120 Z02	40	2	2	25	120	60	10			
BKRF60 DC11 D50 W40 L120 Z04	50	4	4	25	120	60	18			
BKRF55 DC11 D60 W25 L120 Z04	60	4	6	25	120	55	24			
BKRF60 DC11 D80 W32 L120 Z04	80	4	8	32	120	60	34			

\*Z<sub>1</sub>=Etkili kesici ağzı \*Z<sub>1</sub>= Effective Cutting Teeth

## AYARLI KABA DELİK İŞLEME BARALARI

### Adjustable Rough Boring Heads

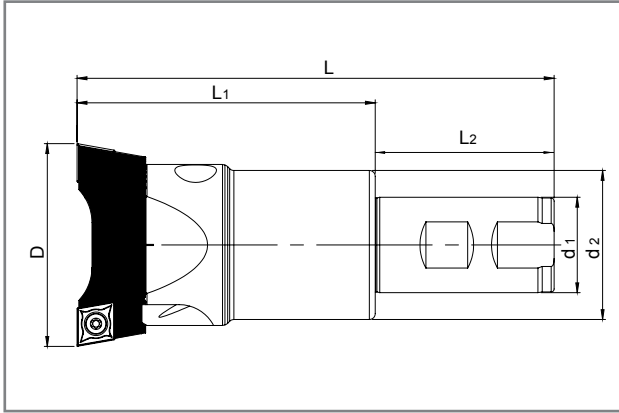

KOD CODE	ÖLÇÜLER DIMENSION (mm)							YEDEK PARÇALAR SPARE PARTS						
	D min	D max	d1	d2	L	L1	L2	Kartuş Cartridge	Elmas Insert	Elmas Vidası Insert Screw	Kartuş Vidası Cartridge Screw	Ayar Vidası Adjustment Screw	Anahtar Key	
<b>SBT BARA TAKIMI ADJUSTABLE BORING BAR-ISO</b>														
SBT CC06 D20-24 W16 L100	20	24	16	16	100	50	50	KR 20-24	CC..0602.. ISO	SSV M2.5x6 9505	BKTV M4x14 9210	SNSV M3x6 9301	T08	
SBT CC06 D20-24 W16 L150	20	24	16	16	150	100	50				BKTV M5x20x8 9212	SNSV M4x8 9302		
SBT CC06 D24-29 W20 L100	24	29	20	22	100	50	50				KR 24-29	CC..09T3.. ISO		SSV M3.5x8 9510
SBT CC06 D24-29 W20 L150	24	29	20	22	150	100	50	KR 39-49	SSV M3.5x10 9511	SNSV M4x12 9304				
SBT CC06 D24-29 W20 L230	24	29	20	22	230	180	50			KR 49-60			SNSV M4x14 9305	
SBT CC09 D29-39 W20 L105	29	39	20	25	105	55	50	KR 29-39	CC..1204.. ISO		SSV M5x13 9519	BKTV M8x30x11 9217	SNSV M5x15 9307	T20
SBT CC09 D29-39 W20 L155	29	39	20	25	155	105	50			KR 59-79				
SBT CC09 D29-39 W20 L230	29	39	20	25	230	175	55	KR 69-89	CC..1204.. ISO		SSV M5x13 9519	BKTV M8x30x11 9217	SNSV M5x15 9307	T20
SBT CC09 D39-49 W25 L120	39	49	25	32	120	65	55			KR 89-130				
SBT CC09 D39-49 W25 L170	39	49	25	32	170	115	55	KR 89-130	CC..1204.. ISO		SSV M5x13 9519	BKTV M8x30x11 9217	SNSV M5x15 9307	T20
SBT CC09 D39-49 W25 L250	39	49	25	32	250	200	55			KR 89-130				
SBT CC09 D49-60 W32 L126	49	60	32	40	126	66	60	KR 89-130	CC..1204.. ISO		SSV M5x13 9519	BKTV M8x30x11 9217	SNSV M5x15 9307	T20
SBT CC09 D49-60 W32 L176	49	60	32	40	176	116	60			KR 89-130				
SBT CC09 D49-60 W32 L260	49	60	32	40	260	200	60	KR 89-130	CC..1204.. ISO		SSV M5x13 9519	BKTV M8x30x11 9217	SNSV M5x15 9307	T20
SBT CC12 D59-79 W32 L145	59	79	32	50	145	85	60			KR 89-130				
SBT CC12 D59-79 W32 L195	59	79	32	50	195	135	60	KR 89-130	CC..1204.. ISO		SSV M5x13 9519	BKTV M8x30x11 9217	SNSV M5x15 9307	T20
SBT CC12 D59-79 W32 L280	59	79	32	50	280	220	60			KR 89-130				
SBT CC12 D69-89 W32 L145	69	89	32	63	145	85	60	KR 89-130	CC..1204.. ISO		SSV M5x13 9519	BKTV M8x30x11 9217	SNSV M5x15 9307	T20
SBT CC12 D69-89 W32 L195	69	89	32	63	195	135	60			KR 89-130				
SBT CC12 D69-89 W32 L290	69	89	32	63	290	220	70	KR 89-130	CC..1204.. ISO		SSV M5x13 9519	BKTV M8x30x11 9217	SNSV M5x15 9307	T20
<b>SBT CC12 D69-89 W40 L290</b>	<b>69</b>	<b>89</b>	<b>40</b>	<b>63</b>	<b>290</b>	<b>220</b>	<b>70</b>			KR 89-130				
SBT CC12 D89-130 W32 L175	89	130	32	75	175	105	60	KR 89-130	CC..1204.. ISO		SSV M5x13 9519	BKTV M8x30x11 9217	SNSV M5x15 9307	T20
SBT CC12 D89-130 W32 L225	89	130	32	75	225	165	60			KR 89-130				

**Teknoloji profesyonellikle birleŖti**  
Technology combined with professionalism

[www.smoxh.com.tr](http://www.smoxh.com.tr)



## **YÜZEY FREZELER**

Face Milling Cutter



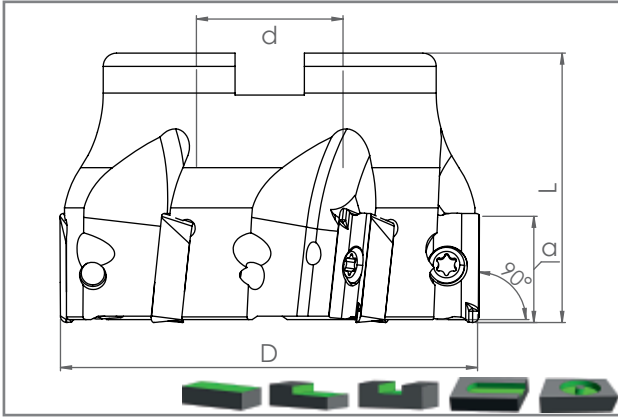

## YÜZEY FREZELER Face Milling Cutter

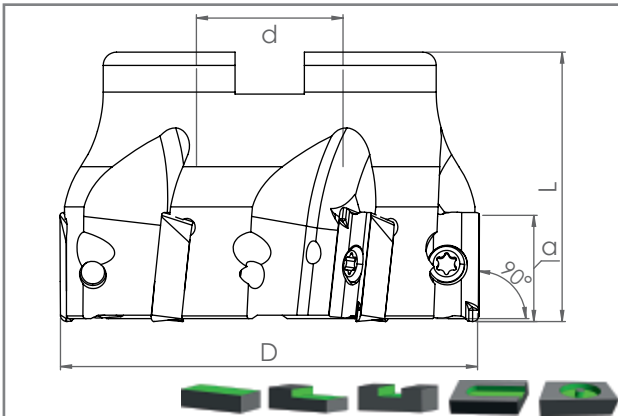

KOD CODE	ÖLÇÜLER DIMENSION (mm)					KESİCİ UÇ INSERT	YEDEK PARÇALAR SPARE PARTS	
	D	Z	d	L	a		Sıkma Vidası Clamp Screw	Anahtar Torx Key
<b>TK90 APKT 1003.. ISO</b>								
TK90 AP10 D40 A16 Z05-H	40	5	16	40	10	AP. 1003.. ISO UCA UYGUNDUR FOR ISO INSERT	SSV M2.5x7 9506	T08
TK90 AP10 D50 A22 Z06-H	50	6	22	40	10			
TK90 AP10 D63 A22 Z07-H	63	7	22	40	10			
TK90 AP10 D80 A27 Z08-H	80	8	27	50	10			
TK90 AP10 D100 A32 Z09-H	100	9	32	50	10			
TK90 AP10 D125 B40 Z11	125	11	40	63	10			





KOD CODE	ÖLÇÜLER DIMENSION (mm)					KESİCİ UÇ INSERT	YEDEK PARÇALAR SPARE PARTS	
	D	Z	d	L	a		Sıkma Vidası Clamp Screw	Anahtar Torx Key
<b>TK90 APKT 1604.. ISO</b>								
TK90 AP16 D40 A16 Z04-H	40	4	16	40	16	AP. 1604.. ISO UCA UYGUNDUR FOR ISO INSERT	SSV M3.5x10 9511	T15
TK90 AP16 D50 A22 Z05-H	50	5	22	40	16			
TK90 AP16 D63 A22 Z06-H	63	6	22	40	16			
TK90 AP16 D80 A27 Z07-H	80	7	27	50	16			
TK90 AP16 D100 A32 Z08-H	100	8	32	50	16			
TK90 AP16 D125 B40 Z09	125	9	40	63	16			
TK90 AP16 D160 C40 Z10	160	10	40	63	16			
TK90 AP16 D200 B60 Z12	200	12	60	63	16			



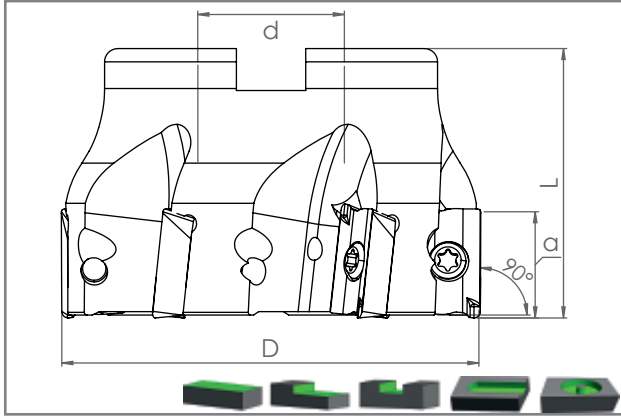

## YÜZEY FREZELER Face Milling Cutter



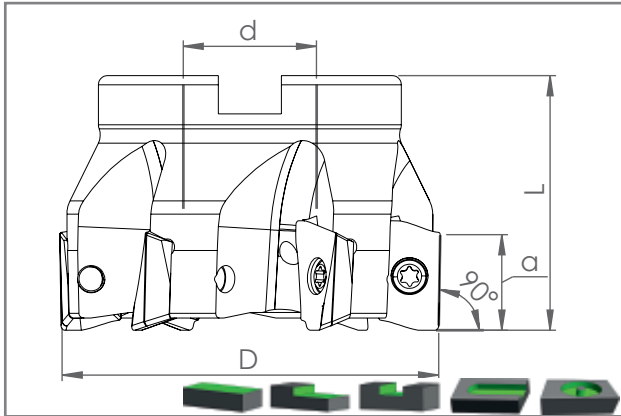



KOD CODE	ÖLÇÜLER DIMENSION (mm)					KESİCİ UÇ INSERT	YEDEK PARÇALAR SPARE PARTS	
	D	Z	d	L	a		Sıkma Vidası Clamp Screw	Anahtar Torx Key
<b>TK90 APMT 1135..</b>								
TK90 APMT11 D40 A16 Z05-H	40	5	16	40	11	<b>APMT 1135.. YG-1 UCA UYGUNDUR FOR YG-1 INSERT</b>	<b>SSV M2.5x7 9506</b>	<b>T08</b>
TK90 APMT11 D50 A22 Z06-H	50	6	22	40	11			
TK90 APMT11 D63 A22 Z07-H	63	7	22	40	11			
TK90 APMT11 D80 A27 Z08-H	80	8	27	50	11			

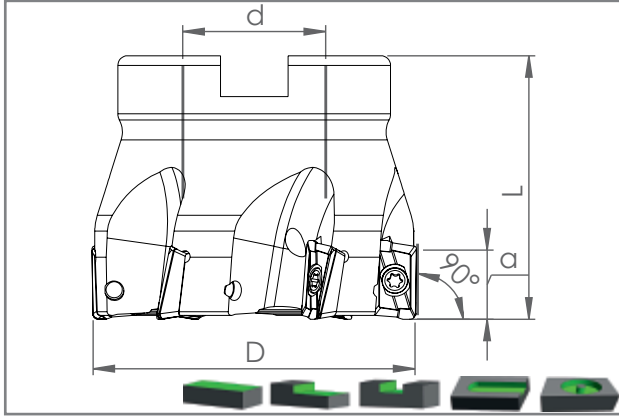

KOD CODE	ÖLÇÜLER DIMENSION (mm)					KESİCİ UÇ INSERT	YEDEK PARÇALAR SPARE PARTS	
	D	Z	d	L	a		Sıkma Vidası Clamp Screw	Anahtar Torx Key
<b>TK90 ADMX 11T3 / 1606..</b>								
TK90 ADMX11 D40 A16 Z05-H	40	5	16	40	10.5	<b>ADMX 11T3.. PRMT UCA UYGUNDUR FOR PRMT INSERT</b>	<b>SSV M2.5x7 9506</b>	<b>T08</b>
TK90 ADMX11 D50 A22 Z06-H	50	6	22	40	10.5			
TK90 ADMX11 D63 A22 Z07-H	63	7	22	40	10.5			
TK90 ADMX16 D50 A22 Z05-H	50	5	22	40	16	<b>ADMX 1606.. PRMT UCA UYGUNDUR FOR PRMT INSERT</b>	<b>SSV M4x10 9514</b>	<b>T15</b>
TK90 ADMX16 D63 A22 Z06-H	63	6	22	40	16			
TK90 ADMX16 D80 A27 Z07-H	80	7	27	50	16			

## YÜZEY FREZELER Face Milling Cutter





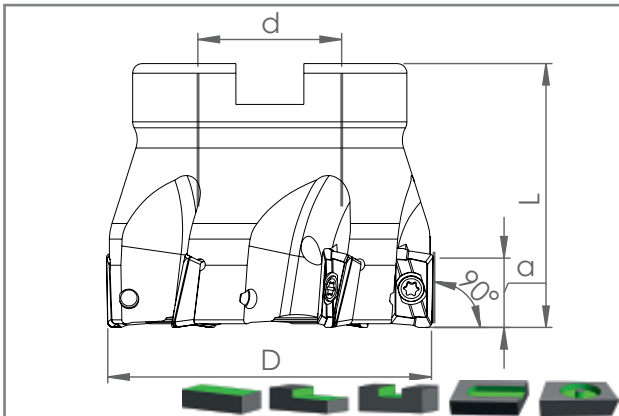

KOD CODE	ÖLÇÜLER DIMENSION (mm)					KESİCİ UÇ INSERT	YEDEK PARÇALAR SPARE PARTS	
	D	Z	d	L	a		Sıkma Vidası Clamp Screw	Anahtar Torx Key
<b>TK90 APKT 11T3..</b>								
TK90 APKT11 D40 A16 Z05-H	40	5	16	40	11	APKT 11T3.. ZCC-CT UCA UYGUNDUR FOR ZCC-CT INSERT	SSV M2.5x7 9506	T08
TK90 APKT11 D50 A22 Z06-H	50	6	22	40	11			
TK90 APKT11 D63 A22 Z07-H	63	7	22	40	11			



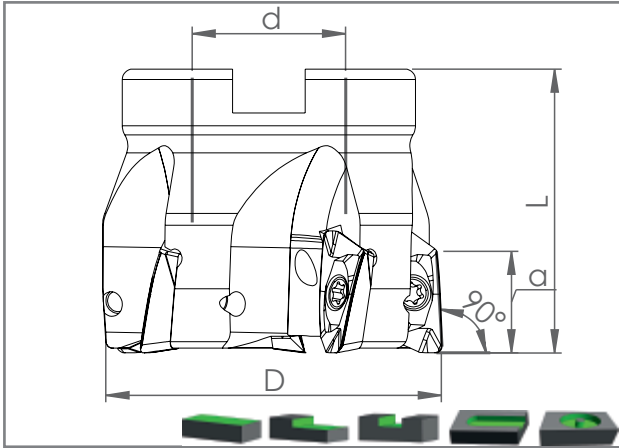

KOD CODE	ÖLÇÜLER DIMENSION (mm)					KESİCİ UÇ INSERT	YEDEK PARÇALAR SPARE PARTS	
	D	Z	d	L	a		Sıkma Vidası Clamp Screw	Anahtar Torx Key
<b>TK90 APMT 11T3..</b>								
TK90 AP11 D40 A16 Z05-H	40	5	16	40	11	APMT 11T3.. KRLY UCA UYGUNDUR FOR KRLY INSERT	SSV M2.5x7 9506	T08
TK90 AP11 D50 A22 Z06-H	50	6	22	40	11			
TK90 AP11 D63 A22 Z07-H	63	7	22	40	11			
TK90 AP11 D80 A27 Z08-H	80	8	27	50	11			

## YÜZEY FREZELER Face Milling Cutter

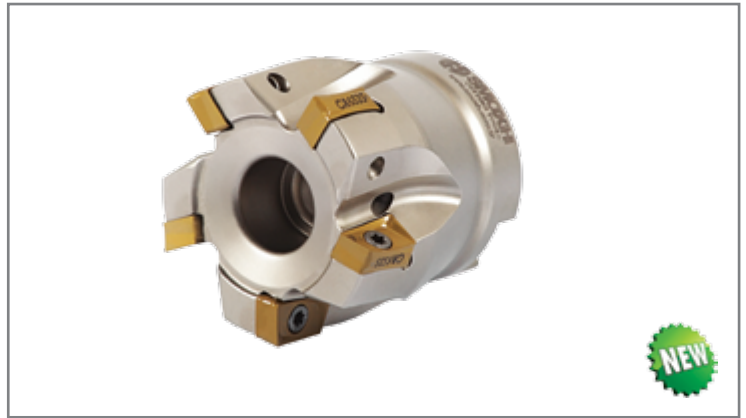
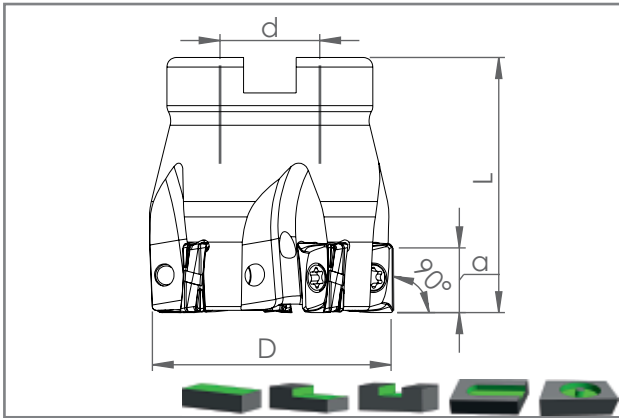

KOD CODE	ÖLÇÜLER DIMENSION (mm)					KESİCİ UÇ INSERT	YEDEK PARÇALAR SPARE PARTS	
	D	Z	d	L	a		Sıkma Vidası Clamp Screw	Anahtar Torx Key
<b>TK90 EDPT 10T3 / 1404..</b>								
TK90 ED10 D40 A16 Z05-H	40	5	16	40	9.87	EDPT 10T3.. KNMTL UCA UYGUNDUR FOR KNMTL INSERT	SSV M2.5x7 9506	T08
TK90 ED10 D50 A22 Z06-H	50	6	22	40	9.87			
TK90 ED10 D63 A22 Z07-H	63	7	22	40	9.87			
TK90 ED14 D40 A16 Z04-H	40	4	16	40	13.8	EDPT 1404.. KNMTL UCA UYGUNDUR FOR KNMTL INSERT	SSV M3x8 9508	T08
TK90 ED14 D50 A22 Z05-H	50	5	22	40	13.8			
TK90 ED14 D63 A22 Z06-H	63	6	22	40	13.8			
TK90 ED14 D80 A27 Z07-H	80	7	27	50	13.8			



KOD CODE	ÖLÇÜLER DIMENSION (mm)					KESİCİ UÇ INSERT	YEDEK PARÇALAR SPARE PARTS	
	D	Z	d	L	a		Sıkma Vidası Clamp Screw	Anahtar Torx Key
<b>TK90 LOMU / LOGT 1004 / 1505..</b>								
TK90 LM10 D40 A16 Z05-H	40	5	16	40	10	LOMU / LOGT 1004.. KYCR UCA UYGUNDUR FOR KYCR INSERT	SSV M3x6 LG 9509	T08
TK90 LM10 D50 A22 Z05-H	50	5	22	40	10			
TK90 LM10 D63 A22 Z06-H	63	6	22	40	10			
TK90 LM15 D40 A16 Z04-H	40	4	16	40	15	LOMU / LOGT 1505.. KYCR UCA UYGUNDUR FOR KYCR INSERT	SSV M4x12-9515	T15
TK90 LM15 D50 A22 Z04-H	50	4	22	40	15			
TK90 LM15 D63 A22 Z05-H	63	5	22	40	15			
TK90 LM15 D80 A27 Z06-H	80	6	27	50	15			

H-İÇTEN SU VERMELİ  
H-WITH COOLANT HOLE

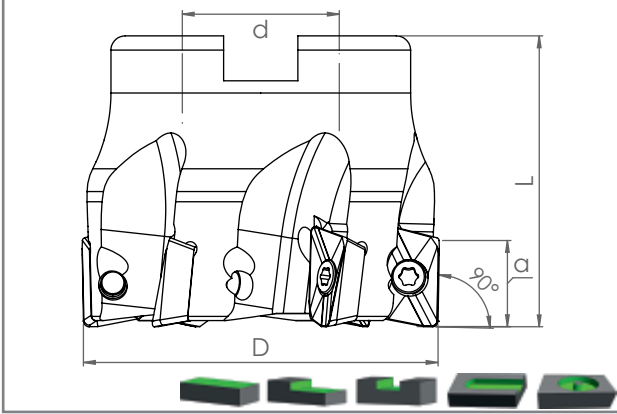

## YÜZEY FREZELER Face Milling Cutter





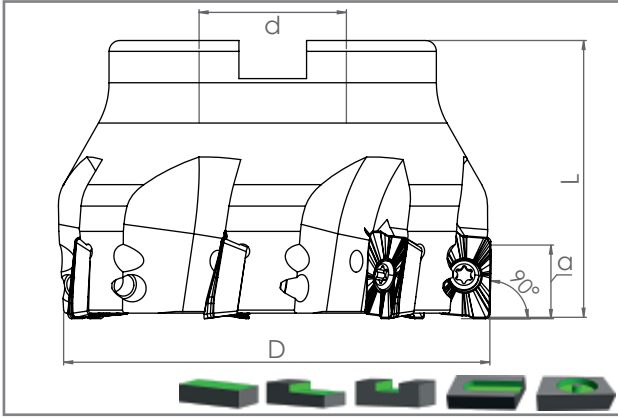

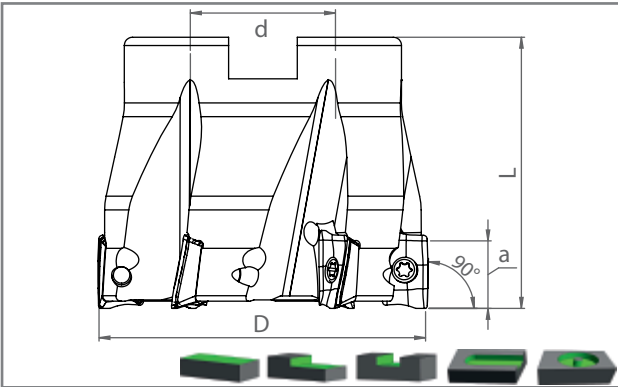

KOD CODE	ÖLÇÜLER DIMENSION (mm)					KESİCİ UÇ INSERT	YEDEK PARÇALAR SPARE PARTS	
	D	Z	d	L	a		Sıkma Vidası Clamp Screw	Anahtar Torx Key
<b>TK90 XOMX 1204 / 1806..</b>								
TK90 XO12 D40 A16 Z05-H	40	5	16	40	11	<b>XOMX 1204.. SECO UCA UYGUNDUR FOR SECO INSERT</b>	<b>SSV M3.5x8 SC-9513</b>	<b>T10</b>
TK90 XO12 D50 A22 Z06-H	50	6	22	40	11			
TK90 XO12 D63 A22 Z08-H	63	8	22	40	11			
TK90 XO12 D80 A27 Z09-H	80	9	27	50	11			
TK90 XO12 D100 A32 Z11-H	100	11	32	50	11			
TK90 XO12 D125 B40 Z12	125	12	40	63	11			
TK90 XO18 D50 A22 Z04-H	50	4	22	40	17	<b>XOMX 1806.. SECO UCA UYGUNDUR FOR SECO INSERT</b>	<b>SSV M4.5x11 9518</b>	<b>T20</b>
TK90 XO18 D63 A22 Z05-H	63	5	22	40	17			
TK90 XO18 D80 A27 Z07-H	80	7	27	50	17			
TK90 XO18 D100 A32 Z09-H	100	9	32	50	17			
TK90 XO18 D125 B40 Z10	125	10	40	63	17			

## YÜZEY FREZELER Face Milling Cutter



KOD CODE	ÖLÇÜLER DIMENSION (mm)					KESİCİ UÇ INSERT	YEDEK PARÇALAR SPARE PARTS	
	D	Z	d	L	a		Sıkma Vidası Clamp Screw	Anahtar Torx Key
<b>TK90 ADKT 1505..</b>								
TK90 AD1505 D40 A16 Z04-H	40	4	16	40	15	<b>ADKT 1505.. ISCR UCA UYGUNDUR FOR ISCR INSERT</b>	<b>SSV M4x10 9514</b>	<b>T15</b>
TK90 AD1505 D50 A22 Z05-H	50	5	22	40	15			
TK90 AD1505 D63 A22 Z06-H	63	6	22	40	15			
TK90 AD1505 D80 A27 Z07-H	80	7	27	50	15			
TK90 AD1505 D100 A32 Z08-H	100	8	32	50	15			
TK90 AD1505 D125 B40 Z09	125	9	40	63	15			



KOD CODE	ÖLÇÜLER DIMENSION (mm)					KESİCİ UÇ INSERT	YEDEK PARÇALAR SPARE PARTS	
	D	Z	d	L	a		Sıkma Vidası Clamp Screw	Anahtar Torx Key
<b>TK90 R390 11T3 / 17T4 / 1806..</b>								
TK90 R390.11 D40 A16 Z05-H	40	5	16	40	10	<b>R390.11T3 SDVK UCA UYGUNDUR FOR SDVK INSERT</b>	<b>SSV M2.5x7 9506</b>	<b>T08</b>
TK90 R390.11 D50 A22 Z06-H	50	6	22	40	10			
TK90 R390.11 D63 A22 Z07-H	63	7	22	40	10			
TK90 R390.17 D40 A16 Z04-H	40	4	16	40	15.7	<b>R390.17T4 SDVK UCA UYGUNDUR FOR SDVK INSERT</b>	<b>SSV M3.5x10 9511</b>	<b>T15</b>
TK90 R390.17 D50 A22 Z05-H	50	5	22	40	15.7			
TK90 R390.17 D63 A22 Z06-H	63	6	22	40	15.7			
TK90 R390.17 D80 A27 Z07-H	80	7	27	50	15.7			
TK90 R390.17 D100 A32 Z08-H	100	8	32	50	15.7			
TK90 R390.17 D125 B40 Z09	125	9	40	63	15.7			
TK90 R390.18 D50 A22 Z05-H 	50	5	22	40	16	<b>R390.1806 SDVK UCA UYGUNDUR FOR SDVK INSERT</b>	<b>SSV M4x12 9515</b>	
TK90 R390.18 D63 A22 Z06-H	63	6	22	40	16			
TK90 R390.18 D80 A27 Z07-H 	80	7	27	50	16			
TK90 R390.18 D100 A32 Z08-H	100	8	32	50	16			

H-İÇTEN SU VERMELİ  
H-WITH COOLANT HOLE

## YÜZEY FREZELER Face Milling Cutter

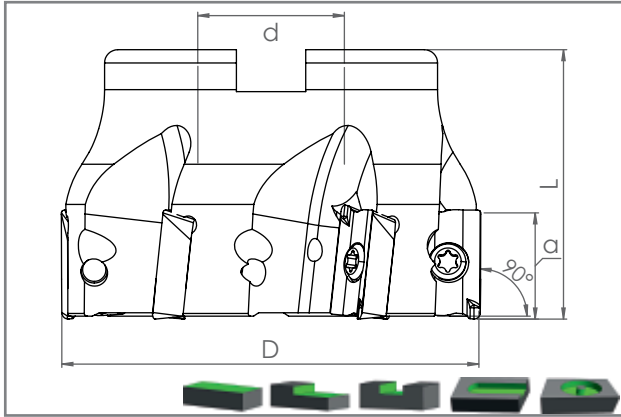



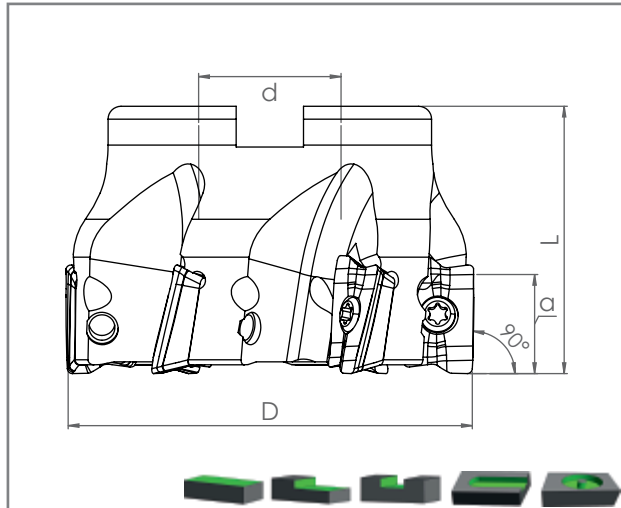

KOD CODE	ÖLÇÜLER DIMENSION (mm)					KESİCİ UÇ INSERT	YEDEK PARÇALAR SPARE PARTS	
	D	Z	d	L	a		Sıkma Vidası Clamp Screw	Anahtar Torx Key
<b>TK90 APKT 1003 / 1604..</b>							Sıkma Vidası Clamp Screw 	Anahtar Torx Key 
TK90 APKT10 D40 A16 Z05-H	40	5	16	40	10	APKT 1003.. KYCR UCA UYGUNDUR FOR KYCR INSERT	SSV M2.5x7 9506	T08
TK90 APKT10 D50 A22 Z06-H	50	6	22	40	10			
TK90 APKT10 D63 A22 Z07-H	63	7	22	40	10			
<b>TK90 APKT16 D40 A16 Z04-H</b>	40	4	16	40	16	APKT 1604.. KYCR UCA UYGUNDUR FOR KYCR INSERT	SSV M3.5x10 9511	T15
TK90 APKT16 D50 A22 Z05-H	50	5	22	40	16			
TK90 APKT16 D63 A22 Z06-H	63	6	22	40	16			
TK90 APKT16 D80 A27 Z07-H	80	7	27	50	16			



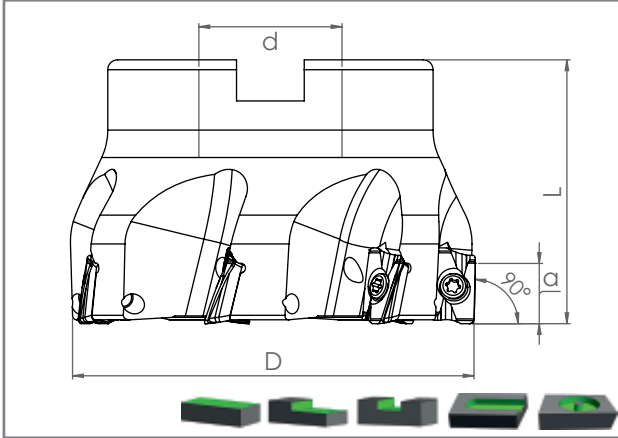



KOD CODE	ÖLÇÜLER DIMENSION (mm)					KESİCİ UÇ INSERT	YEDEK PARÇALAR SPARE PARTS	
	D	Z	d	L	a		Sıkma Vidası Clamp Screw	Anahtar Torx Key
<b>TK90 BDMT 1704..</b>							Sıkma Vidası Clamp Screw 	Anahtar Torx Key 
TK90 BD17 D40 A16 Z04-H	40	4	16	40	15.7	BDMT 1704.. KYCR UCA UYGUNDUR FOR KYCR INSERT	SSV M4x10 9514	T15
TK90 BD17 D50 A22 Z05-H	50	5	22	40	15.7			
TK90 BD17 D63 A22 Z06-H	63	6	22	40	15.7			
TK90 BD17 D80 A27 Z07-H	80	7	27	50	15.7			

## YÜZEY FREZELER Face Milling Cutter

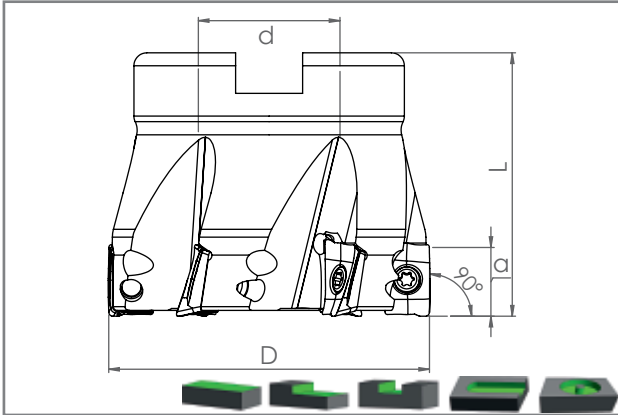

KOD CODE	ÖLÇÜLER DIMENSION (mm)					KESİCİ UÇ INSERT	YEDEK PARÇALAR SPARE PARTS	
	D	Z	d	L	a		Sıkma Vidası Clamp Screw	Anahtar Torx Key
<b>TK90 AOMT 1206..</b>								
TK90 AO12 D40 A16 Z05-H	40	5	16	40	12	<b>AOMT 1206.. MTSBSH UCA UYGUNDUR FOR MTSBSH INSERT</b>	<b>SSV M2.5x7 9506</b>	<b>T08</b>
TK90 AO12 D50 A22 Z06-H	50	6	22	40	12			
TK90 AO12 D63 A22 Z07-H	63	7	22	40	12			
TK90 AO12 D80 A27 Z08-H	80	8	27	50	12			
TK90 AO12 D100 A32 Z10-H	100	10	32	50	12			





KOD CODE	ÖLÇÜLER DIMENSION (mm)					KESİCİ UÇ INSERT	YEDEK PARÇALAR SPARE PARTS	
	D	Z	d	L	a		Sıkma Vidası Clamp Screw	Anahtar Torx Key
<b>TK90 AXMT 1235 / 1705..</b>								
TK90 AX12 D40 A16 Z05-H	40	5	16	40	11	<b>AXMT 1235.. SMTM UCA UYGUNDUR FOR SMTM INSERT</b>	<b>SSV M3x8 9508</b>	<b>T08</b>
TK90 AX12 D50 A22 Z06-H	50	6	22	40	11			
TK90 AX12 D63 A22 Z07-H	63	7	22	40	11			
TK90 AX12 D80 A27 Z09-H	80	9	27	50	11			
TK90 AX17 D40 A16 Z04-H	40	4	16	40	16			
TK90 AX17 D50 A22 Z05-H	50	5	22	40	16	<b>AXMT 1705.. SMTM UCA UYGUNDUR FOR SMTM INSERT</b>	<b>SSV M4x10 9514</b>	<b>T15</b>
TK90 AX17 D63 A22 Z06-H	63	6	22	40	16			
TK90 AX17 D80 A27 Z07-H	80	7	27	50	16			
TK90 AX17 D100 A32 Z08-H	100	8	32	50	16			

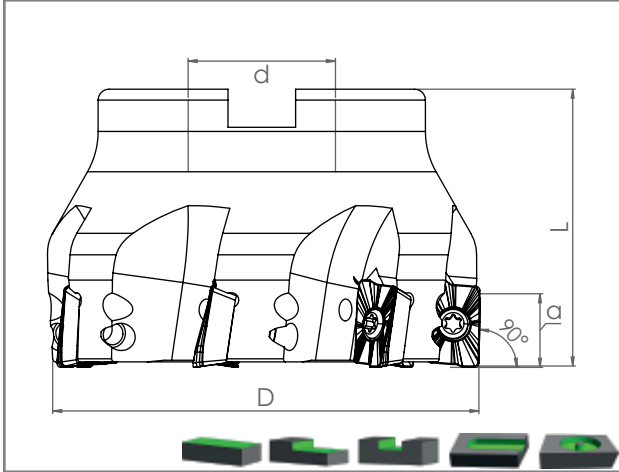

H-İÇTEN SU VERMELİ  
H-WITH COOLANT HOLE

## YÜZEY FREZELER Face Milling Cutter

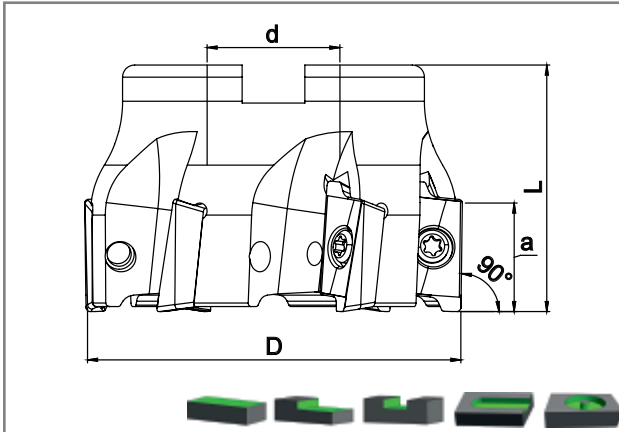

KOD CODE	ÖLÇÜLER DIMENSION (mm)					KESİCİ UÇ INSERT	YEDEK PARÇALAR SPARE PARTS	
	D	Z	d	L	a		Sıkma Vidası Clamp Screw	Anahtar Torx Key
<b>TK90 ADMT 10T3 / 1606..</b>								
TK90 AD10T3 D40 A16 Z05-H	40	5	16	40	10	<b>ADMT 10T3.. WLTR UCA UYGUNDUR FOR WLTR INSERT</b>	SSV M2.5x7 <b>9506</b>	T08
TK90 AD10T3 D50 A22 Z06-H	50	6	22	40	10			
TK90 AD10T3 D63 A22 Z07-H	63	7	22	40	10			
TK90 AD1606 D50 A22 Z05-H	50	5	22	40	15	<b>ADMT 1606.. WLTR UCA UYGUNDUR FOR WLTR INSERT</b>	SSV M3.5x10 <b>9511</b>	T15
TK90 AD1606 D63 A22 Z06-H	63	6	22	40	15			
TK90 AD1606 D80 A27 Z07-H	80	7	27	50	15			







KOD CODE	ÖLÇÜLER DIMENSION (mm)					KESİCİ UÇ INSERT	YEDEK PARÇALAR SPARE PARTS	
	D	Z	d	L	a		Sıkma Vidası Clamp Screw	Anahtar Torx Key
<b>TK90 RT 1003 / 1606..</b>								
TK90 RT10 D40 A16 Z06-H	40	6	16	40	10	<b>RT 1003 SAFETY UCA UYGUNDUR FOR SAFETY INSERT</b>	SSV M2.5x7 <b>9506</b>	T08
TK90 RT10 D50 A22 Z07-H	50	7	22	40	10			
TK90 RT10 D63 A22 Z09-H	63	9	22	40	10			
TK90 RT16 D50 A22 Z05-H	50	5	22	40	16	<b>RT 1606 SAFETY UCA UYGUNDUR FOR SAFETY INSERT</b>	SSV M4x10 <b>9514</b>	T15
TK90 RT16 D63 A22 Z06-H	63	6	22	40	16			
TK90 RT16 D80 A27 Z07-H	80	7	27	50	16			
TK90 RT16 D100 A32 Z08-H	100	8	32	50	16			

H-İÇTEN SU VERMELİ  
H-WITH COOLANT HOLE

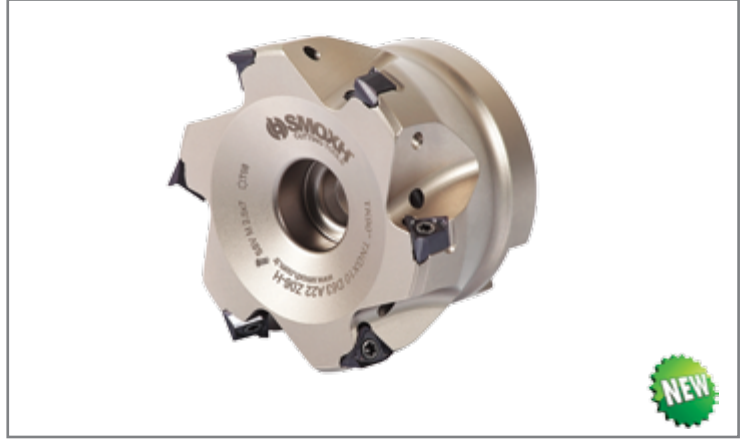
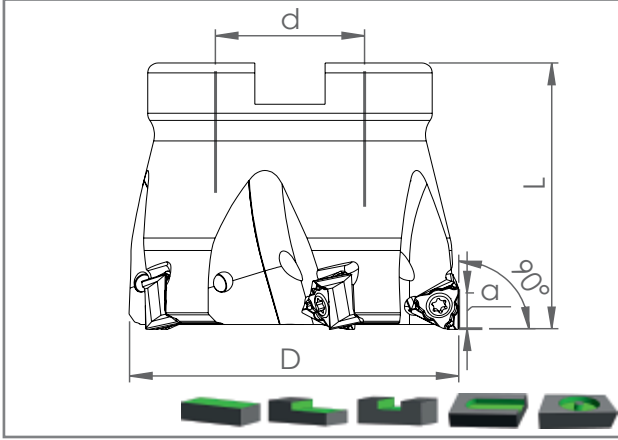



## YÜZEY FREZELER Face Milling Cutter



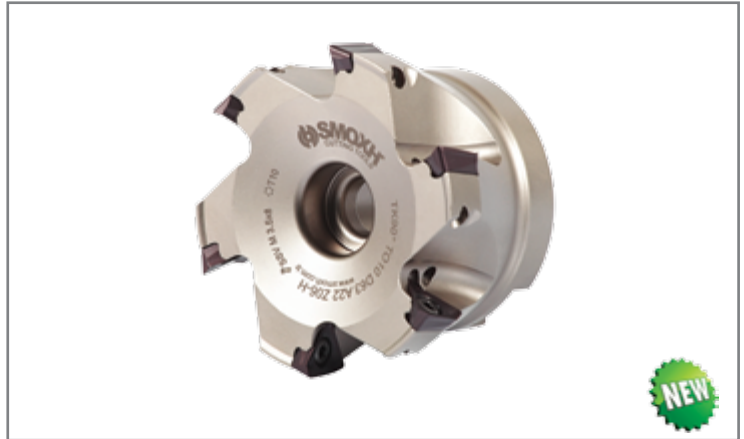
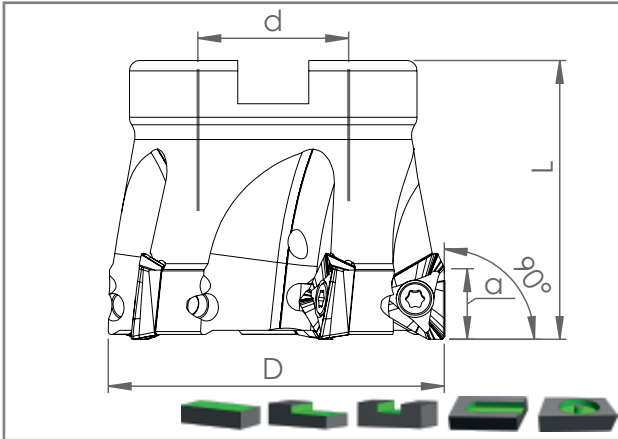



KOD CODE	ÖLÇÜLER DIMENSION (mm)					KESİCİ UÇ INSERT	YEDEK PARÇALAR SPARE PARTS	
	D	Z	d	L	a		Sıkma Vidası Clamp Screw	Anahtar Torx Key
<b>TK90 TNGX 1004..</b>								
TK90 TNGX10 D40 A16 Z04-H	40	4	16	40	5	TK90 TNGX1004.. PRMT UCA UYGUNDUR FOR PRMT INSERT	SSV M2.5x7 9506	T08
TK90 TNGX10 D50 A22 Z05-H	50	5	22	40	5			
TK90 TNGX10 D63 A22 Z06-H	63	6	22	40	5			



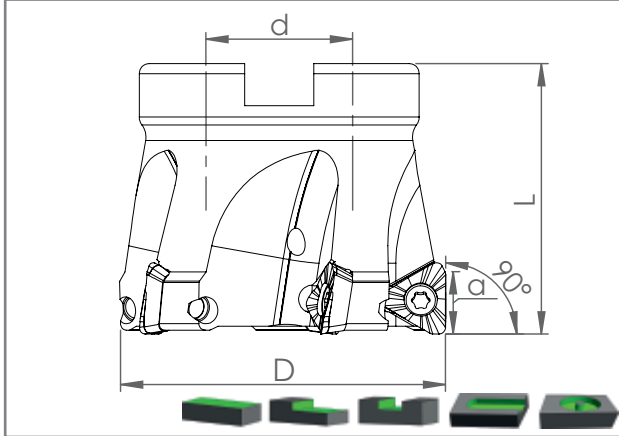



KOD CODE	ÖLÇÜLER DIMENSION (mm)					KESİCİ UÇ INSERT	YEDEK PARÇALAR SPARE PARTS	
	D	Z	d	L	a		Sıkma Vidası Clamp Screw	Anahtar Torx Key
<b>TK90 TOMT 1004..</b>								
TK90 TO10 D40 A16 Z04-H	40	16	4	40	10	TK90 TOMT1004.. TNGLY UCA UYGUNDUR FOR TNGLY INSERT	SSV M3.5x8 SC 9513	T10
TK90 TO10 D50 A22 Z05-H	50	22	5	40	10			
TK90 TO10 D63 A22 Z06-H	63	22	6	40	10			

## YÜZEY FREZELER Face Milling Cutter

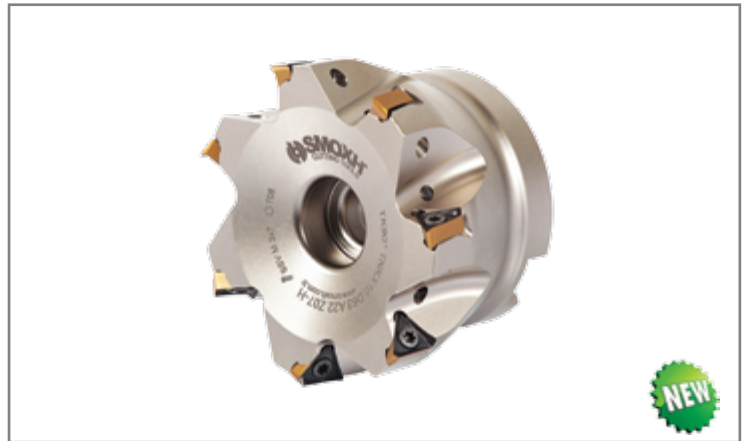
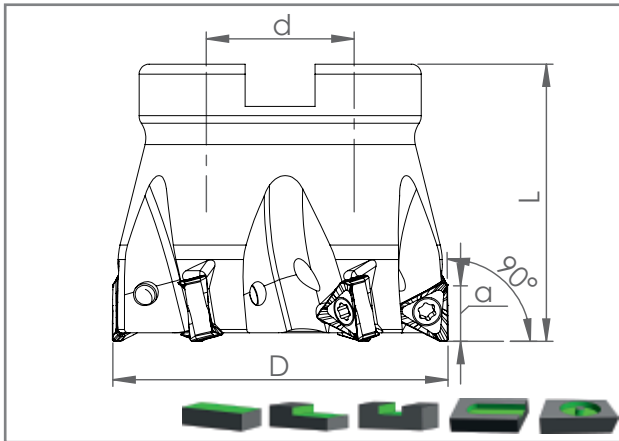





KOD CODE	ÖLÇÜLER DIMENSION (mm)					KESİCİ UÇ INSERT	YEDEK PARÇALAR SPARE PARTS	
	D	Z	d	L	a		Sıkma Vidası Clamp Screw	Anahtar Torx Key
<b>TK90 TP.. 1003..</b>								
TK90 TP10 D40 A16 Z04-H	40	4	16	40	8	<b>TP..1003.. ISCR UCA UYGUNDUR FOR ISCR INSERT</b>	<b>SSV M3.5x8 SC 9513</b>	<b>T15</b>
TK90 TP10 D50 A22 Z05-H	50	5	22	40	8			
TK90 TP10 D63 A22 Z06-H	63	6	22	40	8			
TK90 TP10 D80 A27 Z07-H	80	7	27	50	8			



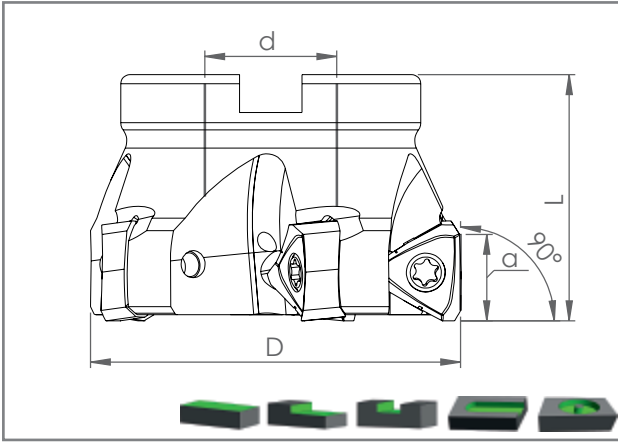



KOD CODE	ÖLÇÜLER DIMENSION (mm)					KESİCİ UÇ INSERT	YEDEK PARÇALAR SPARE PARTS	
	D	Z	d	L	a		Sıkma Vidası Clamp Screw	Anahtar Torx Key
<b>TK90 TN.. 1005..</b>								
TK90 TN1005 D40 A16 Z05-H	40	5	16	40	8	<b>TN.X 1005.. ISCR UCA UYGUNDUR FOR ISCR INSERT</b>	<b>SSV M3x6 LG 9509</b>	<b>T08</b>
TK90 TN1005 D50 A22 Z06-H	50	6	22	40	8			
TK90 TN1005 D63 A22 Z07-H	63	7	22	40	8			

## YÜZEY FREZELER Face Milling Cutter

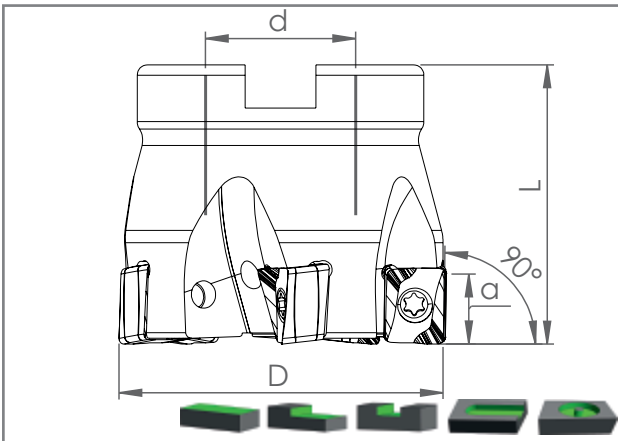

KOD CODE	ÖLÇÜLER DIMENSION (mm)					KESİCİ UÇ INSERT	YEDEK PARÇALAR SPARE PARTS	
	D	Z	d	L	a		Sıkma Vidası Clamp Screw	Anahtar Torx Key
<b>TK90 TNMX 1806..</b>								
TK90 TN18 D63 A22 Z05-H	63	5	22	40	13	TK90 TNMX 1806.. TGTC UCA UYGUNDUR FOR TGTC INSERT	SSV M4x12 9515	T15
TK90 TN18 D80 A27 Z06-H	80	6	27	50	13			
TK90 TN18 D100 A32 Z07-H	100	7	32	50	13			





KOD CODE	ÖLÇÜLER DIMENSION (mm)					KESİCİ UÇ INSERT	YEDEK PARÇALAR SPARE PARTS	
	D	Z	d	L	a		Sıkma Vidası Clamp Screw	Anahtar Torx Key
<b>TK90 LQMU 1107..</b>								
TK90 LQ11 D40 A16 Z04-H	40	16	4	40	9	TK90 LQMU 1107.. TNGLY UCA UYGUNDUR FOR TNGLY INSERT	SSV M3.5x8 SC 9513	T10
TK90 LQ11 D50 A22 Z05-H	50	22	5	40	9			
TK90 LQ11 D63 A22 Z06-H	63	22	6	40	9			

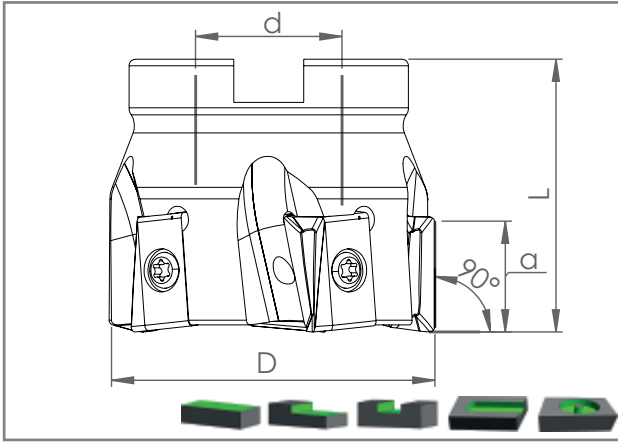

H-İÇTEN SU VERMELİ  
H-WITH COOLANT HOLE

## YÜZEY FREZELER Face Milling Cutter



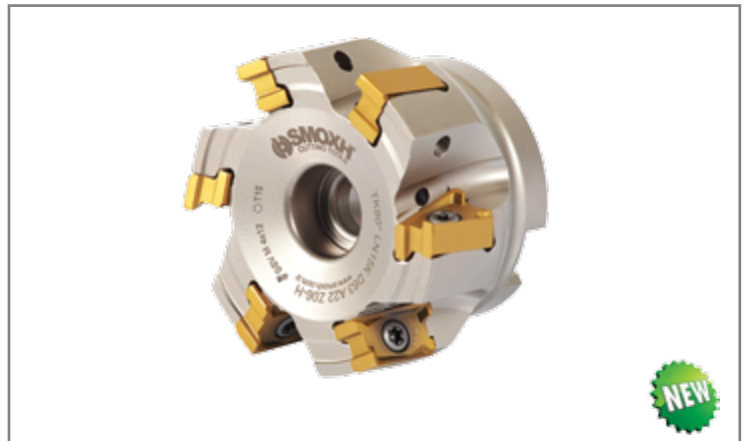
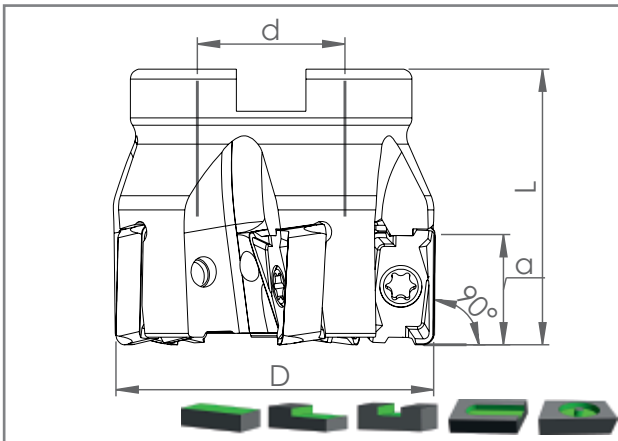



KOD CODE	ÖLÇÜLER DIMENSION (mm)					KESİCİ UÇ INSERT	YEDEK PARÇALAR SPARE PARTS	
	D	Z	d	L	a		Sıkma Vidası Clamp Screw	Anahtar Torx Key
<b>TK90 LNKT 1707..</b>								
TK90 LN17 D50 A22 Z05-H	50	5	22	40	16.5	<b>LNKT 1707.. KRLY UCA UYGUNDUR FOR KRLY INSERT</b>	<b>SSV M4x12 9515</b>	<b>T15</b>
TK90 LN17 D63 A22 Z06-H	63	6	22	40	16.5			
TK90 LN17 D80 A27 Z07-H	80	7	27	50	16.5			
TK90 LN17 D100 A32 Z09-H	100	9	32	50	16.5			



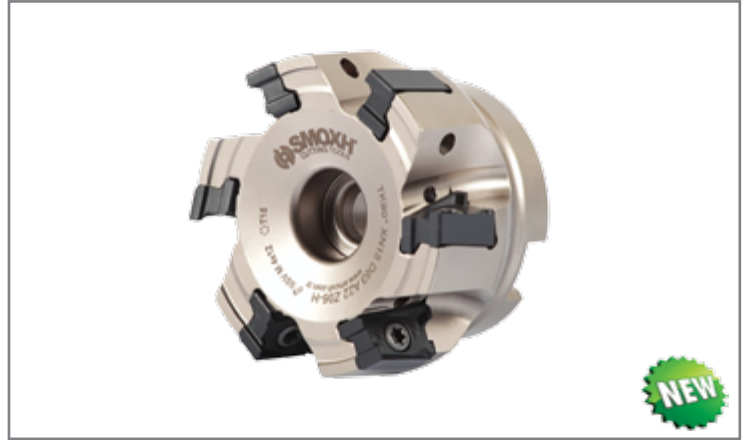
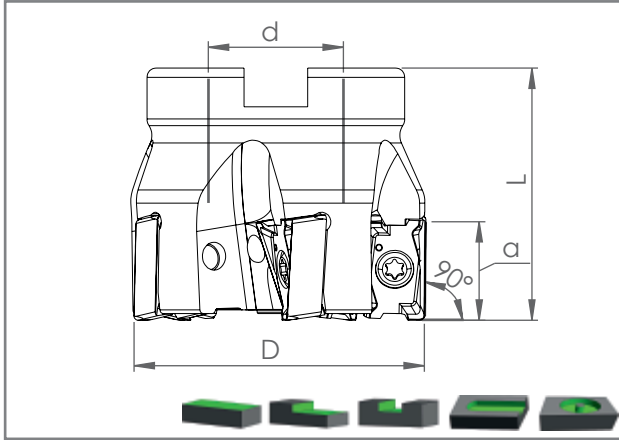



KOD CODE	ÖLÇÜLER DIMENSION (mm)					KESİCİ UÇ INSERT	YEDEK PARÇALAR SPARE PARTS	
	D	Z	d	L	a		Sıkma Vidası Clamp Screw	Anahtar Torx Key
<b>TK90 LNGU 15T6..</b>								
TK90 LNGU15 D40 A16 Z04-H	40	4	16	40	15.5	<b>LNGU 15T6.. KNMTL UCA UYGUNDUR FOR KNMTL INSERT</b>	<b>SSV M4x12 9515</b>	<b>T15</b>
TK90 LNGU15 D50 A22 Z05-H	50	5	22	40	15.5			
TK90 LNGU15 D63 A22 Z06-H	63	6	22	40	15.5			
TK90 LNGU15 D80 A27 Z07-H	80	7	27	50	15.5			
TK90 LNGU15 D100 A32 Z08-H	100	8	32	50	15.5			

## YÜZEY FREZELER Face Milling Cutter

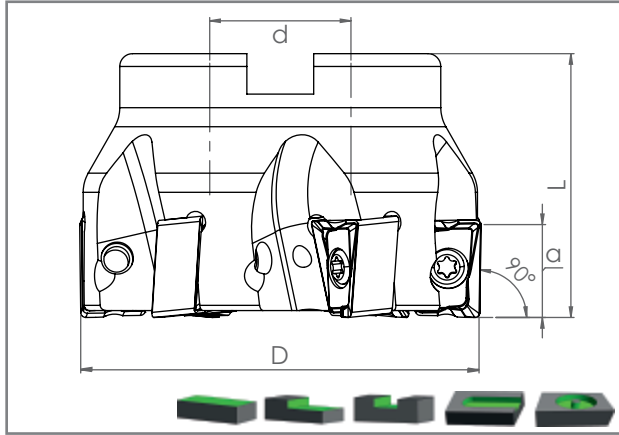

KOD CODE	ÖLÇÜLER DIMENSION (mm)					KESİCİ UÇ INSERT	YEDEK PARÇALAR SPARE PARTS	
	D	Z	d	L	a		Sıkma Vidası Clamp Screw	Anahtar Torx Key
<b>TK90 XNPU 15T6..</b>								
TK90 XN15 D40 A16 Z04-H	40	4	16	40	14.5	<b>XNPU 15T6.. WIDIA UCA UYGUNDUR FOR WIDIA INSERT</b>	<b>SSV M4x12 9515</b>	<b>T15</b>
TK90 XN15 D50 A22 Z05-H	50	5	22	40	14.5			
TK90 XN15 D63 A22 Z06-H	63	6	22	40	14.5			
TK90 XN15 D80 A27 Z07-H	80	7	27	50	14.5			
TK90 XN15 D100 A32 Z08-H	100	8	32	50	14.5			







KOD CODE	ÖLÇÜLER DIMENSION (mm)					KESİCİ UÇ INSERT	YEDEK PARÇALAR SPARE PARTS	
	D	Z	d	L	a		Sıkma Vidası Clamp Screw	Anahtar Torx Key
<b>TK90 LN.X 1006 / 1510..</b>								
TK90 LN10 D40 A16 Z05-H	40	5	16	40	9	<b>LN.X 1006.. KRLY UCA UYGUNDUR FOR KRLY INSERT</b>	<b>SSV M3x8 9508</b>	<b>T08</b>
TK90 LN10 D50 A22 Z06-H	50	6	22	40	9			
TK90 LN10 D63 A22 Z07-H	63	7	22	40	9			
TK90 LN15 D50 A22 Z05-H	50	5	22	40	14	<b>LN.X 1510.. KRLY UCA UYGUNDUR FOR KRLY INSERT</b>	<b>SSV M4x14 9516</b>	<b>T15</b>
TK90 LN15 D63 A22 Z06-H	63	6	22	40	14			
TK90 LN15 D80 A27 Z07-H	80	7	27	50	14			
TK90 LN15 D100 A32 Z09-H	100	9	32	50	14			
TK90 LN15 D125 C40 Z10	125	10	40	63	14			
TK90 LN15 D160 B40 Z12	160	12	40	63	14			

H-İÇTEN SU VERMELİ  
H-WITH COOLANT HOLE

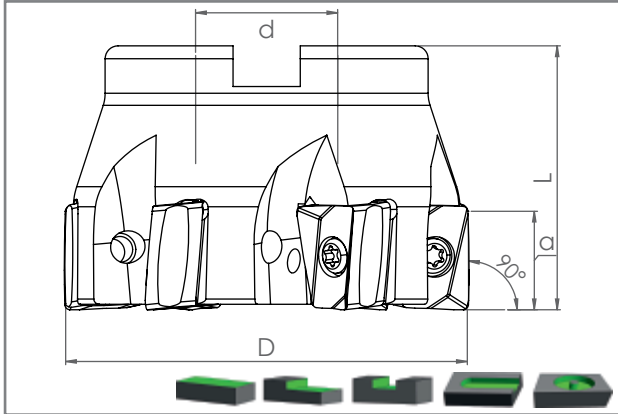

## YÜZEY FREZELER

### Face Milling Cutter

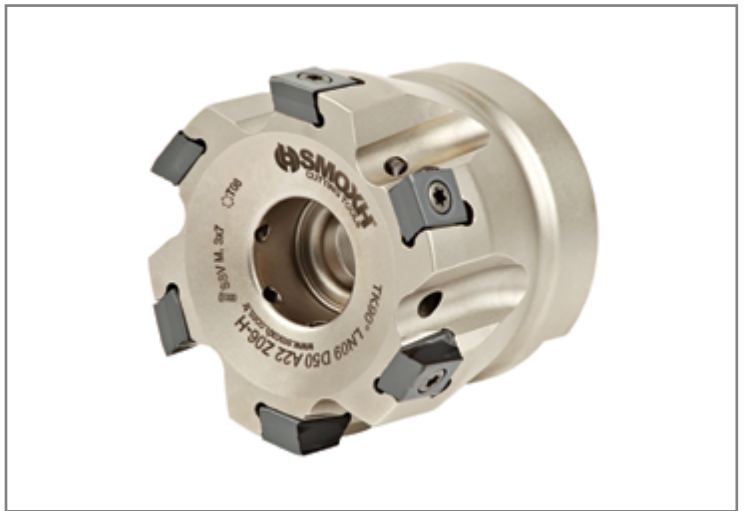
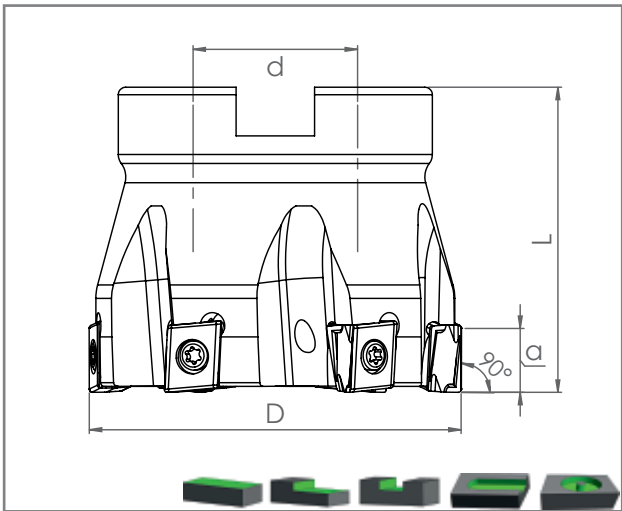

KOD CODE	ÖLÇÜLER DIMENSION (mm)					KESİCİ UÇ INSERT	YEDEK PARÇALAR SPARE PARTS	
	D	Z	d	L	a		Sıkma Vidası Clamp Screw	Anahtar Torx Key
<b>TK90 AN.X 1607..</b>								
TK90 AN16 D50 A22 Z04-H	50	4	22	40	15	<b>AN.X 1607.. TGTC UCA UYGUNDUR FOR TGTC INSERT</b>	<b>SSV M4x10 9514</b>	<b>T15</b>
TK90 AN16 D63 A22 Z06-H	63	6	22	40	15			
TK90 AN16 D80 A27 Z07-H	80	7	27	50	15			
TK90 AN16 D100 A32 Z08-H	100	8	32	50	15			





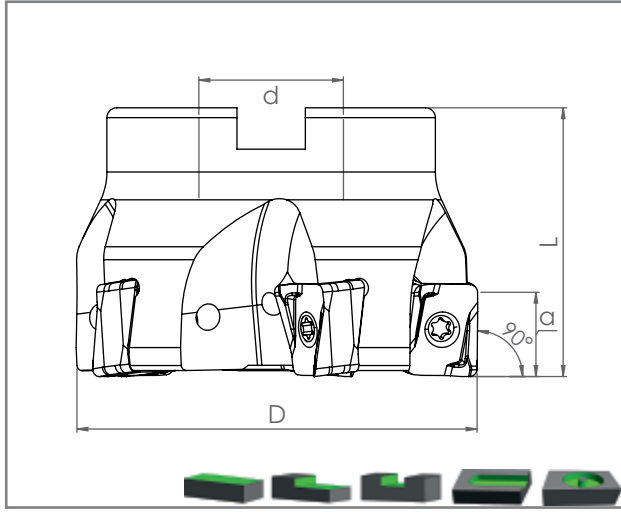

KOD CODE	ÖLÇÜLER DIMENSION (mm)					KESİCİ UÇ INSERT	YEDEK PARÇALAR SPARE PARTS	
	D	Z	d	L	a		Sıkma Vidası Clamp Screw	Anahtar Torx Key
<b>TK90 LN.HU 0904..</b>								
TK90 LN09 D40 A16 Z05-H	40	5	16	40	8	<b>LN.HU 0904.. WLTR UCA UYGUNDUR FOR WLTR INSERT</b>	<b>SSV M3x8 9508</b>	<b>T08</b>
TK90 LN09 D50 A22 Z06-H	50	6	22	40	8			
TK90 LN09 D63 A22 Z07-H	63	7	22	40	8			
TK90 LN09 D80 A27 Z09-H	80	9	27	50	8			

## YÜZEY FREZELER Face Milling Cutter

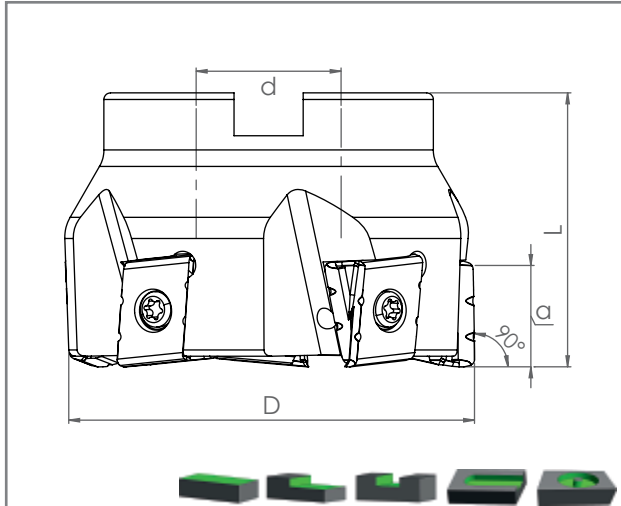

KOD CODE	ÖLÇÜLER DIMENSION (mm)					KESİCİ UÇ INSERT	YEDEK PARÇALAR SPARE PARTS	
	D	Z	d	L	a		Sıkma Vidası Clamp Screw	Anahtar Torx Key
<b>TK90 ANGX 1105 / 1506..</b>								
TK90 AN11 D40 A16 Z05-H	40	5	16	40	11	<b>ANGX 1105.. ZCC-CT UCA UYGUNDUR FOR ZCC-CT INSERT</b>	SSV M3x8 9508	T08
TK90 AN11 D50 A22 Z06-H	50	6	22	40	11			
TK90 AN11 D63 A22 Z07-H	63	7	22	40	11			
TK90 AN15 D50 A22 Z04-H	50	4	22	40	14	<b>ANGX 1506.. ZCC-CT UCA UYGUNDUR FOR ZCC-CT INSERT</b>	SSV M4x12 9515	T15
TK90 AN15 D63 A22 Z05-H	63	5	22	40	14			
TK90 AN15 D80 A27 Z07-H	80	7	27	50	14			
TK90 AN15 D100 A32 Z09-H	100	9	32	50	14			





KOD CODE	ÖLÇÜLER DIMENSION (mm)					KESİCİ UÇ INSERT	YEDEK PARÇALAR SPARE PARTS	
	D	Z	d	L	a		Sıkma Vidası Clamp Screw	Anahtar Torx Key
<b>TK90 LNKT 1506..</b>								
TK90 LNKT15 D50 A22 Z04-H	50	4	22	40	12	<b>LNKT 1506.. ZCC-CT UCA UYGUNDUR FOR ZCC-CT INSERT</b>	SSV M4x12 9515	T15
TK90 LNKT15 D63 A22 Z05-H	63	5	22	40	12			
TK90 LNKT15 D80 A27 Z06-H	80	6	27	50	12			
TK90 LNKT15 D100 A32 Z07-H	100	7	32	50	12			
TK90 LNKT15 D125 B40 Z08	125	8	40	63	12			

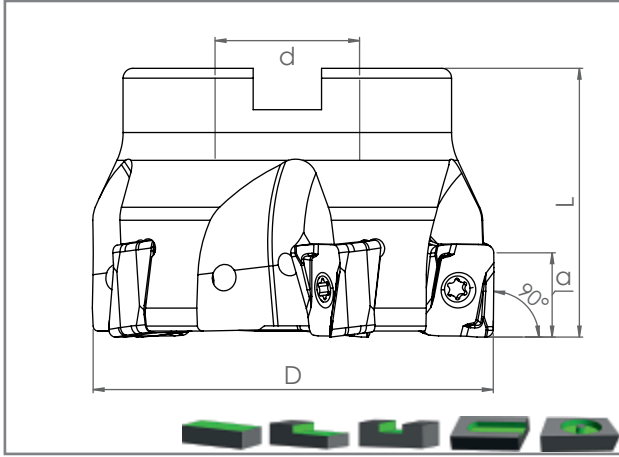

H-İÇTEN SU VERMELİ  
H-WITH COOLANT HOLE

## YÜZEY FREZELER Face Milling Cutter

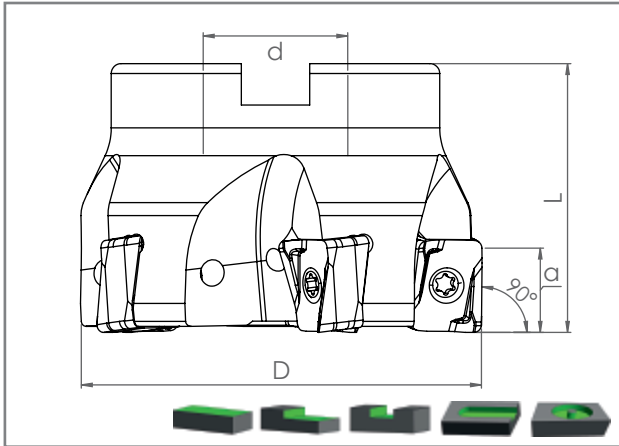

KOD CODE	ÖLÇÜLER DIMENSION (mm)					KESİCİ UÇ INSERT	YEDEK PARÇALAR SPARE PARTS	
	D	Z	d	L	a		Sıkma Vidası Clamp Screw	Anahtar Torx Key
<b>TK90 LNG. 1205..</b>								
TK90 LN12 D50 A22 Z05-H	50	5	22	40	12	<b>LNG. 1205.. PRMT UCA UYGUNDUR FOR PRMT INSERT</b>	<b>SSV M4x10 9514</b>	<b>T15</b>
TK90 LN12 D63 A22 Z06-H	63	6	22	40	12			
TK90 LN12 D80 A27 Z07-H	80	7	27	50	12			
TK90 LN12 D100 A32 Z09-H	100	9	32	50	12			





KOD CODE	ÖLÇÜLER DIMENSION (mm)					KESİCİ UÇ INSERT	YEDEK PARÇALAR SPARE PARTS	
	D	Z	d	L	a		Sıkma Vidası Clamp Screw	Anahtar Torx Key
<b>TK90 AN.X 1205 / 1706..</b>								
TK90 AN12 D50 A22 Z04-H	50	4	22	40	12	<b>AN.X 1205.. ISCR UCA UYGUNDUR FOR ISCR INSERT</b>	<b>SSV M4x12 9515</b>	<b>T15</b>
TK90 AN12 D63 A22 Z05-H	63	5	22	40	12			
TK90 AN12 D80 A27 Z07-H	80	7	27	50	12			
TK90 AN12 D100 A32 Z09-H	100	9	32	50	12			
TK90 AN17 D50 A22 Z04-H	50	4	22	40	16.30	<b>AN.X 1706.. ISCR UCA UYGUNDUR FOR ISCR INSERT</b>	<b>SSV M5x13 9519</b>	<b>T20</b>
TK90 AN17 D63 A22 Z06-H	63	6	22	40	16.30			
TK90 AN17 D80 A27 Z07-H	80	7	27	50	16.30			
TK90 AN17 D100 A32 Z08-H	100	8	32	50	16.30			
TK90 AN17 D125 B40 Z10	125	10	40	63	16.30			



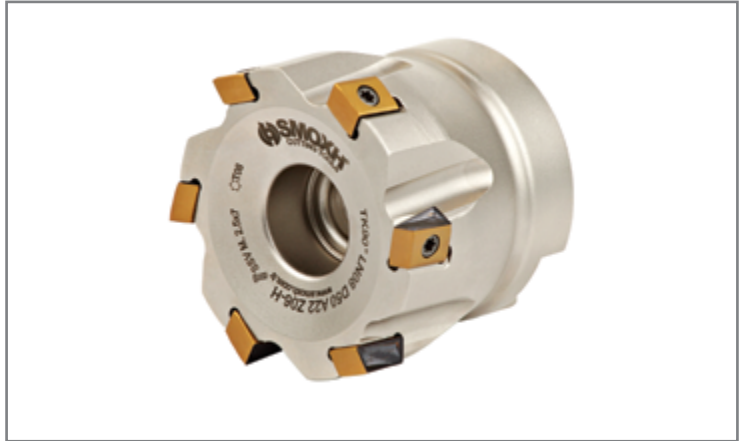
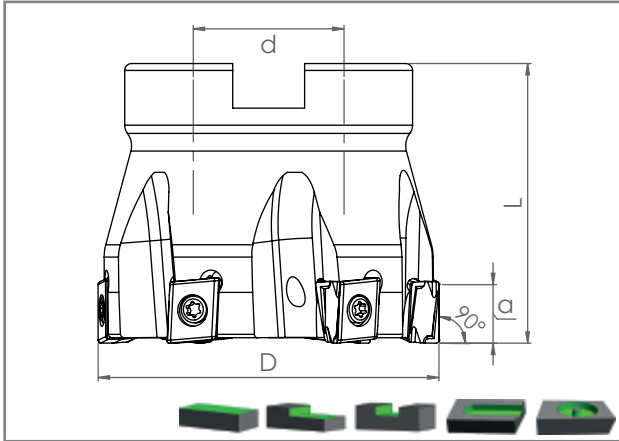

## YÜZEY FREZELER Face Milling Cutter

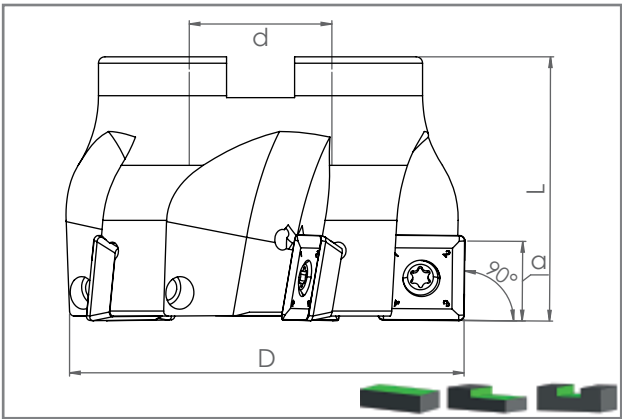

KOD CODE	ÖLÇÜLER DIMENSION (mm)					KESİCİ UÇ INSERT	YEDEK PARÇALAR SPARE PARTS	
	D	Z	d	L	a		Sıkma Vidası Clamp Screw	Anahtar Torx Key
<b>TK90 LN.. 0804 / 1306..</b>								
TK90 LN08 D40 A16 Z05-H	40	5	16	40	7	<b>LN.. 0804.. ISCR UCA UYGUNDUR FOR ISCR INSERT</b>	<b>SSV M2.5x7 9506</b>	<b>T08</b>
TK90 LN08 D50 A22 Z06-H	50	6	22	40	7			
TK90 LN08 D63 A22 Z08-H	63	8	22	40	7			
TK90 LN08 D80 A27 Z09-H	80	9	27	50	7			
TK90 LN13 D50 A22 Z05-H	50	5	22	40	12.50	<b>LN.. 1306.. ISCR UCA UYGUNDUR FOR ISCR INSERT</b>	<b>SSV M4x12 9515</b>	<b>T15</b>
TK90 LN13 D63 A22 Z06-H	63	6	22	40	12.50			
TK90 LN13 D80 A27 Z08-H	80	8	27	50	12.50			
TK90 LN13 D100 A32 Z09-H	100	9	32	50	12.50			
TK90 LN13 D125 B40 Z10	125	10	40	63	12.50			



KOD CODE	ÖLÇÜLER DIMENSION (mm)					KESİCİ UÇ INSERT	YEDEK PARÇALAR SPARE PARTS	
	D	Z	d	L	a		Sıkma Vidası Clamp Screw	Anahtar Torx Key
<b>TK90 R290.12 / SE12T3</b>								
TK90 R290.12 D50 A22 Z04-H	50	4	22	40	12	<b>R290.12 / SE..12T3.. SDVK / ZCC-CT UCA UYGUNDUR FOR SDVK / ZCC-CT INSERT</b>	<b>SSV M3.5x10 9511</b>	<b>T15</b>
TK90 R290.12 D63 A22 Z05-H	63	5	22	40	12			
TK90 R290.12 D80 A27 Z07-H	80	7	27	50	12			
TK90 R290.12 D100 A32 Z09-H	100	9	32	50	12			
TK90 R290.12 D125 B40 Z11	125	11	40	63	12			

H-İÇTEN SU VERMELİ  
H-WITH COOLANT HOLE

## YÜZEY FREZELER Face Milling Cutter

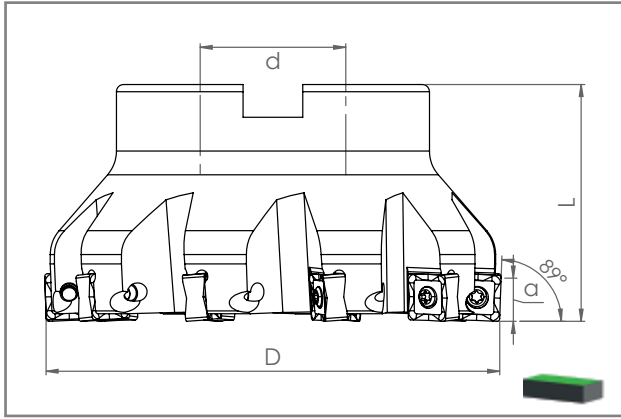

KOD CODE	ÖLÇÜLER DIMENSION (mm)					KESİCİ UÇ INSERT	YEDEK PARÇALAR SPARE PARTS	
	D	Z	d	L	a		Sıkma Vidası Screw	Anahtar Torx Key
<b>TK89 SN.. 1206..</b>								
TK89 SN12 D63 A22 Z06-H	63	6	22	40	10	SN..1206.. ISO UCA UYGUNDUR FOR ISO INSERT	SSV M4x12 9515	T15
TK89L SN12 D63 A22 Z06-H	63	6	22	40	10			
TK89 SN12 D80 A27 Z07-H	80	7	27	50	10			
TK89L SN12 D80 A27 Z07-H	80	7	27	50	10			
TK89 SN12 D100 A32 Z09-H	100	9	32	50	10			
TK89 SN12 D125 B40 Z10	125	10	40	63	10			
TK89 SN12 D160 C40 Z11	160	11	40	63	10			
TK89 SN12 D200 B60 Z14	200	14	60	63	10			

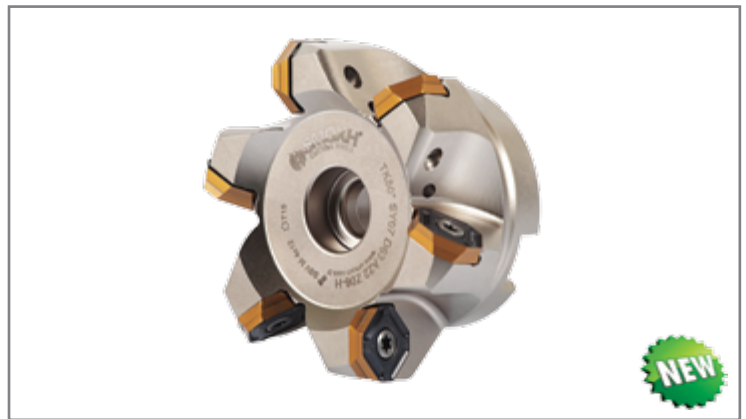
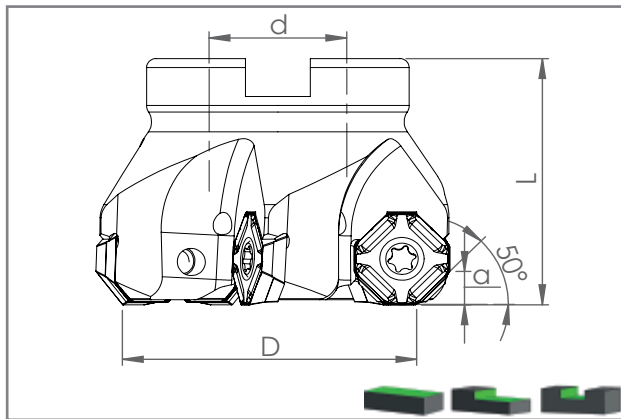

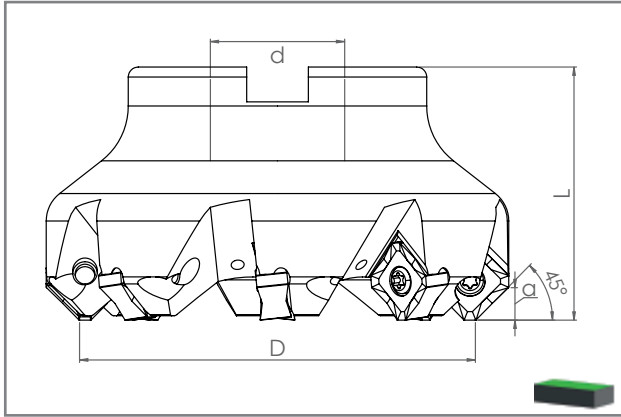

KOD CODE	ÖLÇÜLER DIMENSION (mm)					KESİCİ UÇ INSERT	YEDEK PARÇALAR SPARE PARTS	
	D	Z	d	L	a		Sıkma Vidası Clamp Screw	Anahtar Torx Key
<b>TK50 SYHU 0704..</b>								
TK50 SY07 D50 A22 Z05-H	50	5	22	40	4.60	SYHU 0704.. ISCR UCA UYGUNDUR ISCR INSERT	SSV M4x12 9515	T15
TK50 SY07 D63 A22 Z06-H	63	6	22	40	4.60			
TK50 SY07 D80 A27 Z07-H	80	7	27	50	4.60			
TK50 SY07 D100 A32 Z08-H	100	8	32	50	4.60			

## YÜZEY FREZELER Face Milling Cutter

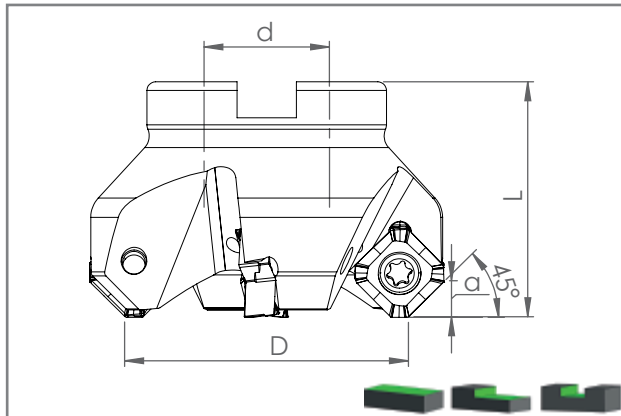

KOD CODE	ÖLÇÜLER DIMENSION (mm)					KESİCİ UÇ INSERT	YEDEK PARÇALAR SPARE PARTS	
	D	Z	d	L	a		Sıkma Vidası Clamp Screw	Anahtar Torx Key
<b>TK45 SN.. 1206..</b>								
TK45 SN12 D50 A22 Z05-H	50	5	22	40	6	SN..1206.. ISO UCA UYGUNDUR FOR ISO INSERT	SSV M4x12 9515	T15
TK45L SN12 D50 A22 Z05-H	50	5	22	40	6			
TK45 SN12 D63 A22 Z07-H	63	7	22	40	6			
TK45L SN12 D63 A22 Z07-H	63	7	22	40	6			
TK45 SN12 D80 A27 Z08-H	80	8	27	50	6			
TK45L SN12 D80 A27 Z08-H	80	8	27	50	6			
TK45 SN12 D100 A32 Z10-H	100	10	32	50	6			
TK45 SN12 D125 B40 Z11	125	11	40	63	6			
TK45 SN12 D160 C40 Z12	160	12	40	63	6			
TK45 SN12 D200 B60 Z14	200	14	60	63	6			
TK45 SN12 D315 D60 Z20	315	20	60	63	6			

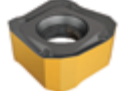

KOD CODE	ÖLÇÜLER DIMENSION (mm)					KESİCİ UÇ INSERT	YEDEK PARÇALAR SPARE PARTS	
	D	Z	d	L	a		Sıkma Vidası Clamp Screw	Anahtar Torx Key
<b>TK45 SNMU 1305..</b>								
TK45 SN13 D50 A22 Z04-H	50	4	22	40	6	SNMU 1305.. ISCR UCA UYGUNDUR ISCR INSERT	SSV M4x12x6 9517	T15
TK45 SN13 D63 A22 Z06-H	63	6	22	40	6			
TK45 SN13 D80 A27 Z07-H	80	7	27	50	6			
TK45 SN13 D100 A32 Z9-H	100	9	32	50	6			

H-İÇTEN SU VERMELİ  
H-WITH COOLANT HOLE

## YÜZEY FREZELER Face Milling Cutter

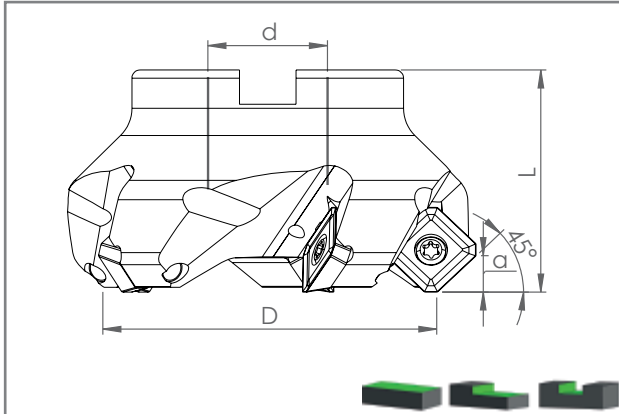



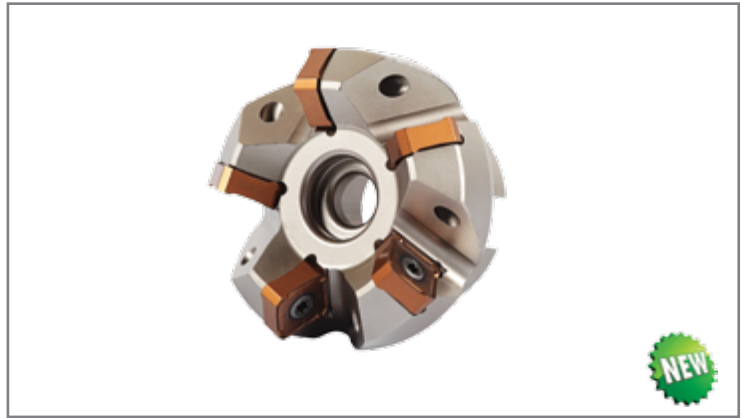
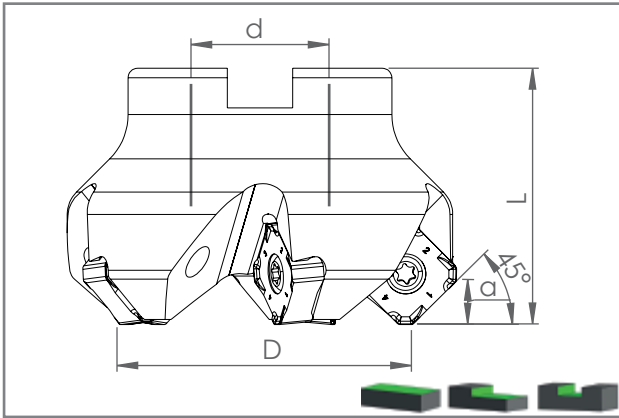

KOD CODE	ÖLÇÜLER DIMENSION (mm)					KESİCİ UÇ INSERT	YEDEK PARÇALAR SPARE PARTS	
	D	Z	d	L	a		Sıkma Vidası Clamp Screw	Anahtar Torx Key
<b>TK45 SEMT 13T3..</b>								
TK45 SE13 D50 A22 Z04-H	50	4	22	40	6			
TK45 SE13 D63 A22 Z05-H	63	5	22	40	6			
TK45 SE13 D80 A27 Z06-H	80	6	27	50	6			



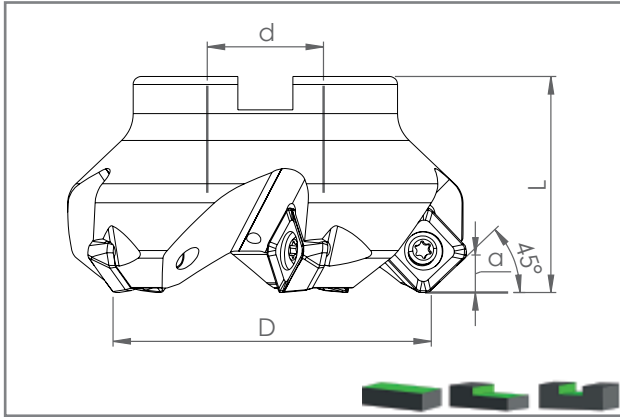



KOD CODE	ÖLÇÜLER DIMENSION (mm)					KESİCİ UÇ INSERT	YEDEK PARÇALAR SPARE PARTS	
	D	Z	d	L	a		Sıkma Vidası Clamp Screw	Anahtar Torx Key
<b>TK45 345-13..</b>								
TK45 R345-13 D50 A22 Z05-H	50	5	22	40	6			
TK45 R345-13 D63 A22 Z06-H	63	6	22	40	6			
TK45 R345-13 D80 A27 Z07-H	80	7	27	50	6			
TK45 R345-13 D100 A32 Z09-H	100	9	32	50	6			

## YÜZEY FREZELER Face Milling Cutter

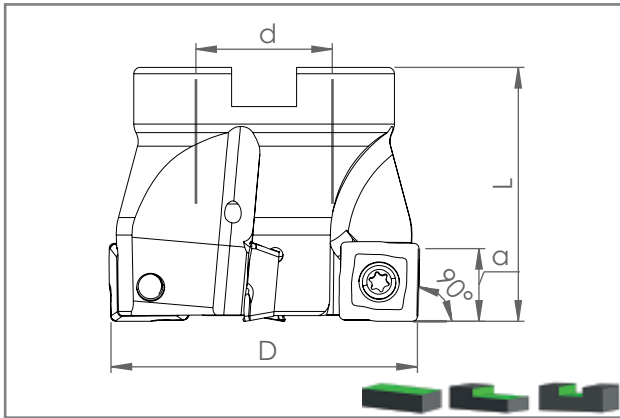

KOD CODE	ÖLÇÜLER DIMENSION (mm)					KESİCİ UÇ INSERT	YEDEK PARÇALAR SPARE PARTS	
	D	Z	d	L	a		Sıkma Vidası Clamp Screw	Anahtar Torx Key
<b>TK45 SNMT 1205..</b>								
TK45 SNMT12 D50 A22 Z04-H	50	4	22	40	6.5	SNMT 1205.. PRMT UCA UYGUNDUR PRMT INSERT	SSV M4x12x6 9517	T15
TK45 SNMT12 D63 A22 Z05-H	63	5	22	40	6.5			
TK45 SNMT12 D80 A32 Z06-H	80	6	27	50	6.5			
TK45 SNMT12 D100 A32 Z07-H	100	7	32	50	6.5			
TK45 SNMT12 D125 B40 Z08	125	8	40	63	6.5			
TK45 SNMT12 D160 C40 Z10	160	10	40	63	6.5			



KOD CODE	ÖLÇÜLER DIMENSION (mm)					KESİCİ UÇ INSERT	YEDEK PARÇALAR SPARE PARTS	
	D	Z	d	L	a		Sıkma Vidası Clamp Screw	Anahtar Torx Key
<b>TK45 SDMT 1205..</b>								
TK90 SDMT12 D50 A22 Z04-H	50	4	22	40	10	SDMT 1205.. PRMT UCA UYGUNDUR PRMT INSERT	SSV M4x12 9515	T15
TK90 SDMT12 D63 A22 Z05-H	63	5	22	40	10			
TK90 SDMT12 D80 A27 Z06-H	80	6	27	50	10			
TK90 SDMT12 D100 A32 Z08-H	100	8	32	50	10			
TK90 SDMT12 D125 C40 Z09	125	9	40	63	10			

## YÜZEY FREZELER Face Milling Cutter

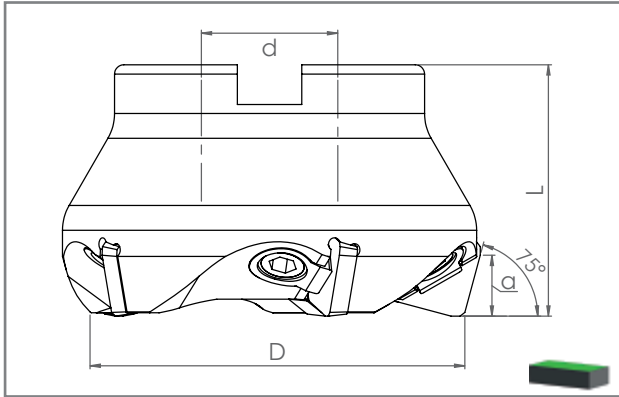

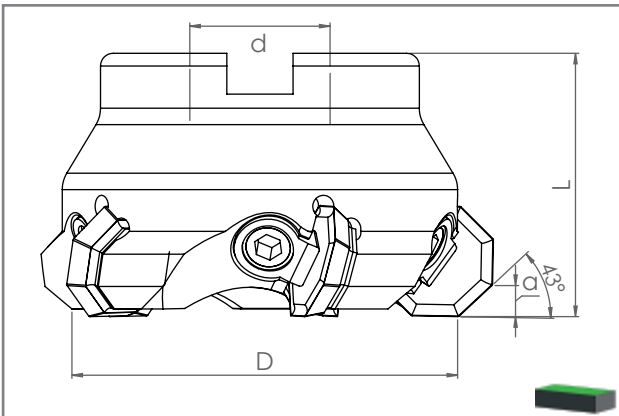

KOD CODE	ÖLÇÜLER DIMENSION (mm)					KESİCİ UÇ INSERT	YEDEK PARÇALAR SPARE PARTS		
	D	Z	d	L	a		Baskı Parçası Clamp	Sıkma Vidası Screw	Anahtar Torx Key
<b>TK75 SPKN 1203.. ISO</b>									
TK75 SP12 D50 A22 Z04	50	4	22	40	9.5	SPKN 1203.. ISO UCA UYGUNDUR FOR ISO INSERT	TKBP 9116	TKSV M8x1x18 9227	AA5
TK75 SP12 D63 A22 Z05	63	5	22	40	9.5				
TK75 SP12 D80 A27 Z06	80	6	27	50	9.5				
TK75 SP12 D100 A32 Z07	100	7	32	50	9.5				
TK75 SP12 D125 B40 Z08	125	8	40	63	9.5				
TK75 SP12 D160 C40 Z09	160	9	40	63	9.5				
TK75 SP12 D200 B60 Z12	200	12	60	63	9.5				
TK75 SP12 D315 D60 Z18	315	18	60	63	9.5				



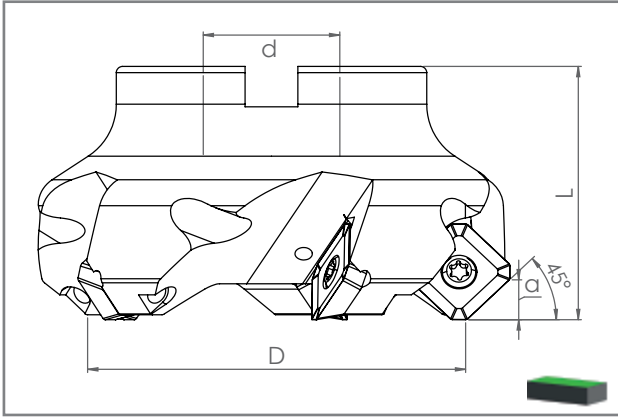

KOD CODE	ÖLÇÜLER DIMENSION (mm)					KESİCİ UÇ INSERT	YEDEK PARÇALAR SPARE PARTS		
	D	Z	d	L	a		Baskı Parçası Clamp	Sıkma Vidası Screw	Anahtar Torx Key
<b>TK43 OF.. 07T3.. ISO</b>									
TK43 OF07T3 D63 A22 Z05	63	5	22	40	3	OF..07T3.. ISO UCA UYGUNDUR FOR ISO INSERT	TKBP 9116	TKSV M8x1x18 9227	AA4
TK43 OF07T3 D80 A27 Z06	80	6	27	50	3				
TK43 OF07T3 D100 A32 Z07	100	7	32	50	3				
TK43 OF07T3 D125 B40 Z09	125	9	40	63	3				

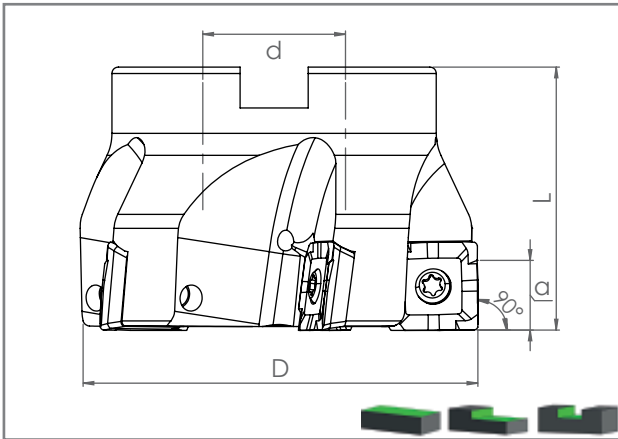

KOD CODE	ÖLÇÜLER DIMENSION (mm)					KESİCİ UÇ INSERT	YEDEK PARÇALAR SPARE PARTS	
	D	Z	d	L	a		Sıkma Vidası Clamp Screw	Anahtar Torx Key
<b>TK45 R245.12T3 SEET 12T3..</b>								
TK45 SE12 D50 A22 Z04-H	50	4	22	40	6	R245.12T3 / SEET 12T3.. SDVK / ZCC-CT UCA UYGUNDUR FOR SDVK / ZCC-CT INSERT	SSV M3.5x10 9511	T15
TK45 SE12 D63 A22 Z05-H	63	5	22	40	6			
TK45 SE12 D80 A27 Z06-H	80	6	27	50	6			
<b>TK45 SE12 D80 A27 Z09-H</b>	80	9	27	50	6			
TK45 SE12 D100 A32 Z07-H	100	7	32	50	6			
TK45 SE12 D125 B40 Z08	125	8	40	63	6			
TK45 SE12 D160 C40 Z10	160	10	40	63	6			



KOD CODE	ÖLÇÜLER DIMENSION (mm)					KESİCİ UÇ INSERT	YEDEK PARÇALAR SPARE PARTS	
	D	Z	d	L	a		Sıkma Vidası Clamp Screw	Anahtar Torx Key
<b>TK90 490R 08T3 / 1404</b>								
TK90 490R-08 D40 A16 Z04-H	40	4	16	40	5.5	490R-08T3 SDVK UCA UYGUNDUR FOR SDVK INSERT	SSV M2.5x7 9506	T08
<b>TK90 490R-08 D50 A22 Z05-H</b>	50	5	22	40	5.5			
TK90 490R-08 D63 A22 Z06-H	63	6	22	50	5.5			
TK90 490R-14 D50 A22 Z04-H	50	4	22	40	10.6	490R-1404 SDVK UCA UYGUNDUR FOR SDVK INSERT	SSV M3.5x10 9511	T15
TK90 490R-14 D63 A22 Z05-H	63	5	22	40	10.6			
TK90 490R-14 D80 A27 Z07-H	80	7	27	50	10.6			

## YÜZEY FREZELER Face Milling Cutter

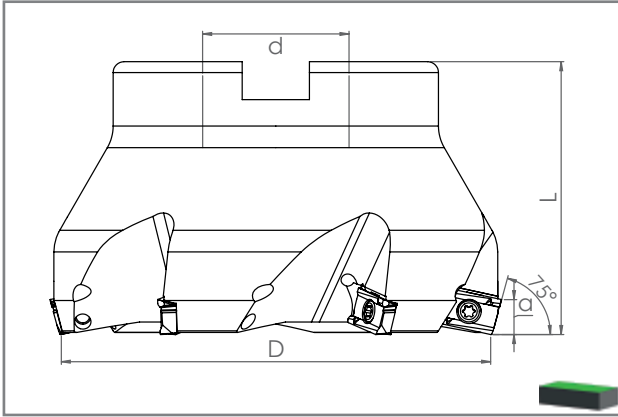

KOD CODE	ÖLÇÜLER DIMENSION (mm)					KESİCİ UÇ INSERT	YEDEK PARÇALAR SPARE PARTS	
	D	Z	d	L	a		Sıkma Vidası Clamp Screw	Anahtar Torx Key
<b>TK75 APKT 1003 / 1604.. ISO</b>								
TK75 AP10 D63 A22 Z05-H	63	5	22	40	5	AP.1003.. ISO UCA UYGUNDUR FOR ISO INSERT	SSV M2.5x7 9506	T08
TK75 AP10 D80 A27 Z06-H	80	6	27	50	5			
TK75 AP10 D100 A32 Z07-H	100	7	32	50	5			
TK75 AP16 D63 A22 Z05-H	63	5	22	40	10	AP.1604.. ISO UCA UYGUNDUR FOR ISO INSERT	SSV M3.5x10 9511	T15
TK75 AP16 D80 A27 Z06-H	80	6	27	50	10			
TK75 AP16 D100 A32 Z07-H	100	7	32	50	10			
TK75 AP16 D125 B40 Z08	125	8	40	63	10			

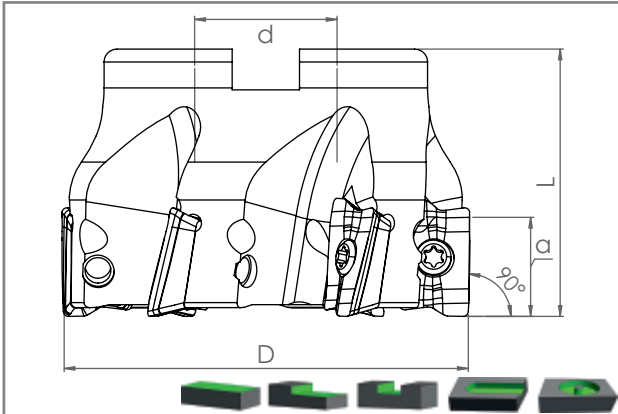



KOD CODE	ÖLÇÜLER DIMENSION (mm)					KESİCİ UÇ INSERT	YEDEK PARÇALAR SPARE PARTS	
	D	Z	d	L	a		Sıkma Vidası Clamp Screw	Anahtar Torx Key
<b>TK90 APKT 1705..</b>								
TK90 AP17 D50 A22 Z05-H	50	5	22	40	16	APKT 1705.. TGTC UCA UYGUNDUR FOR TGTC INSERT	SSV M4x10 9514	T15
TK90 AP17 D63 A22 Z06-H	63	6	22	40	16			
TK90 AP17 D80 A27 Z07-H	80	7	27	50	16			
TK90 AP17 D100 A32 Z09-H	100	9	32	50	16			



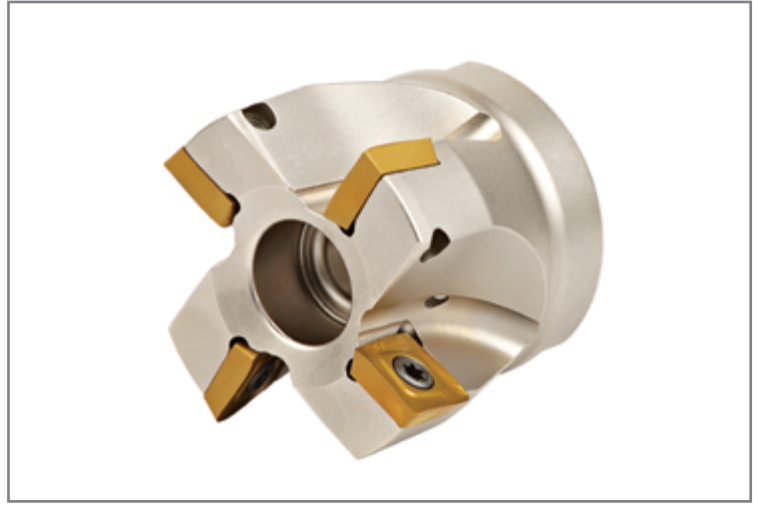
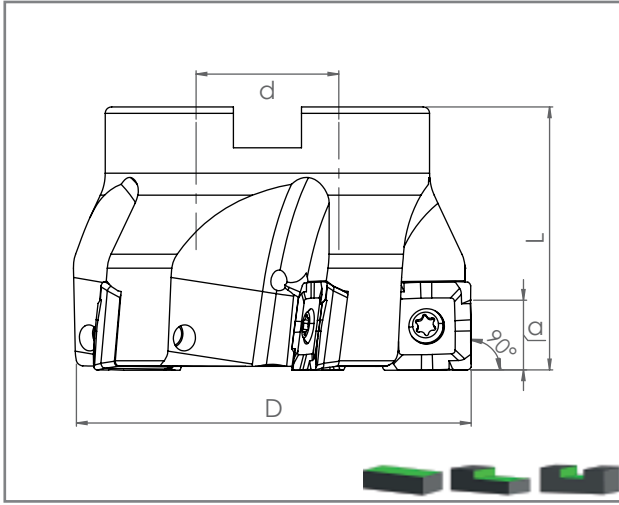



## YÜZEY FREZELER Face Milling Cutter

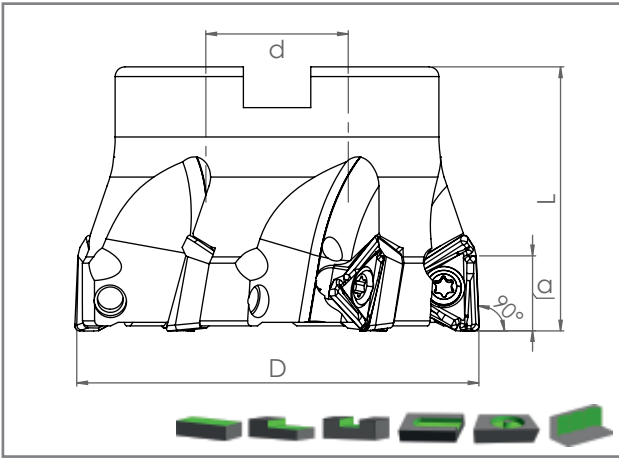

KOD CODE	ÖLÇÜLER DIMENSION (mm)					KESİCİ UÇ INSERT	YEDEK PARÇALAR SPARE PARTS	
	D	Z	d	L	a		Sıkma Vidası Clamp Screw	Anahtar Torx Key
<b>TK90 SOMT 12T3..</b>								
TK90 SO12 D50 A22 Z04-H	50	4	22	40	11	<b>SOMT 12T3.. MTSBSH UCA UYGUNDUR FOR MTSBSH INSERT</b>	<b>SSV M3.5x10 9511</b>	<b>T15</b>
TK90 SO12 D63 A22 Z05-H	63	5	22	40	11			
TK90 SO12 D80 A27 Z07-H	80	7	27	50	11			





KOD CODE	ÖLÇÜLER DIMENSION (mm)					KESİCİ UÇ INSERT	YEDEK PARÇALAR SPARE PARTS	
	D	Z	d	L	a		Sıkma Vidası Clamp Screw	Anahtar Torx Key
<b>TK90 3PKT 1004 / 1505..</b>								
TK90 3PKT10 D40 A16 Z05-H	40	5	16	40	7	<b>3PKT 1004.. TGTC UCA UYGUNDUR FOR TGTC INSERT</b>	<b>SSV M2.5x7 9506</b>	<b>T08</b>
TK90 3PKT10 D50 A22 Z06-H 	50	6	22	40	7			
TK90 3PKT10 D63 A22 Z07-H	63	7	22	40	7			
TK90 3PKT15 D50 A22 Z05-H	50	5	22	40	11	<b>3PKT 1505.. TGTC UCA UYGUNDUR FOR TGTC INSERT</b>	<b>SSV M4x10 9514</b>	<b>T15</b>
TK90 3PKT15 D63 A22 Z06-H	63	6	22	40	11			
TK90 3PKT15 D80 A27 Z08-H	80	8	27	50	11			
TK90 3PKT15 D100 A32 Z09 	100	9	32	50	11			
TK90 3PKT15 D125 B40 Z12	125	12	40	63	11			

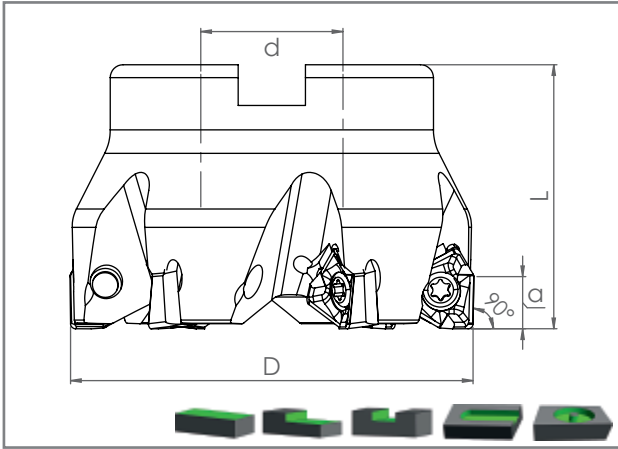

H-İÇTEN SU VERMELİ  
H-WITH COOLANT HOLE

## YÜZEY FREZELER Face Milling Cutter

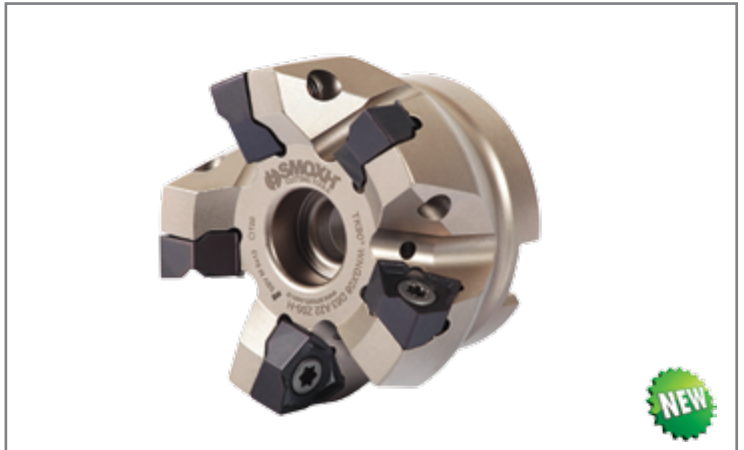
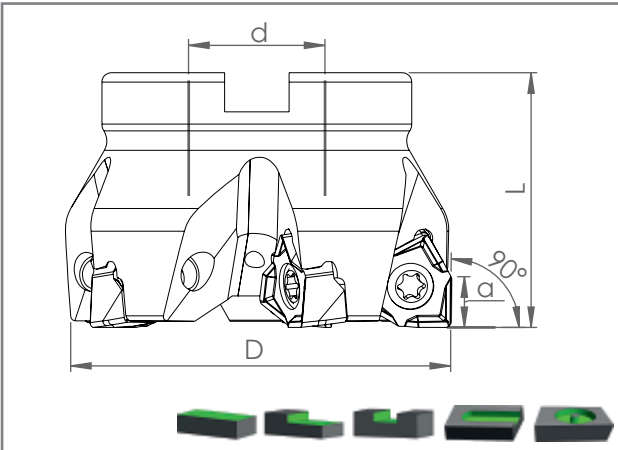

KOD CODE	ÖLÇÜLER DIMENSION (mm)					KESİCİ UÇ INSERT	YEDEK PARÇALAR SPARE PARTS	
	D	Z	d	L	a		Sıkma Vidası Clamp Screw	Anahtar Torx Key
<b>TK90 XNKT 0805 / 0808..</b>								
TK90 XNKT08 D40 A16 Z04-H	40	4	16	40	7	XNKT 0805 / 0808.. KRLY UCA UYGUNDUR FOR KRLY INSERT	SSV M4x10 9514	T15
TK90 XNKT08 D50 A22 Z05-H	50	5	22	40	7			
TK90 XNKT08 D63 A22 Z06-H	63	6	22	40	7			
TK90 XNKT08 D80 A27 Z07-H	80	7	27	50	7			
TK90 XNKT08 D100 A32 Z09-H	100	9	32	50	7			
TK90 XNKT08 D125 B40 Z10	125	10	40	63	7			





KOD CODE	ÖLÇÜLER DIMENSION (mm)					KESİCİ UÇ INSERT	YEDEK PARÇALAR SPARE PARTS	
	D	Z	d	L	a		Sıkma Vidası Clamp Screw	Anahtar Torx Key
<b>TK90 WNGX 0806..</b>								
TK90 WNGX08 D50 A22 Z04-H	50	4	22	40	8.2	WNGX0806.. KRLY UCA UYGUNDUR FOR KRLY INSERT	SSV M5x13 9519	T20
TK90 WNGX08 D63 A22 Z05-H	63	5	22	40	8.2			
TK90 WNGX08 D80 A27 Z06-H	80	6	27	50	8.2			
TK90 WNGX08 D100 A32 Z08-H	100	8	32	50	8.2			

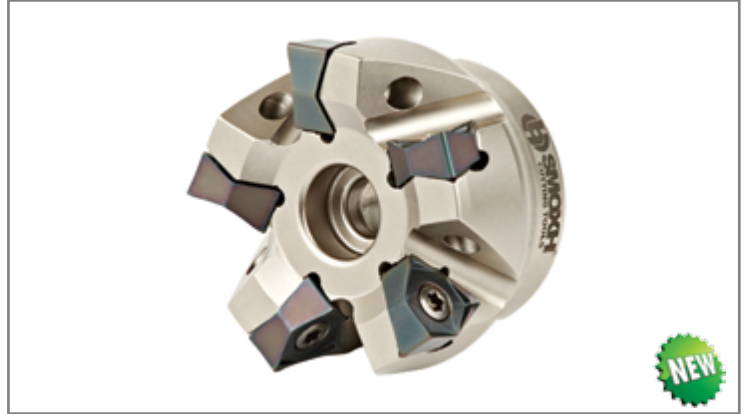
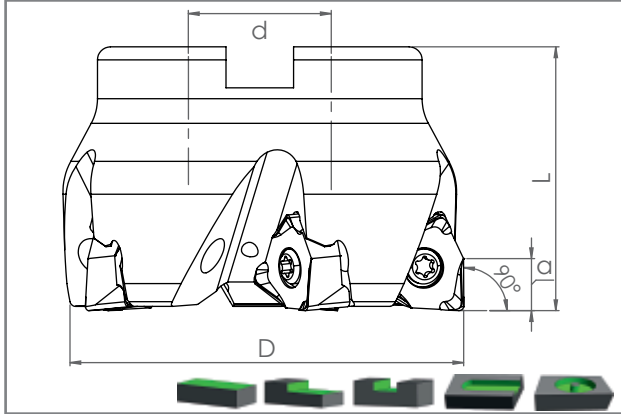

H-İÇTEN SU VERMELİ  
H-WITH COOLANT HOLE

## YÜZEY FREZELER Face Milling Cutter

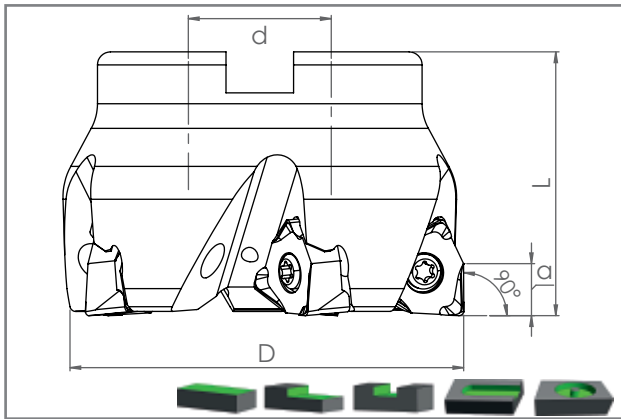

KOD CODE	ÖLÇÜLER DIMENSION (mm)					KESİCİ UÇ INSERT	YEDEK PARÇALAR SPARE PARTS	
	D	Z	d	L	a		Sıkma Vidası Clamp Screw	Anahtar Torx Key
<b>TK90 WNHU 0806..</b>								
TK90 WNHU08 D50 A22 Z04-H	50	4	22	40	7.5	WNHU 0806.. ZCC-CT UCA UYGUNDUR FOR ZCC-CT INSERT	SSV M4x12 9515	T15
TK90 WNHU08 D63 A22 Z05-H	63	5	22	40	7.5			
TK90 WNHU08 D80 A27 Z06-H	80	6	27	50	7.5			
TK90 WNHU08 D100 A32 Z08-H	100	8	32	50	7.5			





KOD CODE	ÖLÇÜLER DIMENSION (mm)					KESİCİ UÇ INSERT	YEDEK PARÇALAR SPARE PARTS	
	D	Z	d	L	a		Sıkma Vidası Clamp Screw	Anahtar Torx Key
<b>TK90 XNEX 0806..</b>								
TK90 XNEX08 D50 A22 Z04-H	50	4	22	40	7.5	XNEX 0806.. SECO / VNDRT UCA UYGUNDUR FOR SECO / VNDRT INSERT	SSV M4x12 9515	T15
TK90 XNEX08 D63 A22 Z05-H	63	5	22	40	7.5			
TK90 XNEX08 D80 A27 Z07-H	80	7	27	50	7.5			
TK90 XNEX08 D100 A32 Z08-H	100	8	32	50	7.5			
TK90 XNEX08 D125 B40 Z10	125	10	40	63	7.5			

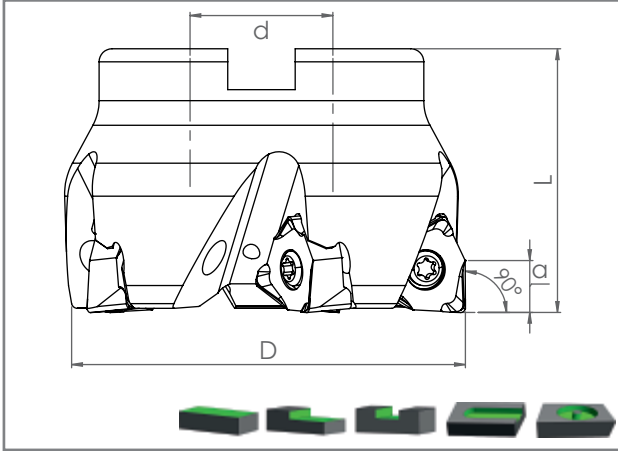

H-İÇTEN SU VERMELİ  
H-WITH COOLANT HOLE

## YÜZEY FREZELER Face Milling Cutter



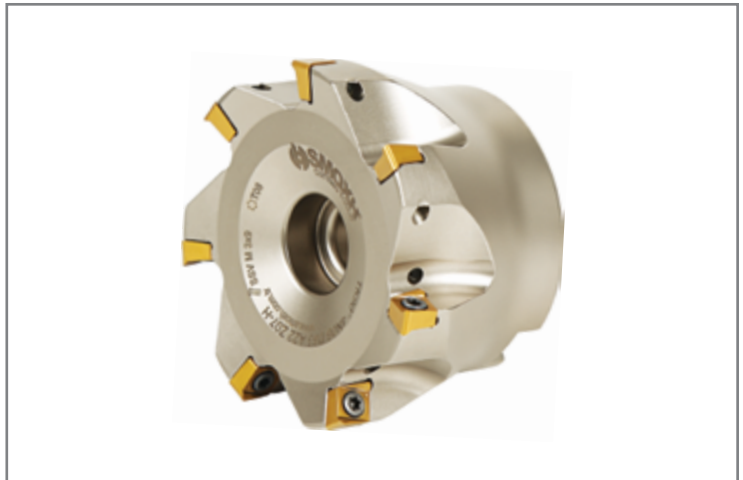
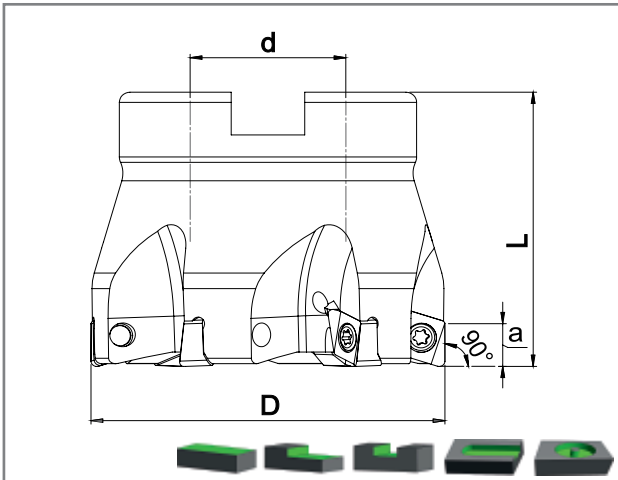



KOD CODE	ÖLÇÜLER DIMENSION (mm)					KESİCİ UÇ INSERT	YEDEK PARÇALAR SPARE PARTS	
	D	Z	d	L	a		Sıkma Vidası Clamp Screw	Anahtar Torx Key
<b>TK90 WN.. 0806..</b>								
TK90 WN08 D50 A22 Z04-H	50	4	22	40	8	<b>WN..0806.. KYCR UCA UYGUNDUR FOR KYCR INSERT</b>	<b>SSV M5x13 9519</b>	<b>T20</b>
TK90 WN08 D63 A22 Z05-H	63	5	22	40	8			
TK90 WN08 D80 A27 Z07-H	80	7	27	50	8			
TK90 WN08 D100 A32 Z08-H	100	8	32	50	8			
TK90 WN08 D125 B40 Z11	125	11	40	63	8			



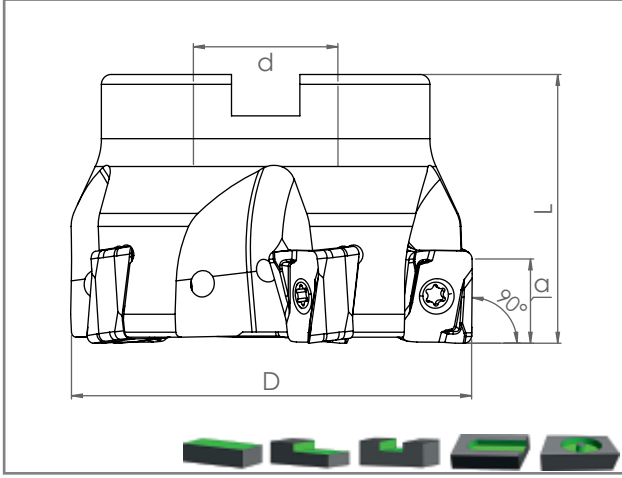



KOD CODE	ÖLÇÜLER DIMENSION (mm)					KESİCİ UÇ INSERT	YEDEK PARÇALAR SPARE PARTS	
	D	Z	d	L	a		Sıkma Vidası Clamp Screw	Anahtar Torx Key
<b>TK90 4NKT 0603..</b>								
TK90 4N06 D40 A16 Z05-H	40	5	16	40	6	<b>4NKT 0603.. TGTC UCA UYGUNDUR FOR TGTC INSERT</b>	<b>SSV M3x6 LG 9525</b>	<b>T08</b>
TK90 4N06 D50 A22 Z06-H	50	6	22	40	6			
TK90 4N06 D63 A22 Z07-H	63	7	22	40	6			

## YÜZEY FREZELER Face Milling Cutter

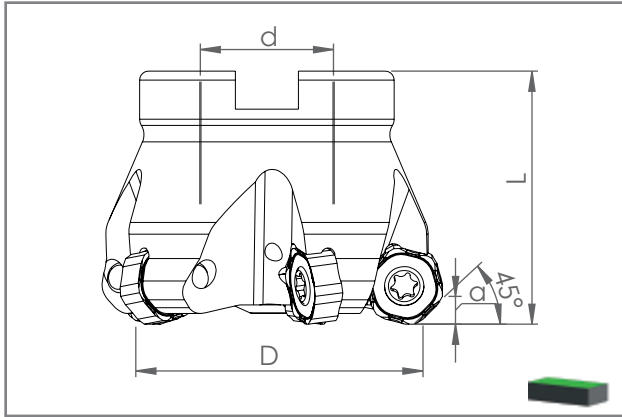

KOD CODE	ÖLÇÜLER DIMENSION (mm)					KESİCİ UÇ INSERT	YEDEK PARÇALAR SPARE PARTS	
	D	Z	d	L	a		Sıkma Vidası Clamp Screw	Anahtar Torx Key
<b>TK90 LNGX 1307..</b>								
TK90 LNGX13 D50 A22 Z04-H	50	4	22	40	12	LNGX 1307.. WLTR UCA UYGUNDUR FOR WLTR INSERT	SSV M3.5x10 9511	T15
TK90 LNGX13 D63 A22 Z05-H	63	5	22	40	12			
TK90 LNGX13 D80 A27 Z06-H	80	6	27	50	12			
TK90 LNGX13 D100 A32 Z07-H	100	7	32	50	12			
TK90 LNGX13 D125 B40 Z08	125	8	40	63	12			



KOD CODE	ÖLÇÜLER DIMENSION (mm)					KESİCİ UÇ INSERT	YEDEK PARÇALAR SPARE PARTS	
	D	Z	d	L	a		Sıkma Vidası Clamp Screw	Anahtar Torx Key
<b>TK45 HNKX 0604..</b>								
TK45 HNKX06 D50 A22 Z05-H	50	5	22	40	3.5	HNKX0604.. LMN UCA UYGUNDUR FOR LMN INSERT	SSV M4x12 9515	T15
TK45 HNKX06 D63 A22 Z06-H	63	6	22	40	3.5			
TK45 HNKX06 D80 A27 Z08-H	80	8	27	50	3.5			

## YÜZEY FREZELER Face Milling Cutter

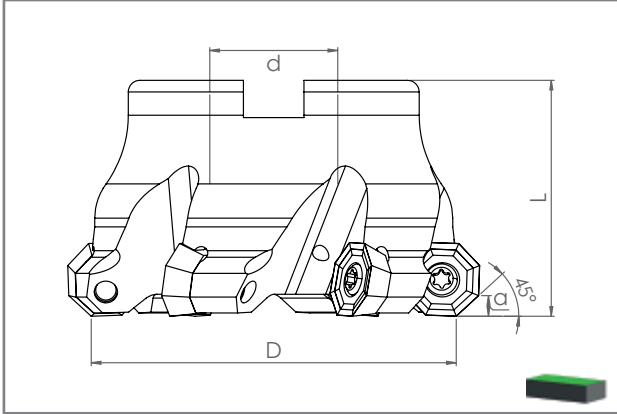



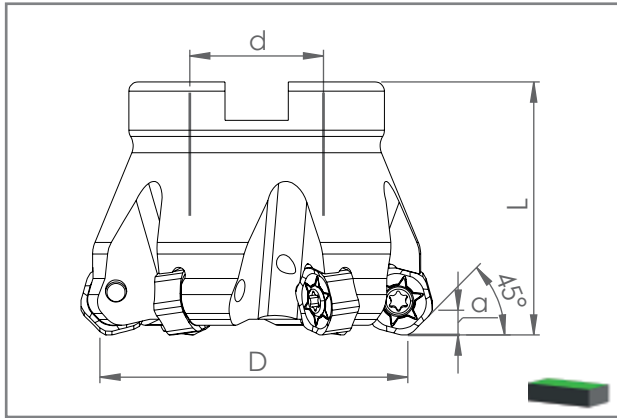



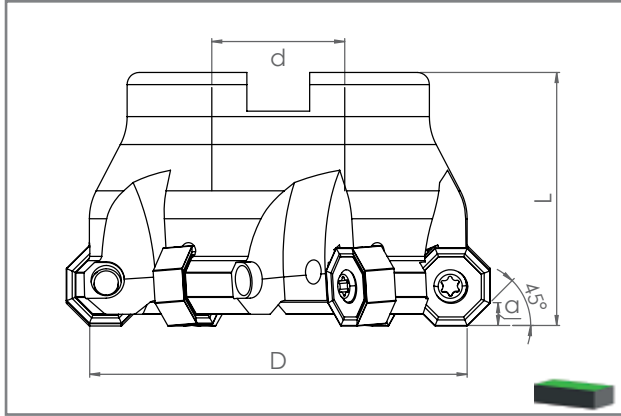

KOD CODE	ÖLÇÜLER DIMENSION (mm)					KESİCİ UÇ INSERT	YEDEK PARÇALAR SPARE PARTS	
	D	Z	d	L	a		Sıkma Vidası Clamp Screw	Anahtar Torx Key
<b>TK45 OD.. 0504</b>								
TK45 OD05 D40 A16 Z04-H	40	4	16	40	3.5	<b>OD.. 0504.. PRAMET UCA UYGUNDUR FOR PRAMET INSERT</b>	<b>SSV M3.5x10 9511</b>	<b>T15</b>
TK45 OD05 D50 A22 Z05-H	50	5	22	40	3.5			
TK45 OD05 D63 A22 Z06-H	63	6	22	40	3.5			
TK45 OD05 D80 A27 Z07-H	80	7	27	50	3.5			
TK45 OD05 D100 A32 Z08-H	100	8	32	50	3.5			



KOD CODE	ÖLÇÜLER DIMENSION (mm)					KESİCİ UÇ INSERT	YEDEK PARÇALAR SPARE PARTS	
	D	Z	d	L	a		Sıkma Vidası Clamp Screw	Anahtar Torx Key
<b>TK45 HNGX 0604 / 0906..</b>								
TK45 HN06 D50 A22 Z05-H	50	5	22	40	3	<b>HNGX 0604.. PRAMET UCA UYGUNDUR FOR PRAMET INSERT</b>	<b>SSV M3x8 9508</b>	<b>T08</b>
TK45 HN06 D63 A22 Z06-H	63	6	22	40	3			
TK45 HN06 D80 A27 Z07-H	80	7	27	50	3			
TK45 HN06 D100 A32 Z08-H	100	8	32	50	3			
TK45 HN09 D63 A22 Z05-H	63	5	22	40	5	<b>HNGX 0906.. PRAMET UCA UYGUNDUR FOR PRAMET INSERT</b>	<b>SSV M4x12 9515</b>	<b>T15</b>
TK45 HN09 D80 A27 Z06-H	80	6	27	50	5			
TK45 HN09 D100 A32 Z08-H	100	8	32	50	5			
TK45 HN09 D125 B40 Z10	125	10	40	63	5			
TK45 HN09 D160 C40 Z12	160	12	40	63	5			



## YÜZEY FREZELER Face Milling Cutter

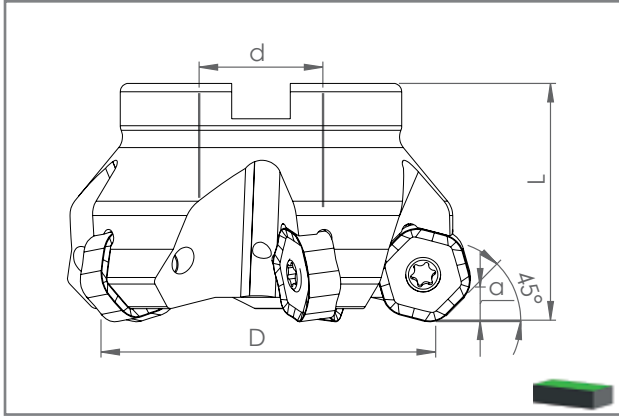

KOD CODE	ÖLÇÜLER DIMENSION (mm)					KESİCİ UÇ INSERT	YEDEK PARÇALAR SPARE PARTS	
	D	Z	d	L	a		Sıkma Vidası Clamp Screw	Anahtar Torx Key
<b>TK45 ON.X 0504 / 0606 / 0806..</b>								
TK45 ON05 D50 A22 Z05-H	50	5	22	40	2.5	ON.X 0504.. ISCR UCA UYGUNDUR FOR ISCR INSERT	SSV M5x13 9519	T20
TK45 ON05 D63 A22 Z06-H	63	6	22	40	2.5			
TK45 ON05 D80 A27 Z07-H	80	7	27	50	2.5			
TK45 ON05 D100 A32 Z08-H	100	8	32	50	2.5			
TK45 ON06 D63 A22 Z05-H	63	5	22	40	4	ON.X 0606.. KRLY UCA UYGUNDUR FOR KRLY INSERT	SSV M5x13 9519	T20
TK45 ON06 D80 A27 Z06-H	80	6	27	50	4			
TK45 ON06 D100 A32 Z07-H	100	7	32	50	4			
TK45 ON06 D125 B40 Z08	125	8	40	63	4			
TK45 ON08 D63 A22 Z05-H	63	5	22	40	5.5	ON.X 0806.. ISO UCA UYGUNDUR FOR ISO INSERT	SSV M5x13 9519	T20
TK45 ON08 D80 A27 Z06-H	80	6	27	50	5.5			
TK45 ON08 D100 A32 Z07-H	100	7	32	50	5.5			
TK45 ON08 D125 B40 Z08	125	8	40	63	5.5			
TK45 ON08 D160 C40 Z10	160	10	40	63	5.5			
TK45 ON08 D200 B60 Z12	200	12	60	63	5.5			
TK45 ONHU06 D63 A22 Z05-H 	63	5	22	40	4			
TK45 ONHU06 D80 A27 Z06-H 	80	6	27	50	4			
TK45 ONHU06 D100 A32 Z07-H	100	7	32	50	4			
TK45 ONHU08 D63 A22 Z05-H 	63	5	22	40	5	ONHU 08T6.. ZCC-CT UCA UYGUNDUR FOR ZCC-CT INSERT	SSV M5x13 9519	T20
TK45 ONHU08 D80 A27 Z06-H 	80	6	27	50	5			
TK45 ONHU08 D100 A32 Z07-H	100	7	32	50	5			

## YÜZEY FREZELER Face Milling Cutter



KOD CODE	ÖLÇÜLER DIMENSION (mm)					KESİCİ UÇ INSERT	YEDEK PARÇALAR SPARE PARTS	
	D	Z	d	L	a		Sıkma Vidası Clamp Screw	Anahtar Torx Key
<b>TK45 HN.J 0604 / 0704 / 0905..</b>								
TK45 HN0604 D50 A22 Z05-H	50	5	22	40	3.23	HN.J 0604.. KNMTL UCA UYGUNDUR FOR KNMTL INSERT	SSV M4x12 9515	T15
TK45 HN0604 D63 A22 Z06-H	63	6	22	40	3.23			
TK45 HN0604 D80 A27 Z07-H	80	7	27	50	3.23			
TK45 HN0704 D50 A22 Z05-H	50	5	22	40	3.5	HN.J 0704.. WIDIA UCA UYGUNDUR FOR WIDIA INSERT	SSV M4x12 9515	T15
TK45 HN0704 D63 A22 Z06-H	63	6	22	40	3.5			
TK45 HN0704 D80 A27 Z08-H	80	8	27	50	3.5			
TK45 HN0905 D50 A22 Z04-H	50	4	22	40	4.5	HN.J 0905.. KNMTL / WIDIA UCA UYGUNDUR FOR KNMTL / WIDIA INSERT	SSV M4x12 9515	T15
TK45 HN0905 D63 A22 Z05-H	63	5	22	40	4.5			
TK45 HN0905 D80 A27 Z06-H	80	6	27	50	4.5			
TK45 HN0905 D100 A32 Z08-H	100	8	32	50	4.5			
TK45 HN0905 D125 B40 Z10	125	10	40	63	4.5			
TK45 HN0905 D160 C40 Z12	160	12	40	63	4.5			



## YÜZEY FREZELER Face Milling Cutter

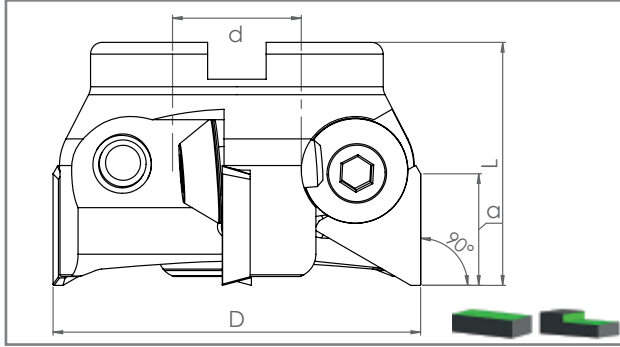

KOD CODE	ÖLÇÜLER DIMENSION (mm)					KESİCİ UÇ INSERT	YEDEK PARÇALAR SPARE PARTS	
	D	Z	d	L	a		Sıkma Vidası Clamp Screw	Anahtar Allen Key
<b>TK90 TPKN 1603 / 2205.. ISO</b>								
TK90 TP16 D50 A22 Z04	50	4	22	40	12	TPKN 1603.. ISO UCA UYGUNDUR FOR ISO INSERT	TPBV 6x10 9218	AA4
TK90 TP16 D63 A22 Z05	63	5	22	40	12			
TK90 TP16 D80 A27 Z06	80	6	27	50	12			
TK90 TP16 D100 A32 Z07	100	7	32	50	12			
TK90 TP16 D125 B40 Z08	125	8	40	63	12			
TK90 TP22 D63 A22 Z04	63	4	22	40	18	TPKN 2205.. ISO UCA UYGUNDUR FOR ISO INSERT	TPBV 8x10 9219	AA5
TK90 TP22 D80 A27 Z05	80	5	27	50	18			
TK90 TP22 D100 A32 Z06	100	6	32	50	18			
TK90 TP22 D125 B40 Z07	125	7	40	63	18			
TK90 TP22 D160 C40 Z08	160	8	40	63	18			

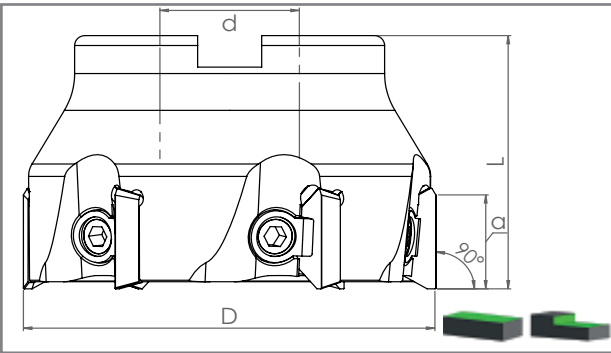

KOD CODE	ÖLÇÜLER DIMENSION (mm)					KESİCİ UÇ INSERT	YEDEK PARÇALAR SPARE PARTS		
	D	Z	d	L	a		Baskı Parçası Clamp	Sıkma Vidası Screw	Anahtar Torx Key
<b>TK90 TPKN 1603 / 2205.. ISO</b>									
TK90P TP16 D50 A22 Z04	50	4	22	40	12	TPKN 1603.. ISO UCA UYGUNDUR FOR ISO INSERT INSERT	TKBP 9116	TKSV M8x1x18 9227	AA5
TK90P TP16 D63 A22 Z06	63	6	22	40	12				
TK90P TP16 D80 A27 Z07	80	7	27	50	12				
TK90P TP16 D100 A32 Z08	100	8	32	50	12				
TK90P TP16 D125 C40 Z09	125	9	40	63	12				
TK90P TP22 D63 A22 Z05	63	5	22	40	18	TPKN 2205.. ISO UCA UYGUNDUR FOR ISO INSERT INSERT	TKBP 9116	TKSV M8x1x18 9227	AA5
TK90P TP22 D80 A27 Z06	80	6	27	50	18				
TK90P TP22 D100 A32 Z07	100	7	32	50	18				
TK90P TP22 D125 B40 Z08	125	8	40	63	18				
TK90P TP22 D160 C40 Z09	160	9	40	63	18				
TK90P TP22 D200 B60 Z12	200	12	60	63	18				
TK90P TP22 D315 D60 Z18	315	18	60	63	18				

## YÜZEY FREZELER

### Face Milling Cutter

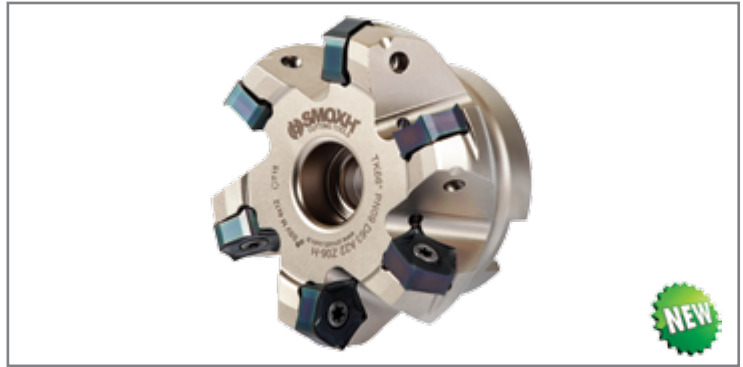
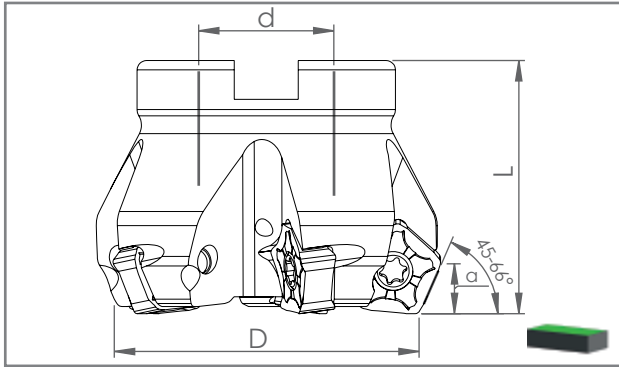

KOD CODE	ÖLÇÜLER DIMENSION (mm)					KESİCİ UÇ INSERT	YEDEK PARÇALAR SPARE PARTS	
	D	Z	d	L	a		Sıkma Vidası Clamp Screw	Anahtar Torx Key
<b>TK45 / TK66 PNMU 0905 / 1205..</b>								
TK66 PN09 D50 A22 Z05-H	50	5	22	40	6	PNMU0905.. KYCR UCA UYGUNDUR FOR KYCR INSERT	SSV M4X12 9515	T15
TK66 PN09 D63 A22 Z06-H	63	6	22	40	6			
TK66 PN09 D80 A27 Z08-H	80	8	27	50	6			
TK66 PN09 D100 A32 Z10-H	100	10	32	50	6			
TK66 PN09 D125 B40 Z12	125	12	40	63	6			
TK45 PN12 D63 A22 Z05-H	63	5	22	40	6	PNMU1205.. KYCR UCA UYGUNDUR FOR KYCR INSERT	SSV M5x13 9519	T20
TK45 PN12 D80 A27 Z07-H	80	7	27	50	6			
TK45 PN12 D100 A32 Z9-H	100	9	32	50	6			
TK45 PN12 D125 B40 Z11	125	11	40	63	6			

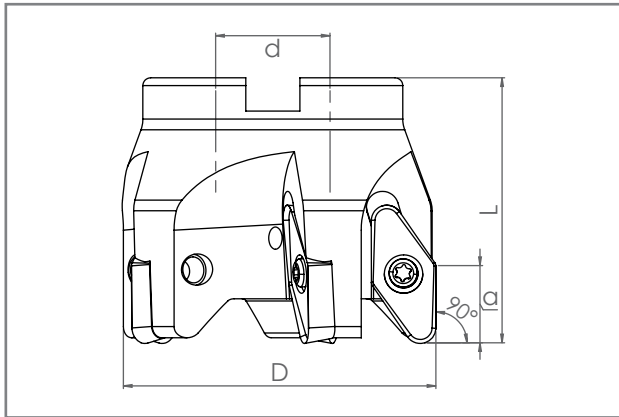



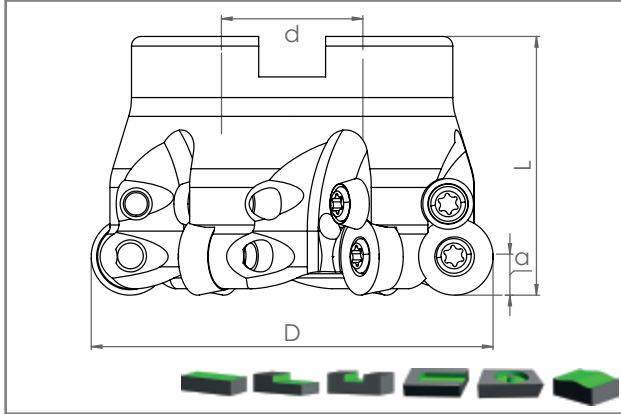

KOD CODE	ÖLÇÜLER DIMENSION (mm)					KESİCİ UÇ INSERT	YEDEK PARÇALAR SPARE PARTS	
	D	Z	d	L	a		Sıkma Vidası Clamp Screw	Anahtar Torx Key
<b>TK90 VCGT 1606 / 2205.. ISO</b>								
TK90 VC16 D40 A16 Z03-H	40	3	16	40	11	VCGT 1606.. ISO UCA UYGUNDUR FOR ISO INSERT	SSV M3.5x10 9511	T15
TK90 VC16 D50 A22 Z04-H	50	4	22	40	11			
TK90 VC16 D63 A22 Z05-H	63	5	22	40	11			
TK90 VC16 D80 A27 Z05-H	80	5	27	50	11			
TK90 VC22 D50 A22 Z04-H	50	4	22	40	14			
TK90 VC22 D63 A22 Z05-H	63	5	22	40	14	VCGT 2205.. ISO UCA UYGUNDUR FOR ISO INSERT	SSV M5x13 9519	T20
TK90 VC22 D80 A27 Z05-H	80	5	27	50	14			

H-İÇTEN SU VERMELİ  
H-WITH COOLANT HOLE

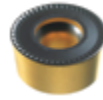
## YÜZEY FREZELER Face Milling Cutter



KOD CODE	ÖLÇÜLER DIMENSION (mm)					KESİCİ UÇ INSERT	YEDEK PARÇALAR SPARE PARTS			
	D	Z	d	L	a		Sıkma Vidası Screw	Baskı Kepi Clamp	Kep Vidası Clamp Screw	Anahtar Torx Key
<b>TK RDMT 1003 / 12T3.. RDMT 10T3 / 1204 / 1604 ISO</b>										
TK RD1003 D40 A16 Z04-H	40	4	16	40	5	RD..1003.. ISO UCA UYGUNDUR FOR ISO INSERT	SSV M3.5x10 9511	RTDP 9124	SSV M3.5x11 9526	T15
TK RD1003 D50 A22 Z05-H	50	5	22	40	5					
<b>TK RD1003 D52 A22 Z05-H</b>	52	5	22	40	5					
TK RD1003 D63 A22 Z06-H	63	6	22	40	5					
<b>TK RD1003 D66 A27 Z06-H</b>	66	6	27	50	5					
TK RD1003 D80 A27 Z07-H	80	7	27	50	5					
TK RD1003 D100 A32 Z08-H	100	8	32	50	5					
TK RD1003 D125 B40 Z09	125	9	40	63	5					
TK RD10T3 D40 A16 Z04-H	40	4	16	40	5	RD..10T3.. ISO UCA UYGUNDUR FOR ISO INSERT	SSV M3.5x10 9511	RTDP 9124	SSV M3.5x11 9526	T15
TK RD10T3 D50 A22 Z05-H	50	5	22	40	5					
TK RD10T3 D63 A22 Z06-H	63	6	22	40	5					
TK RD12T3 D40 A16 Z04-H	40	4	16	40	6	RD..12T3.. ISO UCA UYGUNDUR FOR ISO INSERT	SSV M3.5x10 9511	RTDP 9124	SSV M3.5x11 9526	T15
TK RD12T3 D50 A22 Z05-H	50	5	22	40	6					
<b>TK RD12T3 D52 A22 Z05-H</b>	52	5	22	40	6					
TK RD12T3 D63 A22 Z06-H	63	6	22	40	6					
<b>TK RD12T3 D66 A27 Z06-H</b>	66	6	27	50	6					
TK RD12T3 D80 A27 Z07-H	80	7	27	50	6					
TK RD12T3 D100 A32 Z08-H	100	8	32	50	6					
TK RD12T3 D125 B40 Z09	125	9	40	63	6					
TK RD1204 D40 A16 Z04-H	40	4	16	40	6	RD..1204.. ISO UCA UYGUNDUR FOR ISO INSERT	SSV M3.5x10 9511	RTDP 9124	SSV M3.5x11 9526	T15
TK RD1204 D50 A22 Z05-H	50	5	22	40	6					
TK RD1204 D63 A22 Z06-H	63	6	22	40	6					
TK RD1204 D80 A27 Z07-H	80	7	27	50	6					
TK RD1204 D100 A32 Z08-H	100	8	32	50	6					
TK RD1604 D63 A22 Z05-H	63	5	22	40	8	RD..1604.. ISO UCA UYGUNDUR FOR ISO INSERT	SSV M4.5x11 9518	RTDP 9124	SSV M3.5x11 9526	T20
TK RD1604 D80 A27 Z06-H	80	6	27	50	8					
TK RD1604 D100 A32 Z07-H	100	7	32	50	8					

H-İÇTEN SU VERMELİ  
H-WITH COOLANT HOLE

## KOPYA FREZELER

### Copy Face Milling Cutter

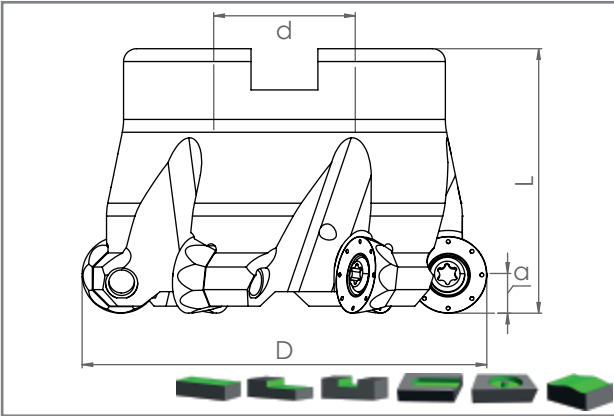

KOD CODE	ÖLÇÜLER DIMENSION (mm)					KESİCİ UÇ INSERT	YEDEK PARÇALAR SPARE PARTS	
	D	Z	d	L	a		Sıkma Vidası Clamp Screw	Anahtar Torx Key
<b>TK RPMT 10T3 / 1204..</b>								
TK RP10T3 D40 A16 Z04-H	40	4	16	40	5	RPMT 10T3.. MTSBSH UCA UYGUNDUR FOR MTSBSH INSERT	SSV M3.5x10 9511	T15
TK RP10T3 D50 A22 Z05-H	50	5	22	40	5			
TK RP10T3 D52 A22 Z05-H	52	5	22	40	5			
TK RP10T3 D63 A22 Z06-H	63	6	22	40	5			
TK RP10T3 D66 A27 Z06-H	66	6	27	50	5			
TK RP10T3 D80 A27 Z07-H	80	7	27	50	5			
TK RP10T3 D100 A32 Z08-H	100	8	32	50	5			
TK RP1204 D40 A16 Z04-H	40	4	16	40	6	RPMT 1204.. MTSBSH UCA UYGUNDUR FOR MTSBSH INSERT	SSV M4x10 9514	T15
TK RP1204 D50 A22 Z05-H	50	5	22	40	6			
TK RP1204 D52 A22 Z05-H	52	5	22	40	6			
TK RP1204 D63 A22 Z06-H	63	6	22	40	6			
TK RP1204 D66 A27 Z06-H	66	6	27	50	6			
TK RP1204 D80 A27 Z07-H	80	7	27	50	6			
TK RP1204 D100 A32 Z08-H	100	8	32	50	5			

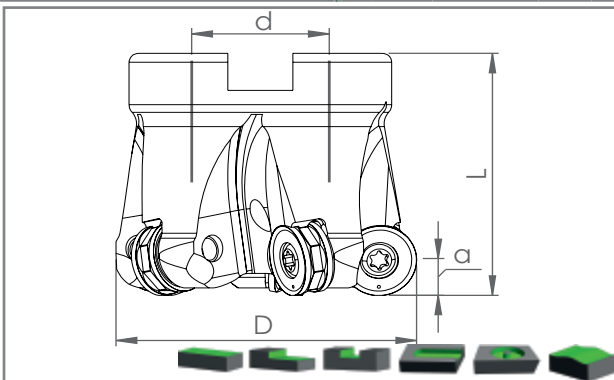

KOD CODE	ÖLÇÜLER DIMENSION (mm)					KESİCİ UÇ INSERT	YEDEK PARÇALAR SPARE PARTS	
	D	Z	d	L	a		Sıkma Vidası Clamp Screw	Anahtar Torx Key
<b>TK RNMU 1004.. / 1205.. / 1606..</b>								
TK RN10 D40 A16 Z05-H	40	5	16	40	5	RNMU 1004.. TGTC UCA UYGUNDUR FOR TGTC INSERT	SSV M3.5x10 9511	T15
TK RN10 D50 A22 Z06-H	50	6	22	40	5			
TK RN12 D40 A16 Z04-H	40	4	16	40	6	RNMU 1205.. TGTC UCA UYGUNDUR FOR TGTC INSERT	SSV M4x10 9514	T15
TK RN12 D50 A22 Z05-H	50	5	22	40	6			
TK RN12 D63 A22 Z06-H	63	6	22	40	6			
TK RN16 D50 A22 Z04-H	50	4	22	40	8	RNMU 1606.. TGTC UCA UYGUNDUR FOR TGTC INSERT	SSV M5x13 9519	T20
TK RN16 D63 A22 Z05-H	63	5	22	40	8			
TK RN16 D80 A27 Z06-H	80	6	27	50	8			

\*YEDEK PARÇA SİPARİŞ KODLARI  
\*SPARE PARTS ORDERING CODES

## KOPYA FREZELER

### Copy Face Milling Cutter

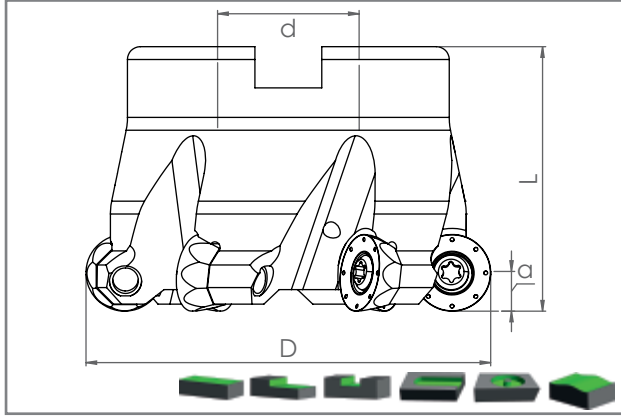

KOD CODE	ÖLÇÜLER DIMENSION (mm)					KESİCİ UÇ INSERT	YEDEK PARÇALAR SPARE PARTS	
	D	Z	d	L	a		Sıkma Vidası Clamp Screw	Anahtar Torx Key
<b>TK QPMT 10T3 / 1204..</b>								
TK QP10T3 D40 A16 Z04-H	40	4	16	40	5	QPMT 10T3.. SMTM UCA UYGUNDUR FOR SMTM INSERT	SSV M3.5x10 9511	T15
TK QP10T3 D50 A22 Z05-H	50	5	22	40	5			
TK QP10T3 D63 A22 Z06-H	63	6	22	40	5			
TK QP10T3 D80 A27 Z07-H	80	7	27	50	5			
TK QP1204 D63 A22 Z06-H	63	6	22	40	6	QPMT 1204.. SMTM UCA UYGUNDUR FOR SMTM INSERT	SSV M4x10 9514	T15
TK QP1204 D80 A27 Z07-H	80	7	27	50	6			
TK QP1204 D100 A32 Z09-H	100	9	32	50	6			

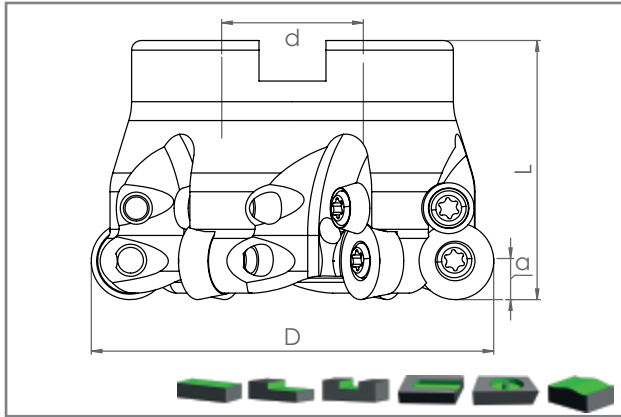



KOD CODE	ÖLÇÜLER DIMENSION (mm)					KESİCİ UÇ INSERT	YEDEK PARÇALAR SPARE PARTS			
	D	Z	d	L	a		Sıkma Vidası Screw	Baskı Kepi Clamp	Kep Vidası Clamp Screw	Anahtar Torx Key
<b>TK RCKT 10T3 / 1204..</b>										
TK RC10 D40 A16 Z04-H	40	4	16	40	5	RCKT 10T3.. ZCC-CT UCA UYGUNDUR FOR ZCC-CT INSERT	SSV M3.5x10 9511	RTDP 9124	SSV M3.5x11 9526	T15
TK RC10 D50 A22 Z05-H	50	5	22	40	5					
TK RC10 D63 A22 Z06-H	63	6	22	40	5					
TK RC12 D50 A22 Z05-H	50	5	22	40	6	RCKT 1204.. ZCC-CT UCA UYGUNDUR FOR ZCC-CT INSERT	SSV M3.5x10 9511	RTDP 9124	SSV M3.5x11 9526	T15
TK RC12 D63 A22 Z06-H	63	6	22	40	6					
TK RC12 D80 A27 Z07-H	80	7	27	50	6					

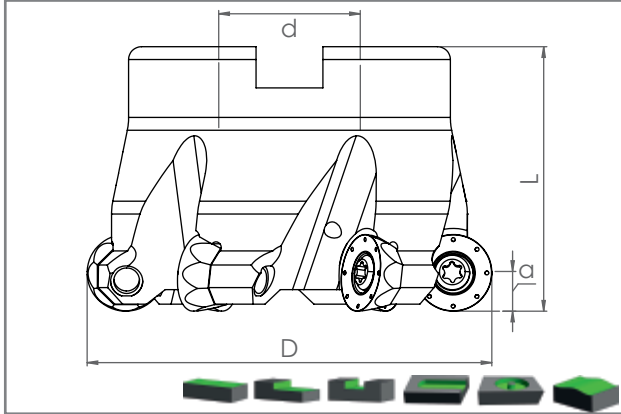

H-İÇTEN SU VERMELİ  
H-WITH COOLANT HOLE

## KOPYA FREZELER Copy Face Milling Cutter

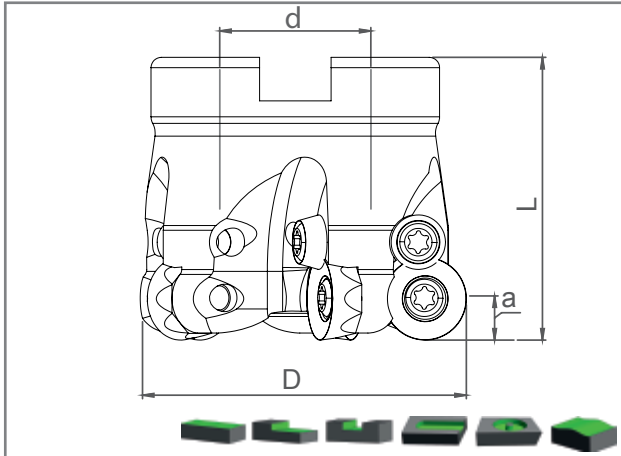

KOD CODE	ÖLÇÜLER DIMENSION (mm)					KESİCİ UÇ INSERT	YEDEK PARÇALAR SPARE PARTS	
	D	Z	d	L	a		Sıkma Vidası Clamp Screw	Anahtar Torx Key
<b>TK RP.X 10T3 / 1204..</b>								
TK RP10 D40 A16 Z04-H	40	4	16	40	5	<b>RP.X 10T3.. CRTZT UCA UYGUNDUR FOR CRTZT INSERT</b>	<b>SSV M3X8 9508</b>	<b>T08</b>
TK RP10 D50 A22 Z05-H	50	5	22	40	5			
TK RP10 D63 A22 Z06-H	63	6	22	40	5			
TK RP10 D80 A27 Z07-H	80	7	27	50	5			
TK RP12 D50 A22 Z05-H	50	5	22	40	6	<b>RP.X 1204.. CRTZT UCA UYGUNDUR FOR CRTZT INSERT</b>	<b>SSV M3.5x10 9511</b>	<b>T15</b>
TK RP12 D63 A22 Z06-H	63	6	22	40	6			
TK RP12 D80 A27 Z07-H	80	7	27	50	6			
TK RP12 D100 A32 Z08-H	100	8	32	50	6			





KOD CODE	ÖLÇÜLER DIMENSION (mm)					KESİCİ UÇ INSERT	YEDEK PARÇALAR SPARE PARTS			
	D	Z	d	L	a		Sıkma Vidası Screw	Baskı Kepi Clamp	Kep Vidası Clamp Screw	Anahtar Torx Key
<b>TK RCKT 1204..</b>										
TK RC1204S D50 A22 Z05-H	50	5	22	40	6	<b>RCKT 1204.. SDVK UCA UYGUNDUR FOR SDVK INSERT</b>	<b>SSV M3.5x10 9511</b>	<b>RTDP 9124</b>	<b>SSV M3.5x11 9526</b>	<b>T15</b>
TK RC1204S D63 A22 Z06-H	63	6	22	40	6					
TK RC1204S D80 A27 Z07-H	80	7	27	50	6					

## KOPYA FREZELER

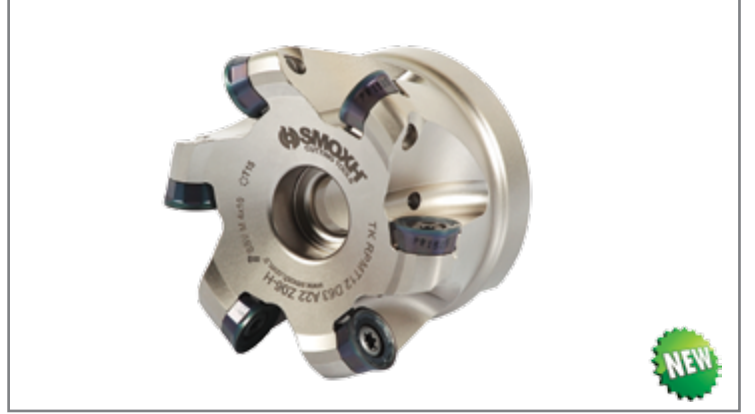
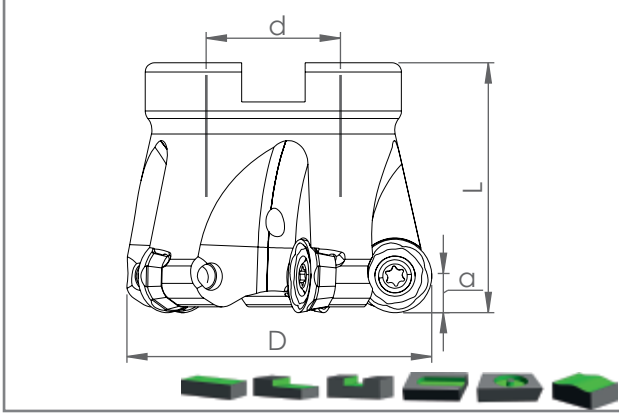
### Copy Face Milling Cutter



KOD CODE	ÖLÇÜLER DIMENSION (mm)					KESİCİ UÇ INSERT	YEDEK PARÇALAR SPARE PARTS	
	D	Z	d	L	a		Sıkma Vidası Clamp Screw	Anahtar Torx Key
<b>TK RPMT / RPGT 10T3 / 1204..</b>								
TK RPMT10 D40 A16 Z04-H	40	4	16	40	5	RPMT / RPGT 10T3.. KYCR UCA UYGUNDUR FOR KYCR INSERT	SSV M3X8 9508	T08
TK RPMT10 D50 A22 Z05-H	50	5	22	40	5			
TK RPMT10 D63 A22 Z06-H	63	6	22	40	5			
TK RPMT12 D40 A16 Z04-H	40	4	16	40	6	RPMT / RPGT 1204.. KYCR UCA UYGUNDUR FOR KYCR INSERT	SSV M4x10 9514	T15
TK RPMT12 D50 A22 Z05-H	50	5	22	40	6			
TK RPMT12 D52 A22 Z05-H	52	5	22	40	6			
TK RPMT12 D63 A22 Z06-H	63	6	22	40	6			
TK RPMT12 D80 A27 Z07-H	80	7	27	50	6			

**Teknoloji profesyonellikle birleŖti**  
Technology combined with professionalism

[www.smoxh.com.tr](http://www.smoxh.com.tr)

## **HIZLI İLERLEMELİ YÜZEY FREZELER**

High Feed Face Milling Cutter





## HIZLI İLERLEMELİ YÜZEY FREZELER

### High Feed Face Milling Cutter

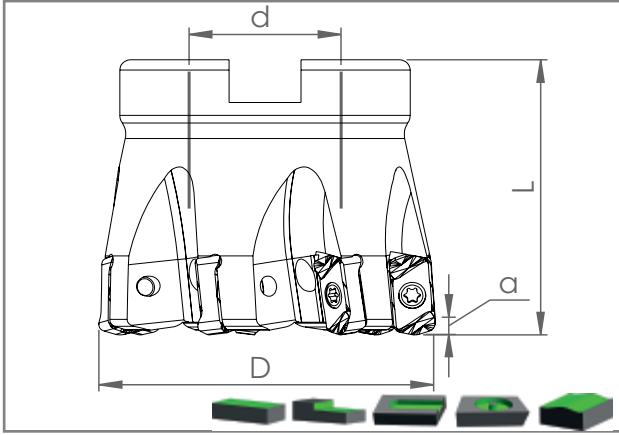

KOD CODE	ÖLÇÜLER DIMENSION (mm)					KESİCİ UÇ INSERT	YEDEK PARÇALAR SPARE PARTS	
	D	Z	d	L	a		Sıkma Vidası Clamp Screw	Anahtar Allen Key
<b>HTK LNMU 0303..</b>								
HTK LN03 D40 A16 Z05-H	40	5	16	40	1	LNMU 0303.. TNGLY UCA UYGUNDUR FOR TNGLY INSERT	SSV M2.5x7 9506	T08
HTK LN03 D50 A22 Z07-H	50	7	22	40	1			

KOD CODE	ÖLÇÜLER DIMENSION (mm)					KESİCİ UÇ INSERT	YEDEK PARÇALAR SPARE PARTS	
	D	Z	d	L	a		Sıkma Vidası Clamp Screw	Anahtar Allen Key
<b>HTK LNMU 06X5..</b>								
HTK LN06 D50 A22 Z04-H	50	4	22	40	1.5	LNMU 06X5.. TNGLY UCA UYGUNDUR FOR TNGLY INSERT	SSV M5x13 9519	T20
HTK LN06 D63 A22 Z05-H	63	5	22	40	1.5			

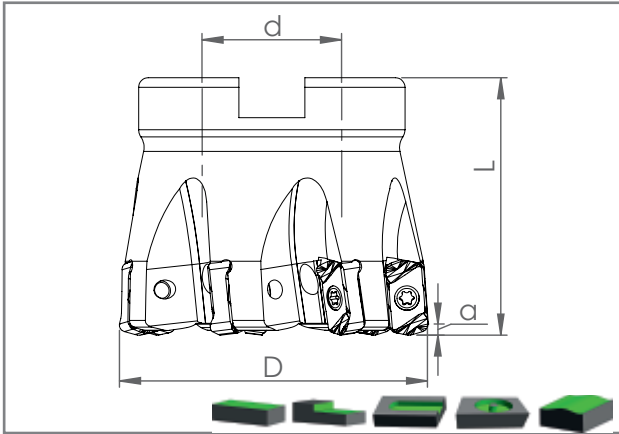



KOD CODE	ÖLÇÜLER DIMENSION (mm)					KESİCİ UÇ INSERT	YEDEK PARÇALAR SPARE PARTS	
	D	Z	d	L	a		Sıkma Vidası Clamp Screw	Anahtar Allen Key
<b>HTK ENMU 1004..</b>								
HTK EN10 D40 A16 Z05-H	40	5	16	40	1.7	ENMU 1004.. DJT UCA UYGUNDUR FOR DJT INSERT	SSV M2.5x7 9506	T08
HTK EN10 D50 A22 Z07-H	50	7	22	40	1.7			
HTK EN10 D63 A22 Z09-H	63	9	22	40	1.7			

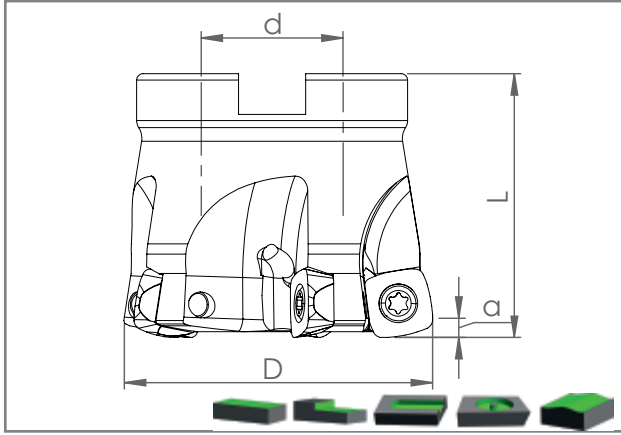

H-ÇİTEN SU VERMELİ  
H-WITH COOLANT HOLE

## HIZLI İLERLEMELİ YÜZEY FREZELER High Feed Face Milling Cutter



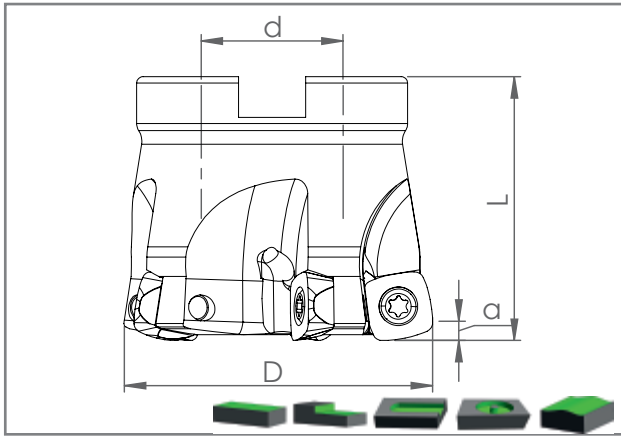



KOD CODE	ÖLÇÜLER DIMENSION (mm)					KESİCİ UÇ INSERT	YEDEK PARÇALAR SPARE PARTS	
	D	Z	d	L	a		Sıkma Vidası Clamp Screw	Anahtar Allen Key
<b>HTK SPNW / SPET / SPMT 1004..</b>								
HTK SP10 D40 A16 Z04-H	40	4	16	40	1.6	SPNW / SPET / SPMT 1004.. DJT UCA UYGUNDUR FOR DJT INSERT	SSV M3.5x10 9511	T15
HTK SP10 D50 A22 Z05-H	50	5	22	40	1.6			
HTK SP10 D63 A22 Z06-H	63	6	22	40	1.6			



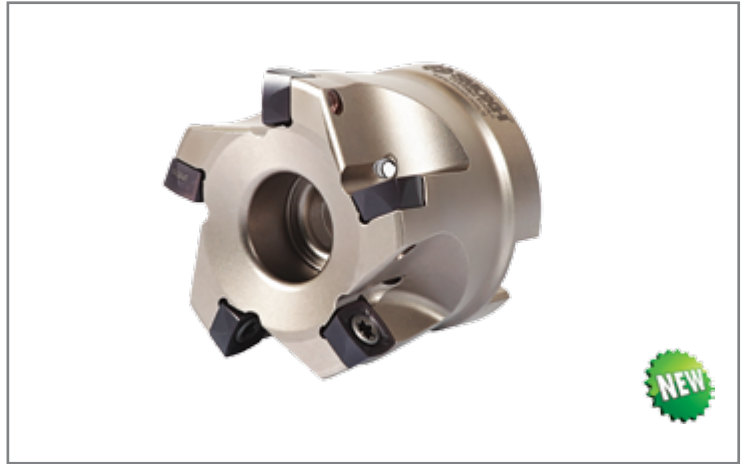
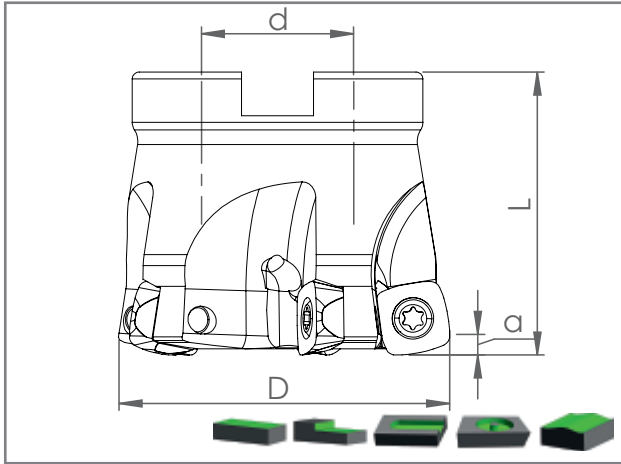



KOD CODE	ÖLÇÜLER DIMENSION (mm)					KESİCİ UÇ INSERT	YEDEK PARÇALAR SPARE PARTS	
	D	Z	d	L	a		Sıkma Vidası Clamp Screw	Anahtar Allen Key
<b>HTK SPEW 2006..</b>								
HTK SP20 D50 A22 Z05-H	50	5	22	40	2.45	SPEW 2006.. DJT UCA UYGUNDUR FOR DJT INSERT	SSV M6x16 9520	T20
HTK SP20 D63 A22 Z06-H	63	6	22	40	2.45			

## HIZLI İLERLEMELİ YÜZEY FREZELER High Feed Face Milling Cutter

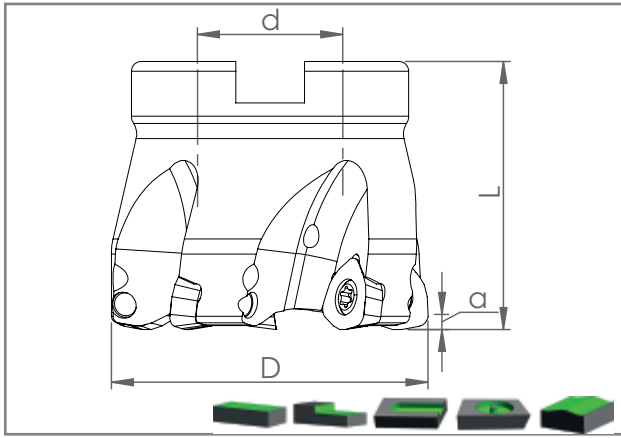

KOD CODE	ÖLÇÜLER DIMENSION (mm)					KESİCİ UÇ INSERT	YEDEK PARÇALAR SPARE PARTS	
	D	Z	d	L	a		Sıkma Vidası Clamp Screw	Anahtar Allen Key
<b>HTK SPNW 1405..</b>								
HTK SP14 D50 A22 Z04-H	50	4	22	40	2.05	<b>SPNW 1405.. DJT UCA UYGUNDUR FOR DJT INSERT</b>	<b>SSV M5x13 9519</b>	<b>T20</b>
HTK SP14 D63 A22 Z05-H	63	5	22	40	2.05			





KOD CODE	ÖLÇÜLER DIMENSION (mm)					KESİCİ UÇ INSERT	YEDEK PARÇALAR SPARE PARTS	
	D	Z	d	L	a		Sıkma Vidası Clamp Screw	Anahtar Allen Key
<b>HTK WDMW 06T3 / 0805 / 10X6..</b>								
HTK WDMW06 D40 A16 Z04-H	40	4	16	40	1.5	<b>WDMW 06T3.. DJT UCA UYGUNDUR FOR DJT INSERT</b>	<b>SSV M3.5x8 SC 9513</b>	<b>T10</b>
HTK WDMW06 D50 A22 Z05-H	50	5	22	40	1.5			
HTK WDMW08 D50 A22 Z04-H	50	4	22	40	2	<b>WDMW 0805.. DJT UCA UYGUNDUR FOR DJT INSERT</b>	<b>SSV M4.5x11 9518</b>	<b>T20</b>
HTK WDMW08 D63 A22 Z05-H	63	5	22	40	2			
HTK WDMW10 D125 B40 Z06	125	6	40	63	2.5	<b>WDMW 10X6.. DJT UCA UYGUNDUR FOR DJT INSERT</b>	<b>SSV M5x13 9519</b>	<b>T20</b>
HTK WDMW10 D160 C40 Z07	160	7	40	63	2.5			

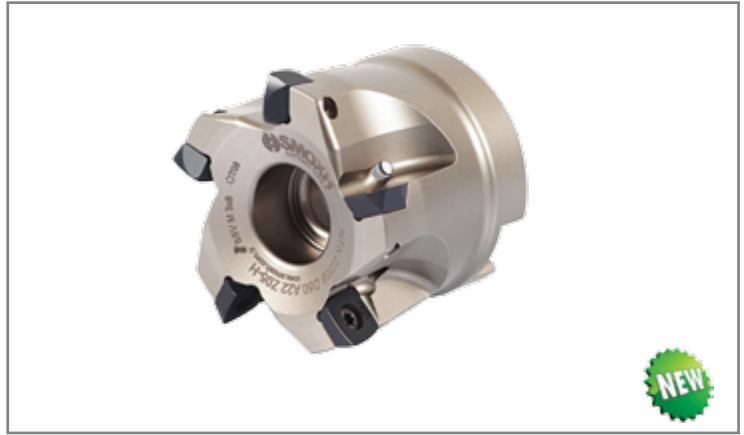
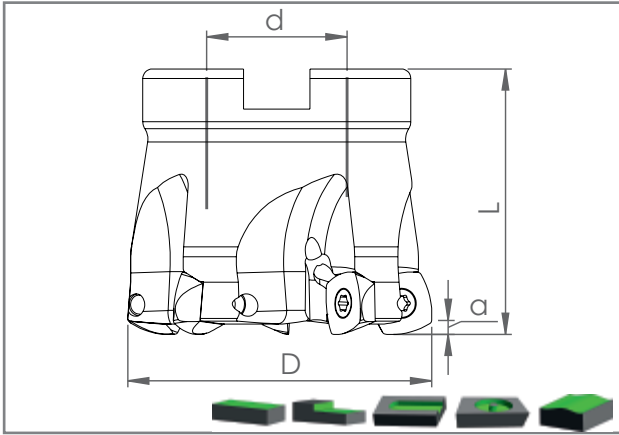

H-İÇTEN SU VERMELİ  
H-WITH COOLANT HOLE

## HIZLI İLERLEMELİ YÜZEY FREZELER High Feed Face Milling Cutter

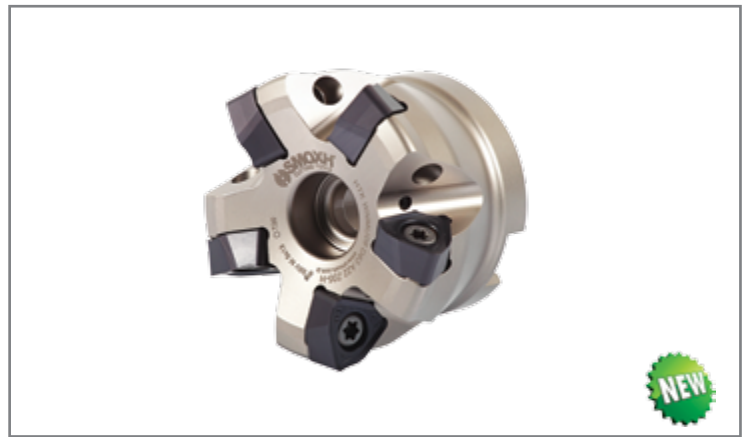
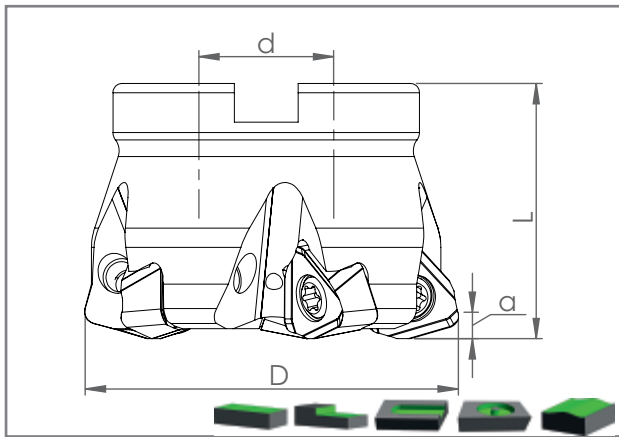

KOD CODE	ÖLÇÜLER DIMENSION (mm)					KESİCİ UÇ INSERT	YEDEK PARÇALAR SPARE PARTS	
	D	Z	d	L	a		Sıkma Vidası Clamp Screw	Anahtar Allen Key
<b>HTK ZDCW / ZDEW 0907 / 1204..</b>								
HTK ZD09 D40 A16 Z04-H	40	4	16	40	1.3	<b>ZDCW 09T3.. PRMT UCA UYGUNDUR FOR PRMT INSERT</b>	SSV M3x8 <b>9508</b>	T08
HTK ZD09 D50 A22 Z05-H	50	5	22	40	1.3			
HTK ZD12 D50 A22 Z04-H	50	4	22	40	1.6	<b>ZDEW 1204.. PRMT UCA UYGUNDUR FOR PRMT INSERT</b>	SSV M4x10 <b>9514</b>	T15
HTK ZD12 D63 A22 Z05-H	63	5	22	40	1.6			





KOD CODE	ÖLÇÜLER DIMENSION (mm)					KESİCİ UÇ INSERT	YEDEK PARÇALAR SPARE PARTS	
	D	Z	d	L	a		Sıkma Vidası Clamp Screw	Anahtar Allen Key
<b>HTK WNMU 0907..</b>								
HTK WNMU09 D63 A22 Z05-H	63	5	22	40	2.25	<b>WNMU 0907.. DJT UCA UYGUNDUR FOR DJT INSERT</b>	SSV M5x13 <b>9519</b>	T20
HTK WNMU09 D66 A27 Z06-H	66	6	27	40	2.25			

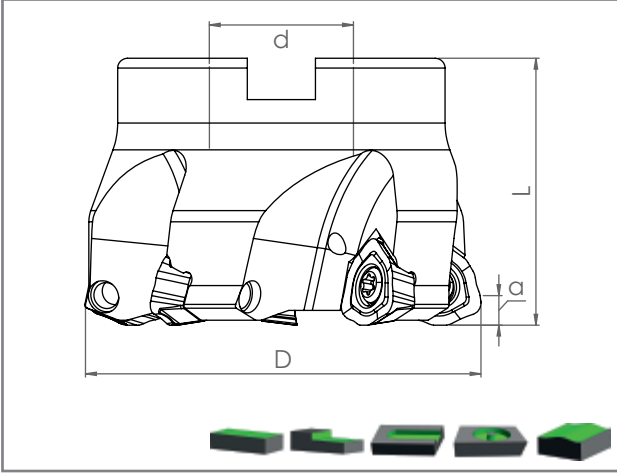

## HIZLI İLERLEMELİ YÜZEY FREZELER

### High Feed Face Milling Cutter

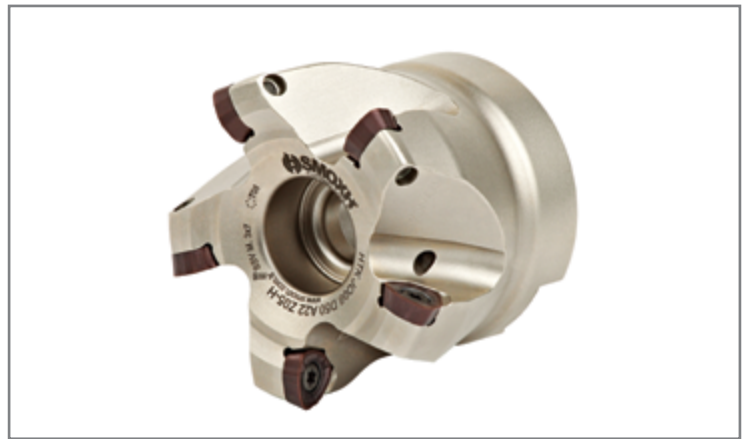
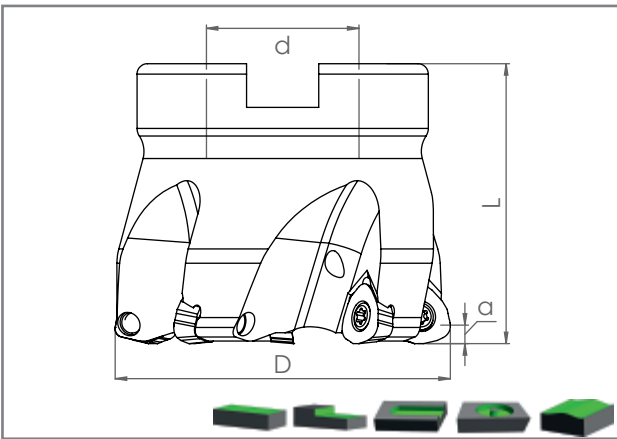

KOD CODE	ÖLÇÜLER DIMENSION (mm)					KESİCİ UÇ INSERT	YEDEK PARÇALAR SPARE PARTS	
	D	Z	d	L	a		Sıkma Vidası Clamp Screw	Anahtar Allen Key
<b>HTK WDMT 0804 / 1204..</b>								
HTK WD08 D40 A16 Z04-H	40	4	16	40	1.5	WDMT 0804.. SMTM UCA UYGUNDUR FOR SMTM INSERT	SSV M3x8 9508	T08
HTK WD08 D50 A22 Z05-H	50	5	22	40	1.5			
HTK WD12 D50 A22 Z04-H	50	4	22	40	2	WDMT 1204.. SMTM UCA UYGUNDUR FOR SMTM INSERT	SSV M4x10 9514	T15
HTK WD12 D63 A22 Z05-H	63	5	22	40	2			





KOD CODE	ÖLÇÜLER DIMENSION (mm)					KESİCİ UÇ INSERT	YEDEK PARÇALAR SPARE PARTS	
	D	Z	d	L	a		Sıkma Vidası Clamp Screw	Anahtar Allen Key
<b>HTK JOM. 0803..</b>								
HTK JO08 D40 A16 Z04-H	40	4	16	40	1.5	JOM. 0803.. MTSBSH UCA UYGUNDUR FOR MTSBSH INSERT	SSV M3x8 9508	T08
HTK JO08 D50 A22 Z05-H	50	5	22	40	1.5			

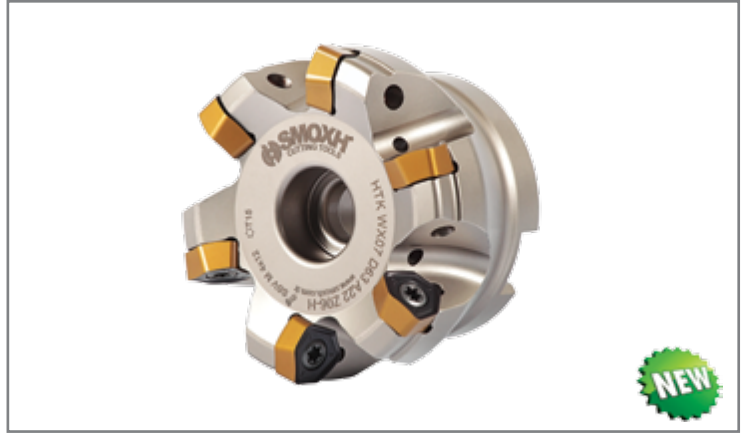
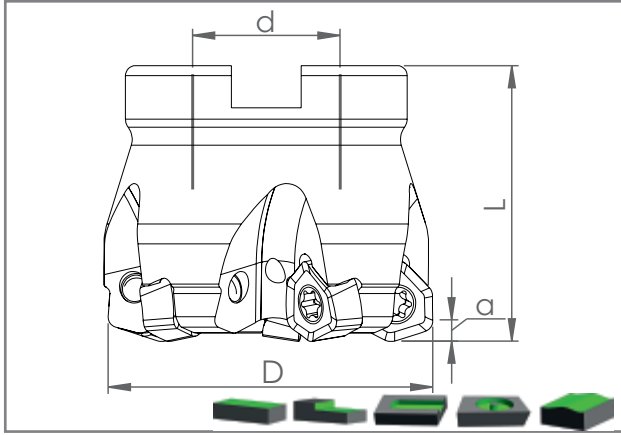

H-İÇTEN SU VERMELİ  
H-WITH COOLANT HOLE

## HIZLI İLERLEMELİ YÜZEY FREZELER High Feed Face Milling Cutter

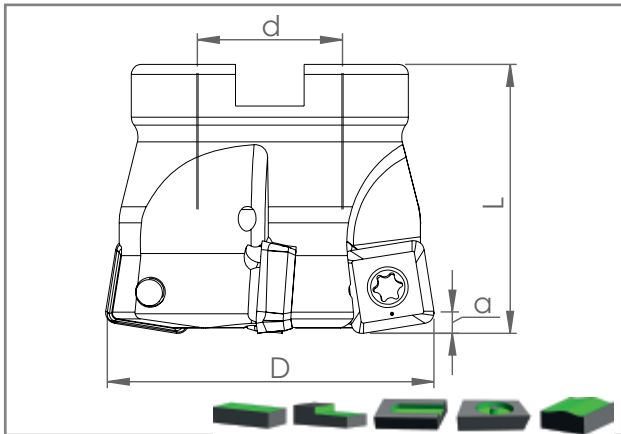

KOD CODE	ÖLÇÜLER DIMENSION (mm)					KESİCİ UÇ INSERT	YEDEK PARÇALAR SPARE PARTS	
	D	Z	d	L	a		Sıkma Vidası Clamp Screw	Anahtar Allen Key
<b>HTK WXCU 0705..</b>								
HTK WX07 D40 A16 Z04-H	40	4	16	40	1.5	<b>WXCU 0705.. ISCR UCA UYGUNDUR FOR ISCR INSERT</b>	<b>SSV M4x12 9515</b>	<b>T15</b>
HTK WX07 D50 A22 Z05-H	50	5	22	40	1.5			
HTK WX07 D63 A22 Z06-H	63	6	22	40	1.5			



KOD CODE	ÖLÇÜLER DIMENSION (mm)					KESİCİ UÇ INSERT	YEDEK PARÇALAR SPARE PARTS	
	D	Z	d	L	a		Sıkma Vidası Clamp Screw	Anahtar Allen Key
<b>HTK SOMT 1205..</b>								
HTK SOMT12 D50 A22 Z04-H	50	4	22	40	1.5	<b>SOMT 1205.. ISCR UCA UYGUNDUR FOR ISCR INSERT</b>	<b>SSV M4x12 9515</b>	<b>T15</b>
HTK SOMT12 D63 A22 Z05-H	63	5	22	40	1.5			

## HIZLI İLERLEMELİ YÜZEY FREZELER

### High Feed Face Milling Cutter

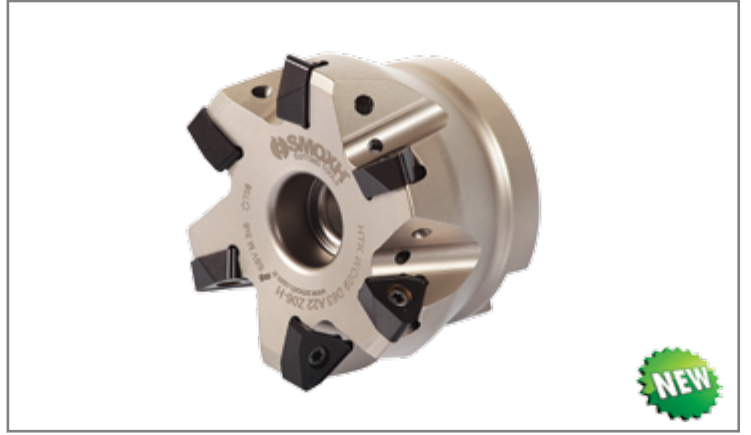
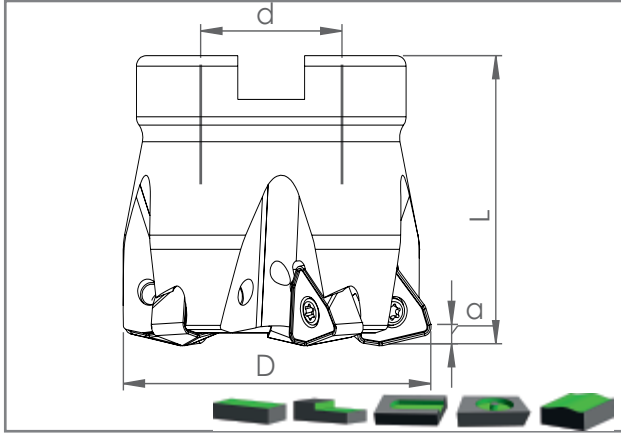

KOD CODE	ÖLÇÜLER DIMENSION (mm)					KESİCİ UÇ INSERT	YEDEK PARÇALAR SPARE PARTS	
	D	Z	d	L	a		Sıkma Vidası Clamp Screw	Anahtar Allen Key
<b>HTK WOEJ 0905..</b>								
HTK WO09 D40 A16 Z04-H	40	4	16	40	1.6	<b>WOEJ 0905.. KNMTL UCA UYGUNDUR FOR KNMTL INSERT</b>	<b>SSV M3x8 9508</b>	<b>T08</b>
HTK WO09 D50 A22 Z05-H	50	5	22	40	1.6			
HTK WO09 D63 A22 Z06-H	63	6	22	40	1.6			

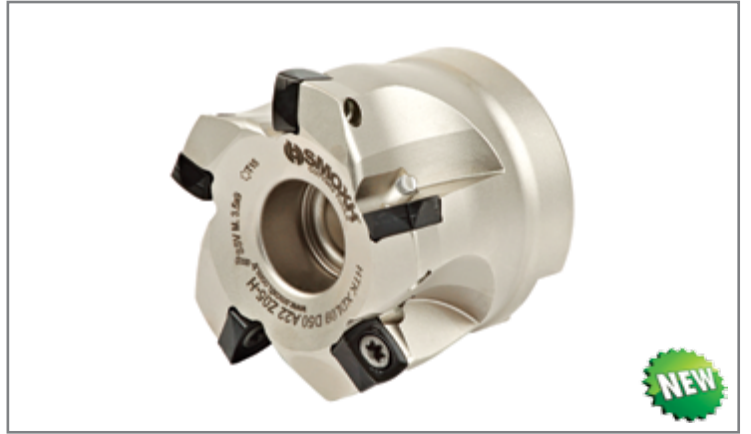
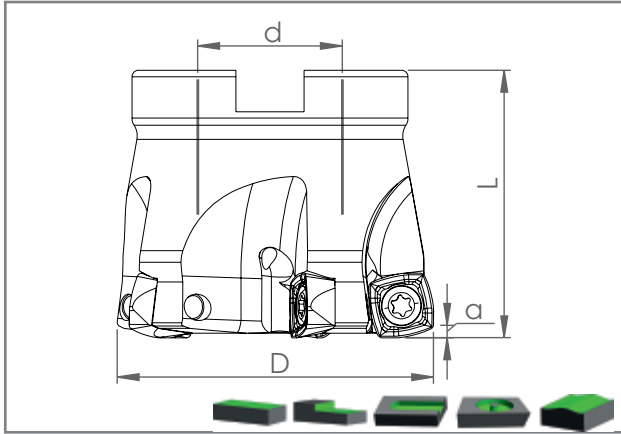

KOD CODE	ÖLÇÜLER DIMENSION (mm)					KESİCİ UÇ INSERT	YEDEK PARÇALAR SPARE PARTS	
	D	Z	d	L	a		Sıkma Vidası Clamp Screw	Anahtar Allen Key
<b>HTK XDLT 0904..</b>								
HTK XDLT09 D40 A16 Z04-H	40	4	16	40	1.45	<b>XDLT 0904.. KNMTL UCA UYGUNDUR FOR KNMTL INSERT</b>	<b>SSV M3.5x10 9511</b>	<b>T15</b>
HTK XDLT09 D50 A22 Z05-H	50	5	22	40	1.45			
HTK XDLT09 D63 A22 Z06-H	63	6	22	40	1.45			

## HIZLI İLERLEMELİ YÜZEY FREZELER

### High Feed Face Milling Cutter

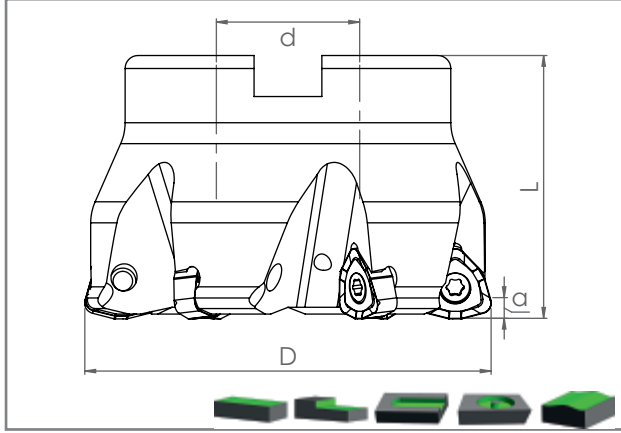

KOD CODE	ÖLÇÜLER DIMENSION (mm)					KESİCİ UÇ INSERT	YEDEK PARÇALAR SPARE PARTS	
	D	Z	d	L	a		Sıkma Vidası Clamp Screw	Anahtar Allen Key
<b>HTK WNMX 09T3..</b>								
HTK WN09T3 D40 A16 Z04-H	40	4	16	40	1.5	<b>WNMX 09T3.. KRLY UCA UYGUNDUR FOR KRLY INSERT</b>	<b>SSV M3x8 9508</b>	<b>T08</b>
HTK WN09T3 D50 A22 Z05-H	50	5	22	40	1.5			
<b>HTK WN09T3 D52 A22 Z05-H</b>	52	5	22	40	1.5			
HTK WN09T3 D63 A22 Z06-H	63	6	22	40	1.5			
<b>HTK WN09T3 D66 A27 Z06-H</b>	66	6	27	50	1.5			

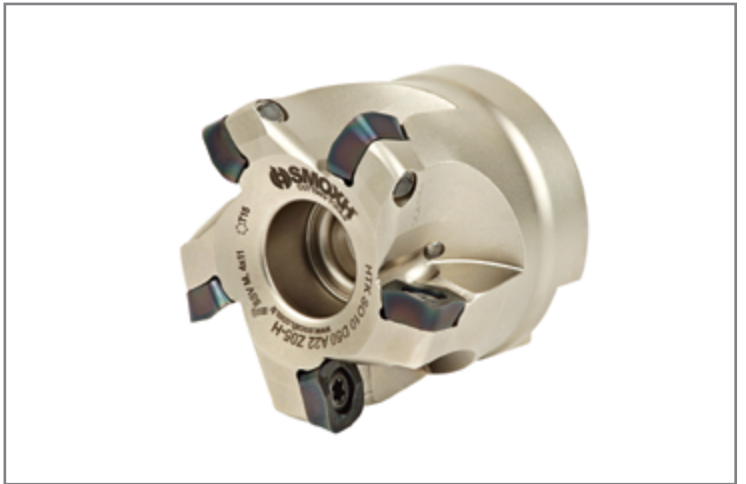
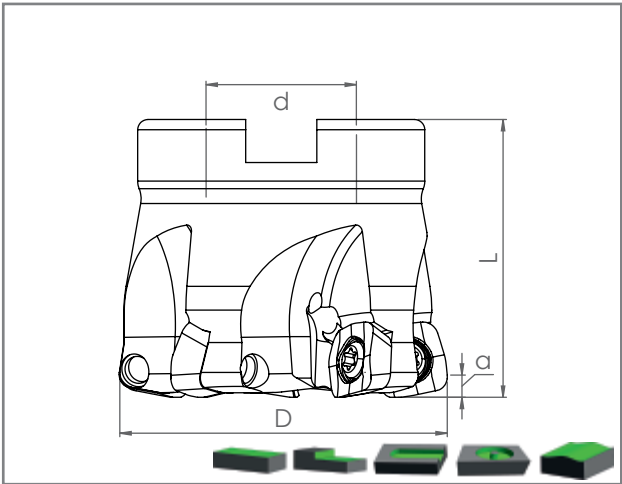





KOD CODE	ÖLÇÜLER DIMENSION (mm)					KESİCİ UÇ INSERT	YEDEK PARÇALAR SPARE PARTS	
	D	Z	d	L	a		Sıkma Vidası Clamp Screw	Anahtar Allen Key
<b>HTK SOMT 1004 / 1405..</b>								
HTK SO10 D40 A16 Z04-H	40	4	16	40	1.2	<b>SOMT 1004.. KYCR UCA UYGUNDUR FOR KYCR INSERT</b>	<b>SSV M4x10 9514</b>	<b>T15</b>
HTK SO10 D50 A22 Z05-H	50	5	22	40	1.2			
HTK SO10 D63 A22 Z06-H	63	6	22	40	1.2			
HTK SO14 D63 A22 Z05-H	63	5	22	40	2.7	<b>SOMT 1405.. KYCR UCA UYGUNDUR FOR KYCR INSERT</b>	<b>SSV M5x13 9519</b>	<b>T20</b>
HTK SO14 D66 A27 Z05-H	66	5	27	50	2.7			
HTK SO14 D80 A27 Z06-H	80	6	27	50	2.7			



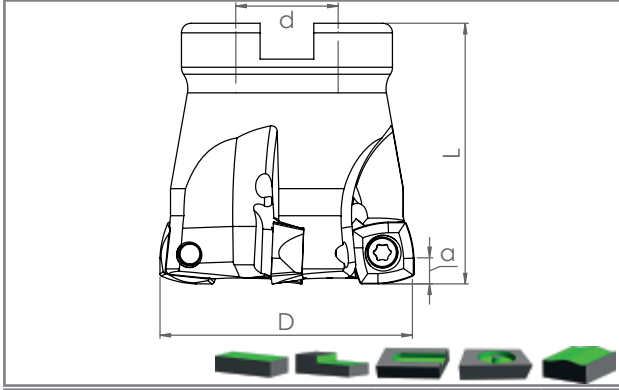

## HIZLI İLERLEMELİ YÜZEY FREZELER



### High Feed Face Milling Cutter

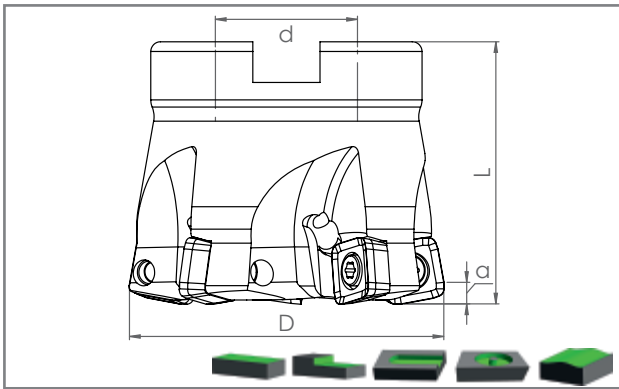

KOD CODE	ÖLÇÜLER DIMENSION (mm)					KESİCİ UÇ INSERT	YEDEK PARÇALAR SPARE PARTS	
	D	Z	d	L	a		Sıkma Vidası Clamp Screw	Anahtar Allen Key
<b>HTK SDMT 09T3 / 1204..</b>								
HTK SDMT09 D40 A16 Z04-H	40	4	16	40	1.4	SDMT 09T3.. ZCC-CT UCA UYGUNDUR FOR ZCC-CT INSERT	SSV M3.5x8 SC 9513	T10
HTK SDMT09 D50 A22 Z05-H	50	5	22	40	1.4			
HTK SDMT09 D63 A22 Z06-H	63	6	22	40	1.4			
HTK SDMT12 D50 A22 Z04-H	50	4	22	40	1.8	SDMT 1204.. ZCC-CT UCA UYGUNDUR FOR ZCC-CT INSERT	SSV M4x10 9514	T15
HTK SDMT12 D63 A22 Z05-H	63	5	22	40	1.8			

KOD CODE	ÖLÇÜLER DIMENSION (mm)					KESİCİ UÇ INSERT	YEDEK PARÇALAR SPARE PARTS	
	D	Z	d	L	a		Sıkma Vidası Clamp Screw	Anahtar Allen Key
<b>HTK SDKX 0904 / 1205..</b>								
HTK SDKX09 D40 A16 Z04-H	40	4	16	40	1.4	SDKX 0904.. LAMINA UCA UYGUNDUR FOR LAMINA INSERT	SSV M3.5x8 SC 9513	T10
HTK SDKX09 D50 A22 Z05-H	50	5	22	40	1.4			
HTK SDKX09 D63 A22 Z06-H	63	6	22	40	1.4			
HTK SDKX12 D50 A22 Z04-H	50	4	22	40	1.8	SDKX 1205.. LAMINA UCA UYGUNDUR FOR LAMINA INSERT	SSV M3.5x10 9511	T15
HTK SDKX12 D63 A22 Z05-H	63	5	22	40	1.8			





KOD CODE	ÖLÇÜLER DIMENSION (mm)					KESİCİ UÇ INSERT	YEDEK PARÇALAR SPARE PARTS	
	D	Z	d	L	a		Sıkma Vidası Clamp Screw	Anahtar Allen Key
<b>HTK R210.09..</b>								
HTK R210.09 D40 A16 Z04-H	40	4	16	40	1.2	R210.09.. SDVK UCA UYGUNDUR FOR SDVK INSERT	SSV M3.5x10 9511	T15
HTK R210.09 D50 A22 Z05-H	50	5	22	40	1.2			
HTK R210.09 D63 A22 Z06-H	63	6	22	40	1.2			

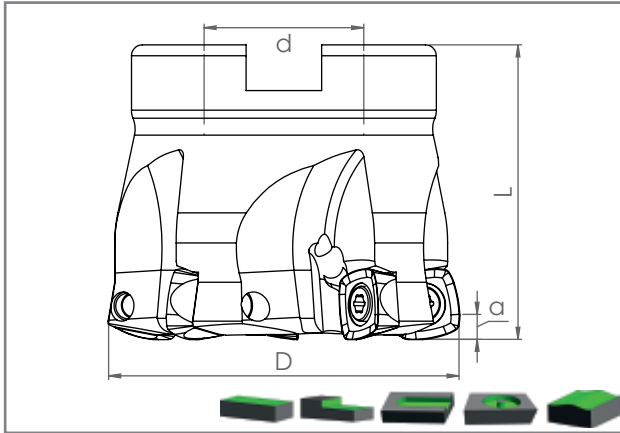

H-İÇTEN SU VERMELİ  
H-WITH COOLANT HOLE

## HIZLI İLERLEMELİ YÜZEY FREZELER High Feed Face Milling Cutter



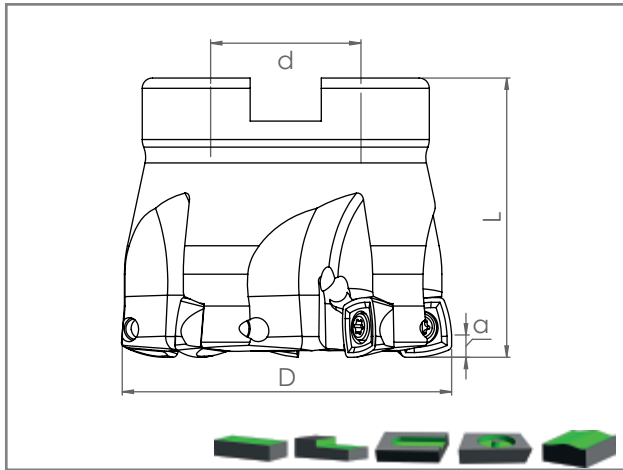



KOD CODE	ÖLÇÜLER DIMENSION (mm)					KESİCİ UÇ INSERT	YEDEK PARÇALAR SPARE PARTS	
<b>HTK XDLX 09T3..</b>	<b>D</b>	<b>Z</b>	<b>d</b>	<b>L</b>	<b>a</b>		Sıkma Vidası Clamp Screw	Anahtar Allen Key
								
	HTK XD09 D40 A16 Z04-H	40	4	16	40	1.2	<b>SSV M3.5x10 9511</b>	<b>T15</b>
	HTK XD09 D50 A22 Z05-H	50	5	22	40	1.2		
HTK XD09 D63 A22 Z06-H	63	6	22	40	1.2			



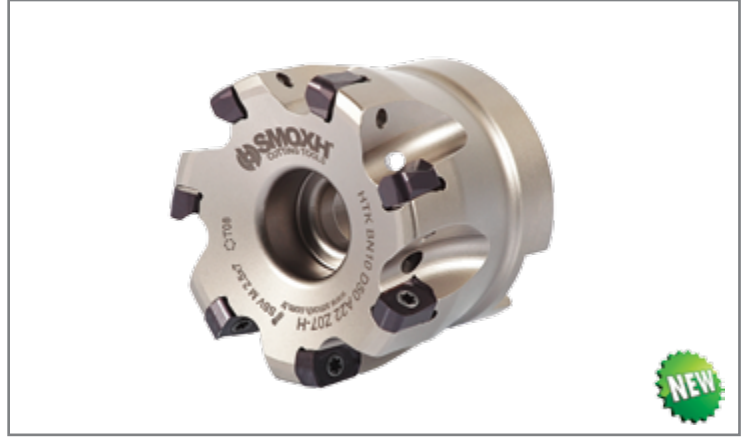
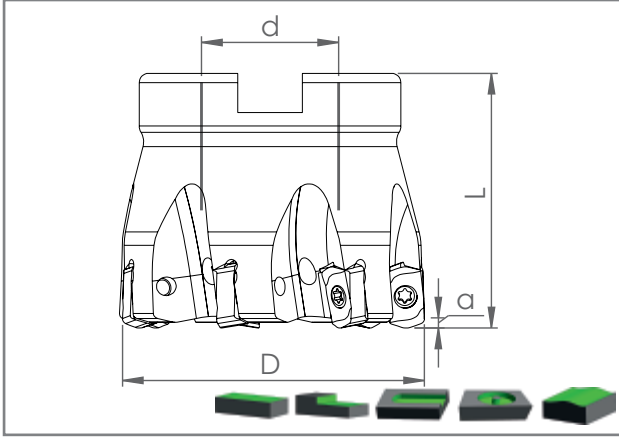



KOD CODE	ÖLÇÜLER DIMENSION (mm)					KESİCİ UÇ INSERT	YEDEK PARÇALAR SPARE PARTS	
<b>HTK SPKT 08T3..</b>	<b>D</b>	<b>Z</b>	<b>d</b>	<b>L</b>	<b>a</b>		Sıkma Vidası Clamp Screw	Anahtar Allen Key
								
	HTK SPKT08 D40 A16 Z04-H	40	4	16	40	1.5	<b>SSV M3x8 9508</b>	<b>T08</b>
	HTK SPKT08 D50 A22 Z05-H	50	5	22	40	1.5		
HTK SPKT08 D63 A22 Z06-H	63	6	22	40	1.5			

## HIZLI İLERLEMELİ YÜZEY FREZELER High Feed Face Milling Cutter

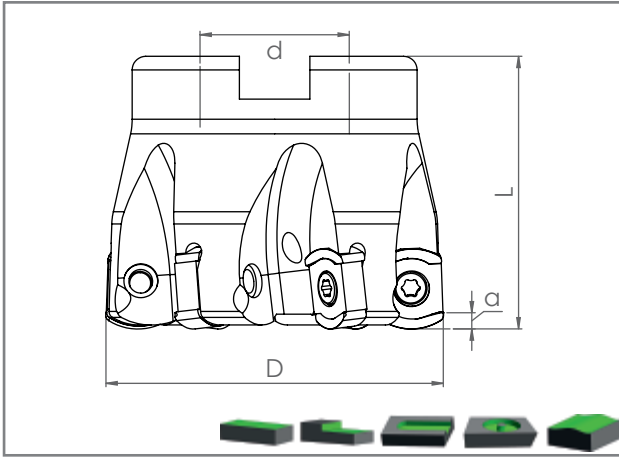





KOD CODE	ÖLÇÜLER DIMENSION (mm)					KESİCİ UÇ INSERT	YEDEK PARÇALAR SPARE PARTS	
	D	Z	d	L	a		Sıkma Vidası Clamp Screw	Anahtar Allen Key
<b>HTK BNGX 10T3..</b>								
HTK BN10 D40 A16 Z06-H	40	6	16	40	1	<b>BNGX 10T3.. PRMT UCA UYGUNDUR FOR PRMT INSERT</b>	<b>SSV M2.5x7 9506</b>	<b>T08</b>
HTK BN10 D50 A22 Z07-H	50	7	22	40	1			



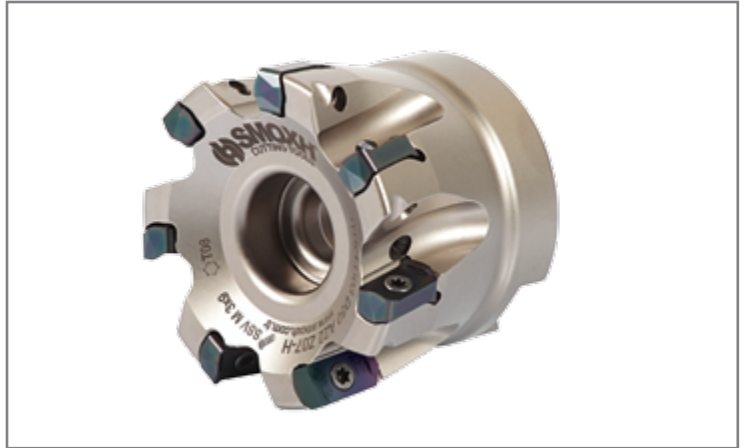
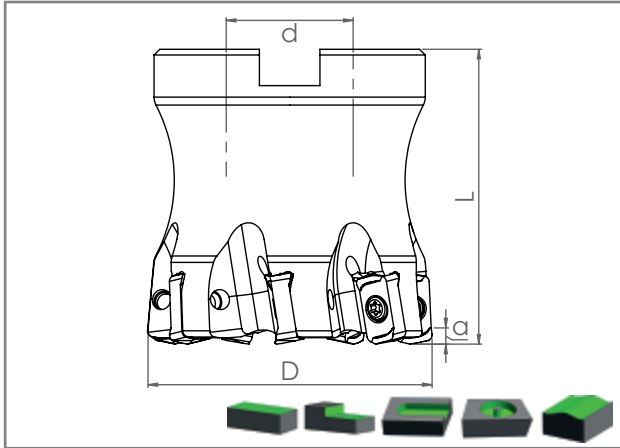



KOD CODE	ÖLÇÜLER DIMENSION (mm)					KESİCİ UÇ INSERT	YEDEK PARÇALAR SPARE PARTS	
	D	Z	d	L	a		Sıkma Vidası Clamp Screw	Anahtar Allen Key
<b>HTK BLMP 0603 / 0904..</b>								
HTK BL06 D40 A16 Z06-H	40	6	16	40	1	<b>BLMP 0603.. TGTC UCA UYGUNDUR FOR TGTC INSERT</b>	<b>SSV M2.5x7 9506</b>	<b>T08</b>
HTK BL06 D50 A22 Z07-H	50	7	22	40	1			
HTK BL09 D40 A16 Z05-H	40	5	16	40	2	<b>BLMP 0904.. TGTC UCA UYGUNDUR FOR TGTC INSERT</b>	<b>SSV M3.5x10 9511</b>	<b>T15</b>
HTK BL09 D50 A22 Z06-H	50	6	22	40	2			
HTK BL09 D63 A22 Z07-H	63	7	22	40	2			

## HIZLI İLERLEMELİ YÜZEY FREZELER High Feed Face Milling Cutter

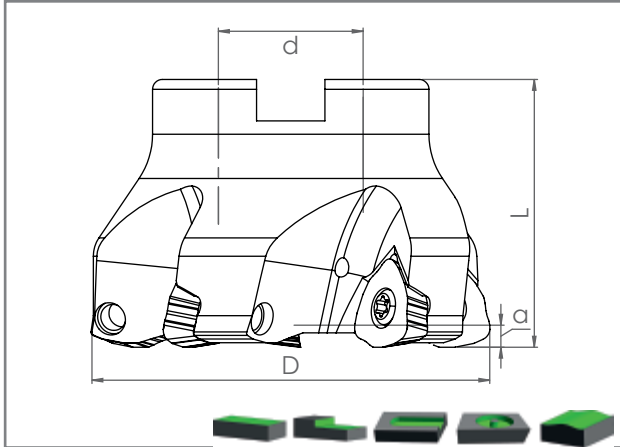

KOD CODE	ÖLÇÜLER DIMENSION (mm)					KESİCİ UÇ INSERT	YEDEK PARÇALAR SPARE PARTS	
	D	Z	d	L	a		Sıkma Vidası Clamp Screw	Anahtar Allen Key
<b>HTK LOGU 0303..</b>								
HTK LG03 D40 A16 Z05-H	40	5	16	40	1	<b>LOGU 0303.. KYCR UCA UYGUNDUR FOR KYCR INSERT</b>	<b>SSV M3x6 LG 9509</b>	<b>T08</b>
HTK LG03 D50 A22 Z07-H	50	7	22	40	1			
HTK LG03 D63 A22 Z09-H	63	9	22	40	1			





KOD CODE	ÖLÇÜLER DIMENSION (mm)					KESİCİ UÇ INSERT	YEDEK PARÇALAR SPARE PARTS	
	D	Z	d	L	a		Sıkma Vidası Clamp Screw	Anahtar Allen Key
<b>HTK JDM.. 09T3 / 1204..</b>								
HTK JD09 D40 A16 Z04-H	40	4	16	40	1.5	<b>JDM. 09T3.. MITSUBIHSI UCA UYGUNDUR FOR MITSBSH INSERT</b>	<b>SSV M3.5x10 9511</b>	<b>T15</b>
HTK JD09 D50 A22 Z05-H	50	5	22	40	1.5			
HTK JD12 D50 A22 Z04-H	50	4	22	40	2	<b>JDM. 1204.. MITSUBIHSI UCA UYGUNDUR FOR MITSBSH INSERT</b>	<b>SSV M4x10 9514</b>	
HTK JD12 D63 A22 Z05-H	63	5	22	40	2			

## HIZLI İLERLEMELİ YÜZEY FREZELER

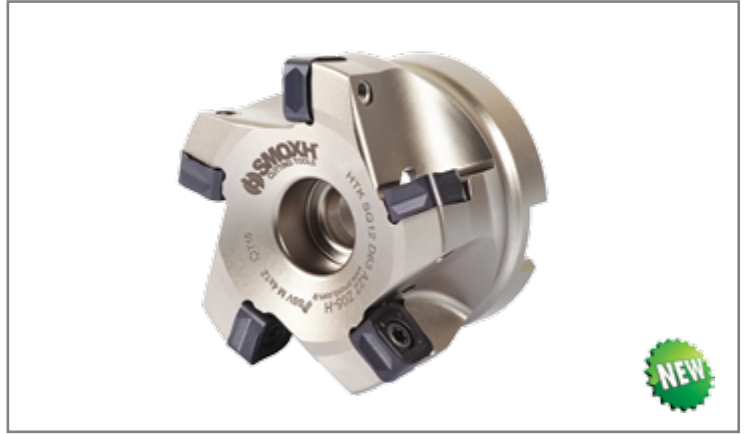
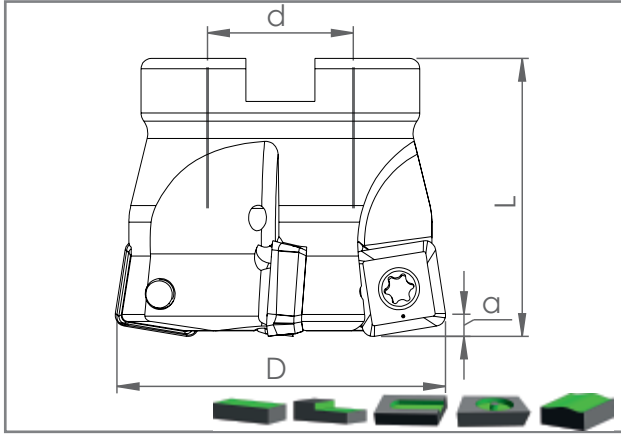
### High Feed Face Milling Cutter



KOD CODE	ÖLÇÜLER DIMENSION (mm)					KESİCİ UÇ INSERT	YEDEK PARÇALAR SPARE PARTS	
HTK SQMU 1206..	D	Z	d	L	a		Sıkma Vidası Clamp Screw	Anahtar Allen Key
								
							SSV M4x12 9515	T15
HTK SQ12 D50 A22 Z04-H	50	4	22	40	2	<b>SQMU 1206..</b> <b>TNGLY</b> <b>UCA UYGUNDUR</b> <b>FOR TNGLY INSERT</b>		
HTK SQ12 D63 A22 Z05-H	63	5	22	40	2			



**Teknoloji profesyonellikle birleŖti**  
Technology combined with professionalism

[www.smoxh.com.tr](http://www.smoxh.com.tr)

## DEĐIŐKEN UÇLU MATKAPLAR



Indexable Drills

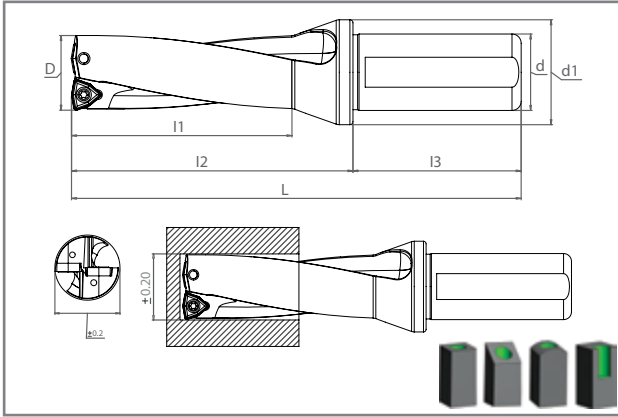

## DEĞİŞKEN UÇLU MATKAPLAR

### Indexable Drills



KOD CODE	ÖLÇÜLER DIMENSION (mm)							KESİCİ UÇ INSERT	YEDEK PARÇALAR SPARE PARTS	
	D	d	d1	L	l1	l2	l3		Sıkma Vidası Clamp Screw	Anahtar Torx Key
<b>SDUM WCM. D2 U-DRILL</b>										
SDUM 16xD2 WCM.030208	16	25	34	108	32	52	56	<b>WCM. 030208 ISO UCA UYGUNDUR FOR ISO INSERT</b>	<b>SSV M2.5x6 9505</b>	<b>T08</b>
SDUM 16.5xD2 WCM.030208	16.5	25	34	110	33	54	56			
SDUM 17xD2 WCM.030208	17	25	34	110	34	54	56			
SDUM 17.5xD2 WCM.030208	17.5	25	34	113	35	57	56			
SDUM 18xD2 WCM.030208	18	25	34	113	36	57	56			
SDUM 18.5xD2 WCM.030208	18.5	25	34	115	37	59	56			
SDUM 19xD2 WCM.030208	19	25	34	115	38	59	56			
SDUM 19.5xD2 WCM.030208	19.5	25	34	119	39	63	56			
SDUM 20xD2 WCM.040208	20	25	34	119	40	63	56	<b>WCM. 040208 ISO UCA UYGUNDUR FOR ISO INSERT</b>	<b>SSV M2.5x6 9505</b>	<b>T08</b>
SDUM 20.5xD2 WCM.040208	20.5	25	34	121	41	65	56			
SDUM 21xD2 WCM.040208	21	25	34	121	42	65	56			
SDUM 21.5xD2 WCM.040208	21.5	25	34	123	43	67	56			
SDUM 22xD2 WCM.040208	22	25	34	123	44	67	56			
SDUM 22.5xD2 WCM.040208	22.5	25	34	127	45	71	56			
SDUM 23xD2 WCM.040208	23	25	34	127	46	71	56			
SDUM 23.5xD2 WCM.040208	23.5	25	34	130	47	74	56			
SDUM 24xD2 WCM.050308	24	25	44	130	48	74	56	<b>WCM. 050308 ISO UCA UYGUNDUR FOR ISO INSERT</b>	<b>SSV M3x8 9508</b>	<b>T08</b>
SDUM 24.5xD2 WCM.050308	24.5	25	44	133	49	77	56			
SDUM 25xD2 WCM.050308	25	25	44	133	50	77	56			
SDUM 25.5xD2 WCM.050308	25.5	25	44	135	51	79	56			
SDUM 26xD2 WCM.050308	26	25	44	135	52	79	56			
SDUM 26.5xD2 WCM.050308	26.5	25	44	137	53	81	56			
SDUM 27xD2 WCM.050308	27	25	44	137	54	81	56			
SDUM 27.5xD2 WCM.050308	27.5	25	44	140	55	84	56			
SDUM 28xD2 WCM.050308	28	25	44	140	56	84	56			
SDUM 28.5xD2 WCM.050308	28.5	25	44	142	57	86	56			
SDUM 29xD2 WCM.050308	29	25	44	142	58	86	56			
SDUM 29.5xD2 WCM.050308	29.5	25	44	151	59	91	56			

## DEĞİŞKEN UÇLU MATKAPLAR

### Indexable Drills

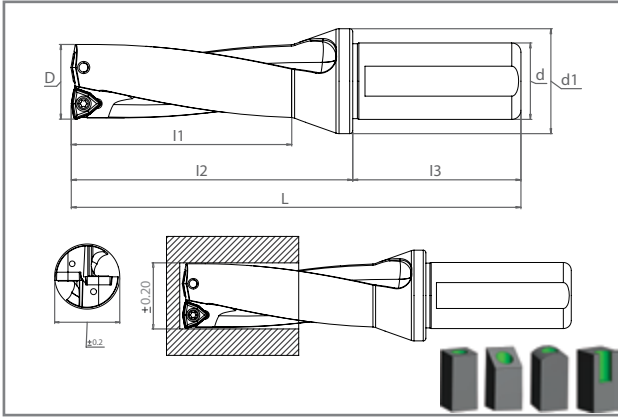





KOD CODE	ÖLÇÜLER DIMENSION (mm)							KESİCİ UÇ INSERT	YEDEK PARÇALAR SPARE PARTS	
	D	d	d1	L	I1	I2	I3		Sıkma Vidası Clamp Screw	Anahtar Torx Key
<b>SDUM WCM. D2 U-DRILL</b>										
SDUM 30XD2 WCM.06T308	30	32	44	141	60	81	60	<b>WCM. 06T308 ISO UCA UYGUNDUR FOR ISO INSERT</b>	<b>SSV M3.5x10 9511</b>	<b>T15</b>
SDUM 31XD2 WCM.06T308	31	32	44	144	62	83	60			
SDUM 32XD2 WCM.06T308	32	32	44	146	64	86	60			
SDUM 33XD2 WCM.06T308	33	32	44	149	66	88	60			
SDUM 34XD2 WCM.06T308	34	32	44	151	68	91	60			
SDUM 35XD2 WCM.06T308	35	32	44	154	70	93	60			
SDUM 36XD2 WCM.06T308	36	32	44	157	72	96	60			
SDUM 37XD2 WCM.06T308	37	32	44	160	74	100	60			
SDUM 38XD2 WCM.06T308	38	32	44	163	76	103	60			
SDUM 39XD2 WCM.06T308	39	32	44	165	78	105	60			
SDUM 40XD2 WCM.06T308	40	32	44	168	80	108	60			
SDUM 41XD2 WCM.06T308	41	32	44	171	82	110	60			
SDUM 42XD2 WCM.06T308	42	32	44	173	84	112	60			
SDUM 43XD2 WCM.06T308	43	32	44	176	86	114	60			
SDUM 44XD2 WCM.06T308	44	32	44	178	88	117	60			
SDUM 45XD2 WCM.080412	45	40	60	192	90	123	70	<b>WCM. 080412 ISO UCA UYGUNDUR FOR ISO INSERT</b>	<b>SSV M4x10 9514</b>	
SDUM 46XD2 WCM.080412	46	40	60	195	92	125	70			
SDUM 47XD2 WCM.080412	47	40	60	197	94	127	70			
SDUM 48XD2 WCM.080412	48	40	60	200	96	130	70			
SDUM 49XD2 WCM.080412	49	40	60	202	98	132	70			
SDUM 50XD2 WCM.080412	50	40	60	205	100	135	70			
SDUM 51XD2 WCM.080412	51	40	60	207	102	137	70			
SDUM 52XD2 WCM.080412	52	40	60	210	104	140	70			
SDUM 53XD2 WCM.080412	53	40	60	212	106	142	70			
SDUM 54XD2 WCM.080412	54	40	60	215	108	145	70			
SDUM 55XD2 WCM.080412	55	40	60	217	110	147	70			
SDUM 56XD2 WCM.080412	56	40	60	220	112	150	70			
SDUM 57XD2 WCM.080412	57	40	60	222	114	152	70			
SDUM 58XD2 WCM.080412	58	40	60	225	116	155	70			
SDUM 59XD2 WCM.080412	59	40	60	227	118	157	70			
SDUM 60XD2 WCM.080412	60	40	60	230	120	160	70			

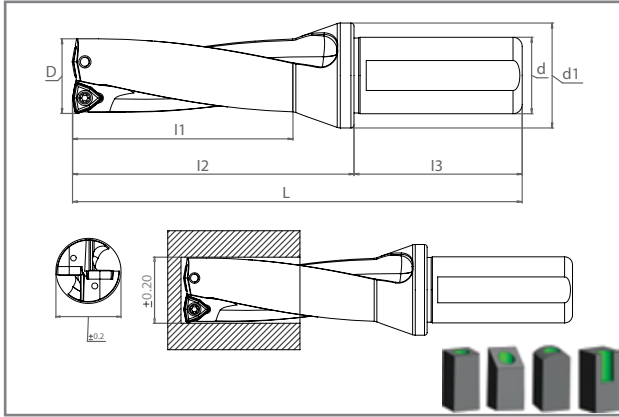

## DEĞİŞKEN UÇLU MATKAPLAR

### Indexable Drills



KOD CODE	ÖLÇÜLER DIMENSION (mm)							KESİCİ UÇ INSERT	YEDEK PARÇALAR SPARE PARTS	
	D	d	d1	L	l1	l2	l3		Sıkma Vidası Clamp Screw	Anahtar Torx Key
<b>SDUM WCM. D3 U-DRILL</b>										
SDUM 16XD3 WCM.030208	16	25	34	124	48	68	56	<b>WCM. 030208 ISO UCA UYGUNDUR FOR ISO INSERT</b>	<b>SSV M2.5x6 9505</b>	T08
SDUM 16.5XD3 WCM.030208	16.5	25	34	127	49.5	71	56			
SDUM 17XD3 WCM.030208	17	25	34	127	51	71	56			
SDUM 17.5XD3 WCM.030208	17.5	25	34	131	52.5	75	56			
SDUM 18XD3 WCM.030208	18	25	34	131	54	75	56			
SDUM 18.5XD3 WCM.030208	18.5	25	34	134	55.5	78	56			
SDUM 19XD3 WCM.030208	19	25	34	134	57	78	56			
SDUM 19.5XD3 WCM.030208	19.5	25	34	139	58.5	83	56			
SDUM 20XD3 WCM.040208	20	25	34	139	60	83	56			
SDUM 20.5XD3 WCM.040208	20.5	25	34	142	61.5	88	56			
SDUM 21XD3 WCM.040208	21	25	34	142	63	88	56	<b>WCM. 040208 ISO UCA UYGUNDUR FOR ISO INSERT</b>	<b>SSV M3x8 9508</b>	T08
SDUM 21.5XD3 WCM.040208	21.5	25	34	145	64.5	89	56			
SDUM 22XD3 WCM.040208	22	25	34	145	66	89	56			
SDUM 22.5XD3 WCM.040208	22.5	25	34	150	67.5	94	56			
SDUM 23XD3 WCM.040208	23	25	34	150	69	94	56			
SDUM 23.5XD3 WCM.040208	23.5	25	34	154	70.5	98	56			
SDUM 24XD3 WCM.050308	24	25	34	154	72	98	56			
SDUM 24.5XD3 WCM.050308	24.5	25	34	158	73.5	102	56			
SDUM 25XD3 WCM.050308	25	25	34	158	75	102	56			
SDUM 25.5XD3 WCM.050308	25.5	25	34	161	76.5	105	56			
SDUM 26XD3 WCM.050308	26	25	34	161	78	105	56	<b>WCM. 050308 ISO UCA UYGUNDUR FOR ISO INSERT</b>	<b>SSV M3x8 9508</b>	T08
SDUM 26.5XD3 WCM.050308	26.5	25	34	164	79.5	108	56			
SDUM 27XD3 WCM.050308	27	25	34	164	81	108	56			
SDUM 27.5XD3 WCM.050308	27.5	25	34	168	82.5	112	56			
SDUM 28XD3 WCM.050308	28	25	34	168	84	112	56			
SDUM 28.5XD3 WCM.050308	28.5	25	34	171	85.5	115	56			
SDUM 29XD3 WCM.050308	29	25	34	171	87	115	56			
SDUM 29.5XD3 WCM.050308	29.5	25	34	177	88.5	111	56			

## DEĞİŞKEN UÇLU MATKAPLAR

### Indexable Drills

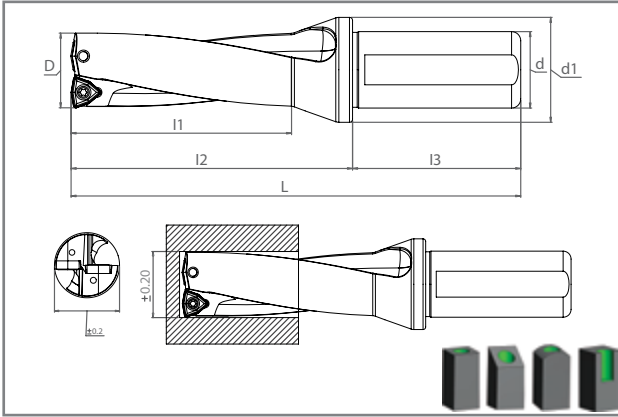

KOD CODE	ÖLÇÜLER DIMENSION (mm)							KESİCİ UÇ INSERT	YEDEK PARÇALAR SPARE PARTS	
	D	d	d1	L	I1	I2	I3		Sıkma Vidası Clamp Screw	Anahtar Torx Key
<b>SDUM WCM D3 U-DRILL</b>										
SDUM 30XD3 WCM.06T308	30	32	44	171	90	111	60	<b>WCM. 06T308 ISO UCA UYGUNDUR FOR ISO INSERT</b>	<b>SSV M3.5x10 9511</b>	T15
SDUM 31XD3 WCM.06T308	31	32	44	175	93	115	60			
SDUM 32XD3 WCM.06T308	32	32	44	178	96	118	60			
SDUM 33XD3 WCM.06T308	33	32	44	182	99	122	60			
SDUM 34XD3 WCM.06T308	34	32	44	185	102	125	60			
SDUM 35XD3 WCM.06T308	35	32	44	189	105	129	60			
SDUM 36XD3 WCM.06T308	36	32	44	193	108	133	60			
SDUM 37XD3 WCM.06T308	37	32	44	197	111	136	60			
SDUM 38XD3 WCM.06T308	38	32	44	201	114	141	60			
SDUM 39XD3 WCM.06T308	39	32	44	204	117	144	60			
SDUM 40XD3 WCM.06T308	40	32	44	208	120	148	60			
SDUM 41XD3 WCM.06T308	41	32	44	212	123	152	60			
SDUM 42XD3 WCM.06T308	42	32	44	215	126	155	60			
SDUM 43XD3 WCM.06T308	43	32	44	219	129	158	60			
SDUM 44XD3 WCM.06T308	44	32	44	222	132	162	60			
SDUM 45XD3 WCM.080412	45	40	60	237	135	167	70			
SDUM 46XD3 WCM.080412	46	40	60	241	138	171	70			
SDUM 47XD3 WCM.080412	47	40	60	244	141	174	70			
SDUM 48XD3 WCM.080412	48	40	60	248	144	178	70			
SDUM 49XD3 WCM.080412	49	40	60	251	147	181	70			
SDUM 50XD3 WCM.080412	50	40	60	255	150	185	70			
SDUM 51XD3 WCM.080412	51	40	60	258	153	188	70			
SDUM 52XD3 WCM.080412	52	40	60	261	156	191	70			
SDUM 53XD3 WCM.080412	53	40	60	264	159	194	70			
SDUM 54XD3 WCM.080412	54	40	60	267	162	197	70			
SDUM 55XD3 WCM.080412	55	40	60	270	165	200	70			
SDUM 56XD3 WCM.080412	56	40	60	273	168	203	70			
SDUM 57XD3 WCM.080412	57	40	60	276	171	206	70			
SDUM 58XD3 WCM.080412	58	40	60	279	174	209	70			
SDUM 59XD3 WCM.080412	59	40	60	282	177	211	70			
SDUM 60XD3 WCM.080412	60	40	60	285	180	214	70			

## DEĞİŞKEN UÇLU MATKAPLAR

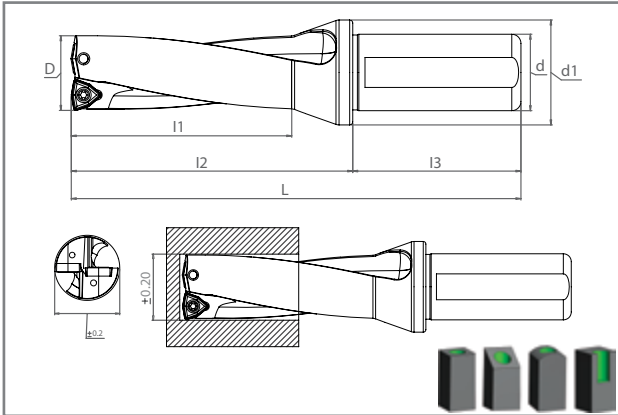

### Indexable Drills

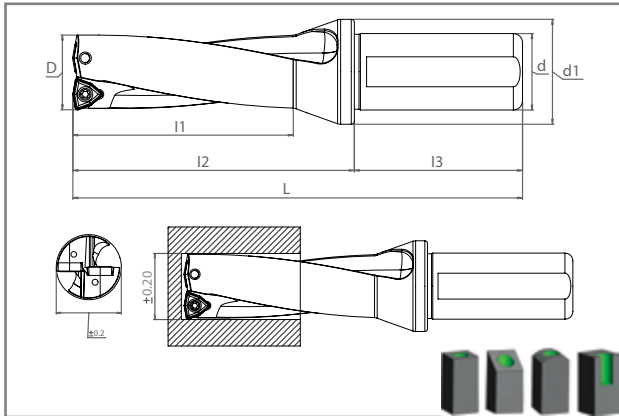

KOD CODE	ÖLÇÜLER DIMENSION (mm)							KESİCİ UÇ INSERT	YEDEK PARÇALAR SPARE PARTS	
	D	d	d1	L	I1	I2	I3		Sıkma Vidası Clamp Screw	Anahtar Torx Key
<b>SDUM WCM. D4 U-DRILL</b>										
SDUM 16XD4 WCM.030208	16	25	34	140	64	84	56	<b>WCM. 030208 ISO UCA UYGUNDUR FOR ISO INSERT</b>	<b>SSV M2.5x6 9505</b>	T08
SDUM 16.5XD4 WCM.030208	16.5	25	34	144	66	84	56			
SDUM 17XD4 WCM.030208	17	25	34	144	68	88	56			
SDUM 17.5XD4 WCM.030208	17.5	25	34	149	70	88	56			
SDUM 18XD4 WCM.030208	18	25	34	149	72	93	56			
SDUM 18.5XD4 WCM.030208	18.5	25	34	153	74	93	56			
SDUM 19XD4 WCM.030208	19	25	34	153	76	97	56			
SDUM 19.5XD4 WCM.030208	19.5	25	34	159	78	97	56			
SDUM 20XD4 WCM.040208	20	25	34	159	80	103	56			
SDUM 20.5XD4 WCM.040208	20.5	25	34	163	82	103	56			
SDUM 21XD4 WCM.040208	21	25	34	163	84	107	56	<b>WCM. 040208 ISO UCA UYGUNDUR FOR ISO INSERT</b>	T08	
SDUM 21.5XD4 WCM.040208	21.5	25	34	167	86	107	56			
SDUM 22XD4 WCM.040208	22	25	34	167	88	111	56			
SDUM 22.5XD4 WCM.040208	22.5	25	34	173	90	111	56			
SDUM 23XD4 WCM.040208	23	25	34	173	92	117	56			
SDUM 23.5XD4 WCM.040208	23.5	25	34	178	94	117	56			
SDUM 24XD4 WCM.050308	24	25	34	178	96	122	56			
SDUM 24.5XD4 WCM.050308	24.5	25	34	183	98	122	56			
SDUM 25XD4 WCM.050308	25	25	34	183	100	127	56	<b>WCM. 050308 ISO UCA UYGUNDUR FOR ISO INSERT</b>	<b>SSV M3x8 9508</b>	T08
SDUM 25.5XD4 WCM.050308	25.5	25	34	187	102	127	56			
SDUM 26XD4 WCM.050308	26	25	34	187	104	131	56			
SDUM 26.5XD4 WCM.050308	26.5	25	34	191	106	131	56			
SDUM 27XD4 WCM.050308	27	25	34	191	108	135	56			
SDUM 27.5XD4 WCM.050308	27.5	25	34	196	110	135	56			
SDUM 28XD4 WCM.050308	28	25	34	196	112	140	56			
SDUM 28.5XD4 WCM.050308	28.5	25	34	200	114	140	56			
SDUM 29XD4 WCM.050308	29	25	34	200	116	144	56			
SDUM 29.5XD4 WCM.050308	29.5	25	34	202	118	144	56			
SDUM 30XD4 WCM.06T308	30	32	44	201	120	141	60	<b>WCM. 06T308 ISO UCA UYGUNDUR FOR ISO INSERT</b>	<b>SSV M3.5x10 9511</b>	T15
SDUM 31XD4 WCM.06T308	31	32	44	206	124	145	60			
SDUM 32XD4 WCM.06T308	32	32	44	210	128	149	60			
SDUM 33XD4 WCM.06T308	33	32	44	215	132	154	60			
SDUM 33.5XD4 WCM.06T308	33.5	32	44	219	134	158	60			
SDUM 34XD4 WCM.06T308	34	32	44	219	136	158	60			
SDUM 35XD4 WCM.06T308	35	32	44	227	140	166	60			
SDUM 36XD4 WCM.06T308	36	32	44	229	144	169	60			
SDUM 37XD4 WCM.06T308	37	32	44	234	148	172	60			

## DEĞİŞKEN UÇLU MATKAPLAR Indexable Drills





KOD CODE	ÖLÇÜLER DIMENSION (mm)							KESİCİ UÇ INSERT	YEDEK PARÇALAR SPARE PARTS	
	D	d	d1	L	I1	I2	I3		Sıkma Vidası Clamp Screw	Anahtar Torx Key
<b>SDUM WCM. D4 U-DRILL</b>										
SDUM 38XD4 WCM.06T308	38	32	44	239	152	178	60	<b>WCM. 06T308 ISO UCA UYGUNDUR FOR ISO INSERT</b>	<b>SSV M3.5x10 9511</b>	T15
SDUM 38.5XD4 WCM.06T308	38.5	32	44	243	154	181	60			
SDUM 39XD4 WCM.06T308	39	32	44	243	156	181	60			
SDUM 40XD4 WCM.06T308	40	32	44	248	160	188	60			
SDUM 41XD4 WCM.06T308	41	32	44	253	164	191	60			
SDUM 42XD4 WCM.06T308	42	32	44	257	168	195	60			
SDUM 43XD4 WCM.06T308	43	32	44	262	172	197	60			
SDUM 44XD4 WCM.06T308	44	32	44	266	176	200	60			
SDUM 45XD4 WCM.080412	45	40	60	272	180	202	70			
SDUM 46XD4 WCM.080412	46	40	60	276	184	206	70			
SDUM 47XD4 WCM.080412	47	40	60	280	188	210	70	<b>WCM. 080412 ISO UCA UYGUNDUR FOR ISO INSERT</b>	<b>SSV M4x10 9514</b>	
SDUM 48XD4 WCM.080412	48	40	60	284	192	214	70			
SDUM 49XD4 WCM.080412	49	40	60	288	196	218	70			
SDUM 50XD4 WCM.080412	50	40	60	292	200	221	70			

## DEĞİŞKEN UÇLU MATKAPLAR

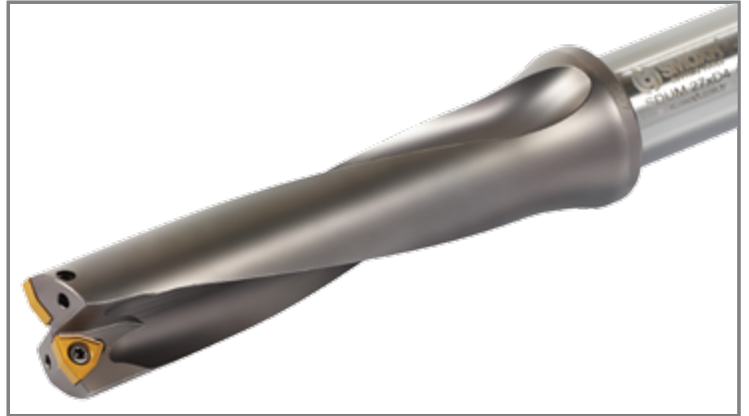
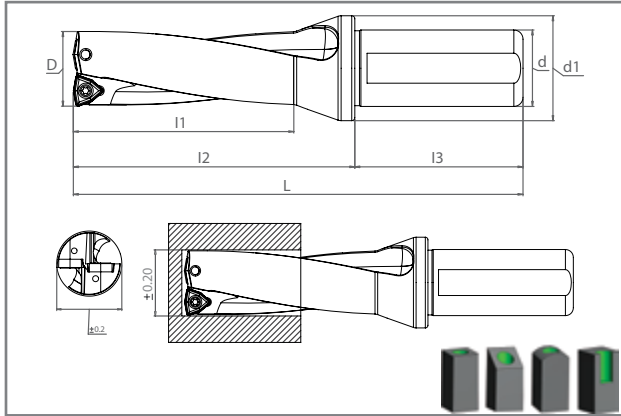
### Indexable Drills



KOD CODE	ÖLÇÜLER DIMENSION (mm)							KESİCİ UÇ INSERT	YEDEK PARÇALAR SPARE PARTS	
	D	d	d1	L	l1	l2	l3		Sıkma Vidası Clamp Screw	Anahtar Torx Key
<b>SDUM WCM. D5 U-DRILL</b>										
SDUM 16XD5 WCM.030208	16	25	34	155	80	100	56	WCM. 030208 ISO UCA UYGUNDUR FOR ISO INSERT	SSV M2.5x6 9505	T08
SDUM 17XD5 WCM.030208	17	25	34	160	85	105	56			
SDUM 18XD5 WCM.030208	18	25	34	165	90	111	56	WCM. 040208 ISO UCA UYGUNDUR FOR ISO INSERT	SSV M2.5x6 9505	T08
SDUM 19XD5 WCM.030208	19	25	34	170	95	116	56			
SDUM 20XD5 WCM.040208	20	25	34	175	100	120	56	WCM. 040208 ISO UCA UYGUNDUR FOR ISO INSERT	SSV M2.5x6 9505	T08
SDUM 21XD5 WCM.040208	21	25	34	180	105	124	56			
SDUM 22XD5 WCM.040208	22	25	34	185	110	129	56	WCM. 050308 ISO UCA UYGUNDUR FOR ISO INSERT	SSV M3x8 9508	T08
SDUM 23XD5 WCM.040208	23	25	34	190	115	135	56			
SDUM 24XD5 WCM.050308	24	25	34	195	120	140	56	WCM. 050308 ISO UCA UYGUNDUR FOR ISO INSERT	SSV M3x8 9508	T08
SDUM 25XD5 WCM.050308	25	25	34	200	125	144	56			
SDUM 26XD5 WCM.050308	26	25	34	205	130	149	56	WCM. 06T308 ISO UCA UYGUNDUR FOR ISO INSERT	SSV M3.5x10 9511	T15
SDUM 27XD5 WCM.050308	27	25	34	210	135	155	56			
SDUM 28XD5 WCM.050308	28	25	34	215	140	160	56	WCM. 06T308 ISO UCA UYGUNDUR FOR ISO INSERT	SSV M3.5x10 9511	T15
SDUM 29XD5 WCM.050308	29	25	34	220	145	165	56			
SDUM 30XD5 WCM.06T308	30	32	44	231	150	170	60	WCM. 06T308 ISO UCA UYGUNDUR FOR ISO INSERT	SSV M3.5x10 9511	T15
SDUM 31XD5 WCM.06T308	31	32	44	136	155	173	60			
SDUM 32XD5 WCM.06T308	32	32	44	241	160	180	60	WCM. 06T308 ISO UCA UYGUNDUR FOR ISO INSERT	SSV M3.5x10 9511	T15
SDUM 33XD5 WCM.06T308	33	32	44	246	165	185	60			
SDUM 34XD5 WCM.06T308	34	32	44	251	170	190	60	WCM. 06T308 ISO UCA UYGUNDUR FOR ISO INSERT	SSV M3.5x10 9511	T15
SDUM 35XD5 WCM.06T308	35	32	44	256	175	195	60			
SDUM 36XD5 WCM.06T308	36	32	44	261	180	200	60	WCM. 06T308 ISO UCA UYGUNDUR FOR ISO INSERT	SSV M3.5x10 9511	T15
SDUM 37XD5 WCM.06T308	37	32	44	266	185	205	60			
SDUM 38XD5 WCM.06T308	38	32	44	271	190	210	60	WCM. 06T308 ISO UCA UYGUNDUR FOR ISO INSERT	SSV M3.5x10 9511	T15
SDUM 39XD5 WCM.06T308	39	32	44	276	195	215	60			
SDUM 40XD5 WCM.06T308	40	32	44	281	200	220	60	WCM. 06T308 ISO UCA UYGUNDUR FOR ISO INSERT	SSV M3.5x10 9511	T15
SDUM 40XD5 WCM.06T308	40	32	44	281	200	220	60			

## DEĞİŞKEN UÇLU MATKAPLAR

### Indexable Drills

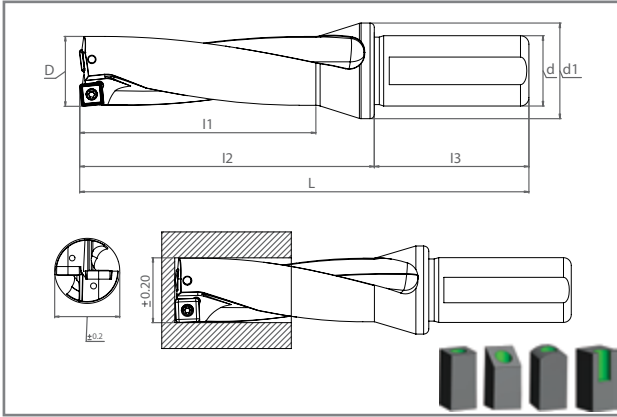



KOD CODE	ÖLÇÜLER DIMENSION (mm)							KESİCİ UÇ INSERT	YEDEK PARÇALAR SPARE PARTS	
	D	d	d1	L	I1	I2	I3		Sıkma Vidası Clamp Screw	Anahtar Torx Key
<b>SDUM SPMG D2 U-DRILL</b>										
SDUM 12.5XD2 SPMG 050204	12.5	20	25	94	25	44	50	SPMG 050204 TGTC UCA UYGUNDUR FOR TGTC INSERT	SSV M2x4 9521	T06
SDUM 13XD2 SPMG 050204	13	20	25	94	26	44	50			
SDUM 13.5XD2 SPMG 050204	13.5	20	25	96	27	46	50			
SDUM 14XD2 SPMG 050204	14	20	25	96	28	46	50			
SDUM 14.5XD2 SPMG 050204	14.5	20	25	99	29	49	50			
SDUM 15XD2 SPMG 050204	15	20	25	99	30	49	50	SPMG 060204 TGTC UCA UYGUNDUR FOR TGTC INSERT	SSV M2.2x5 9503	T07
SDUM 15.5XD2 SPMG 060204	15.5	20	25	102	31	52	50			
SDUM 16XD2 SPMG 060204	16	25	34	108	32	52	56			
SDUM 16.5XD2 SPMG 060204	16.5	25	34	110	33	54	56			
SDUM 17XD2 SPMG 060204	17	25	34	110	34	54	56			
SDUM 17.5XD2 SPMG 060204	17.5	25	34	113	35	57	56			
SDUM 18XD2 SPMG 060204	18	25	34	113	36	57	56			
SDUM 18.5XD2 SPMG 060204	18.5	25	34	115	37	59	56			
SDUM 19XD2 SPMG 060204	19	25	34	115	38	59	56			
SDUM 19.5XD2 SPMG 060204	19.5	25	34	119	39	63	56			
SDUM 20XD2 SPMG 060204	20	25	34	119	40	63	56	SPMG 07T308 TGTC UCA UYGUNDUR FOR TGTC INSERT	SSV M2.5x7 9506	T08
SDUM 20.5XD2 SPMG 060204	20.5	25	34	121	41	65	56			
SDUM 21XD2 SPMG 060204	21	25	34	121	42	65	56			
SDUM 21.5XD2 SPMG 060204	21.5	25	34	123	43	67	56			
SDUM 22XD2 SPMG 07T308	22	25	34	123	44	67	56			
SDUM 22.5XD2 SPMG 07T308	22.5	25	34	127	45	71	56			
SDUM 23XD2 SPMG 07T308	23	25	34	127	46	71	56			
SDUM 23.5XD2 SPMG 07T308	23.5	25	34	130	47	74	56			
SDUM 24XD2 SPMG 07T308	24	25	44	130	48	74	56			
SDUM 24.5XD2 SPMG 07T308	24.5	25	44	133	49	77	56			
SDUM 25XD2 SPMG 07T308	25	25	44	133	50	77	56			
SDUM 25.5XD2 SPMG 07T308	25.5	25	44	135	51	79	56			
SDUM 26XD2 SPMG 07T308	26	25	44	135	52	79	56			

## DEĞİŞKEN UÇLU MATKAPLAR

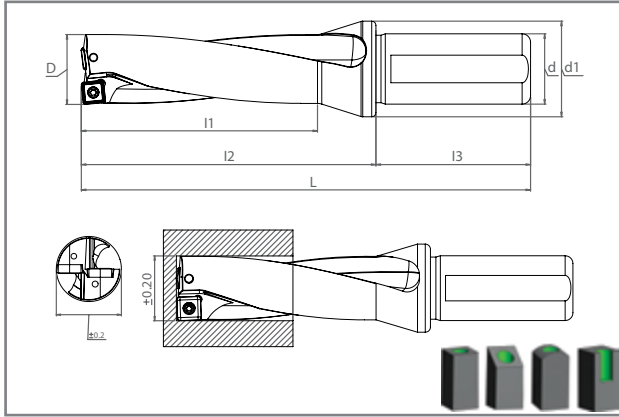
### Indexable Drills



KOD CODE	ÖLÇÜLER DIMENSION (mm)							KESİCİ UÇ INSERT	YEDEK PARÇALAR SPARE PARTS	
	D	d	d1	L	l1	l2	l3		Sıkma Vidası Clamp Screw	Anahtar Torx Key
<b>SDUM SPMG D2 U-DRILL</b>										
SDUM 26.5XD2 SPMG 07T308	26.5	25	44	137	53	81	56	<b>SPMG 07T308 TGTC UCA UYGUNDUR FOR TGTC INSERT</b>	<b>SSV M2.5x7 9506</b>	T08
SDUM 27XD2 SPMG 07T308	27	25	44	137	54	81	56			
SDUM 27.5XD2 SPMG 07T308	27.5	25	44	140	55	84	56			
SDUM 28XD2 SPMG 090408	28	25	44	140	56	84	56	<b>SPMG 090408 TGTC UCA UYGUNDUR FOR TGTC INSERT</b>	<b>SSV M3.5x10 9511</b>	T15
SDUM 28.5XD2 SPMG 090408	28.5	25	44	142	57	86	56			
SDUM 29XD2 SPMG 090408	29	25	44	142	58	86	56			
SDUM 29.5XD2 SPMG 090408	29.5	25	44	151	59	91	56			
SDUM 30XD2 SPMG 090408	30	32	44	141	60	81	60			
SDUM 31XD2 SPMG 090408	31	32	44	144	62	83	60			
SDUM 32XD2 SPMG 090408	32	32	44	146	64	86	60			
SDUM 33XD2 SPMG 090408	33	32	44	149	66	88	60			
SDUM 34XD2 SPMG 110408	34	32	44	151	68	91	60			
SDUM 35XD2 SPMG 110408	35	32	44	154	70	93	60			
SDUM 36XD2 SPMG 110408	36	32	44	157	72	96	60	<b>SPMG 110408 TGTC UCA UYGUNDUR FOR TGTC INSERT</b>	<b>SSV M4x10 9514</b>	T15
SDUM 37XD2 SPMG 110408	37	32	44	160	74	100	60			
SDUM 38XD2 SPMG 110408	38	32	44	163	76	103	60			
SDUM 39XD2 SPMG 110408	39	32	44	165	78	105	60			
SDUM 40XD2 SPMG 110408	40	32	44	168	80	108	60			
SDUM 41XD2 SPMG 110408	41	32	44	171	82	110	60			
SDUM 42XD2 SPMG 140512	42	32	44	173	84	112	60	<b>SPMG 140512 TGTC UCA UYGUNDUR FOR TGTC INSERT</b>	<b>SSV M5x13 9519</b>	T20
SDUM 43XD2 SPMG 140512	43	32	44	176	86	114	60			
SDUM 44XD2 SPMG 140512	44	32	44	178	88	117	60			
SDUM 45XD2 SPMG 140512	45	40	60	192	90	123	70			
SDUM 46XD2 SPMG 140512	46	40	60	195	92	125	70			
SDUM 47XD2 SPMG 140512	47	40	60	197	94	127	70			
SDUM 48XD2 SPMG 140512	48	40	60	200	96	130	70			
SDUM 49XD2 SPMG 140512	49	40	60	202	98	132	70			
SDUM 50XD2 SPMG 140512	50	40	60	205	100	135	70			

## DEĞİŞKEN UÇLU MATKAPLAR

### Indexable Drills

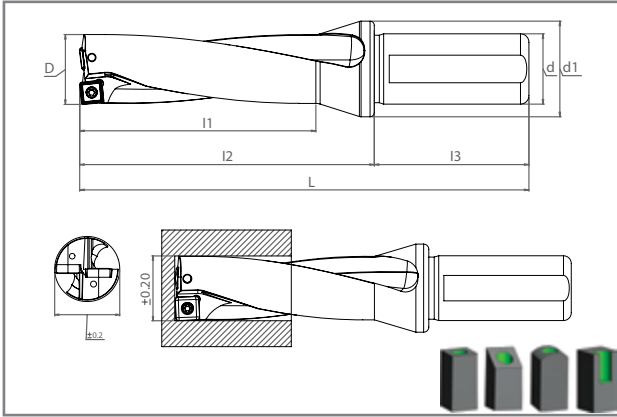



KOD CODE	ÖLÇÜLER DIMENSION (mm)							KESİCİ UÇ INSERT	YEDEK PARÇALAR SPARE PARTS	
	D	d	d1	L	I1	I2	I3		Sıkma Vidası Clamp Screw	Anahtar Torx Key
<b>SDUM SPMG D3 U-DRILL</b>										
SDUM 12.5XD3 SPMG 050204	12.5	20	25	107	37	57	50	<b>SPMG 050204 TGTC UCA UYGUNDUR FOR TGTC INSERT</b>	<b>SSV M2x4 9521</b>	T06
SDUM 13XD3 SPMG 050204	13	20	25	107	39	57	50			
SDUM 13.5XD3 SPMG 050204	13.5	20	25	110	40.5	60	50			
SDUM 14XD3 SPMG 050204	14	20	25	110	42	60	50			
SDUM 14.5XD3 SPMG 050204	14.5	20	25	113	43.5	63	50			
SDUM 15XD3 SPMG 050204	15	20	25	113	45	63	50	<b>SPMG 060204 TGTC UCA UYGUNDUR FOR TGTC INSERT</b>	<b>SSV M2.2x5 9503</b>	T07
SDUM 15.5XD3 SPMG 060204	15.5	20	25	118	46.5	68	50			
SDUM 16XD3 SPMG 060204	16	25	34	124	48	68	56			
SDUM 16.5XD3 SPMG 060204	16.5	25	34	127	49.5	71	56			
SDUM 17XD3 SPMG 060204	17	25	34	127	51	71	56			
SDUM 17.5XD3 SPMG 060204	17.5	25	34	131	52.5	75	56			
SDUM 18XD3 SPMG 060204	18	25	34	131	54	75	56			
SDUM 18.5XD3 SPMG 060204	18.5	25	34	134	55.5	78	56			
SDUM 19XD3 SPMG 060204	19	25	34	134	57	78	56			
SDUM 19.5XD3 SPMG 060204	19.5	25	34	139	58.5	83	56			
SDUM 20XD3 SPMG 060204	20	25	34	139	60	83	56	<b>SPMG 07T308 TGTC UCA UYGUNDUR FOR TGTC INSERT</b>	<b>SSV M2.5x7 9506</b>	T08
SDUM 20.5XD3 SPMG 060204	20.5	25	34	142	61.5	88	56			
SDUM 21XD3 SPMG 060204	21	25	34	142	63	88	56			
SDUM 21.5XD3 SPMG 060204	21.5	25	34	145	64.5	89	56			
SDUM 22XD3 SPMG 07T308	22	25	34	145	66	89	56			
SDUM 22.5XD3 SPMG 07T308	22.5	25	34	150	67.5	94	56			
SDUM 23XD3 SPMG 07T308	23	25	34	150	69	94	56			
SDUM 23.5XD3 SPMG 07T308	23.5	25	34	154	70.5	98	56			
SDUM 24XD3 SPMG 07T308	24	25	34	154	72	98	56			
SDUM 24.5XD3 SPMG 07T308	24.5	25	34	158	73.5	102	56			
SDUM 25XD3 SPMG 07T308	25	25	34	158	75	102	56			
SDUM 25.5XD3 SPMG 07T308	25.5	25	34	161	76.5	105	56			
SDUM 26XD3 SPMG 07T308	26	25	34	161	78	105	56			

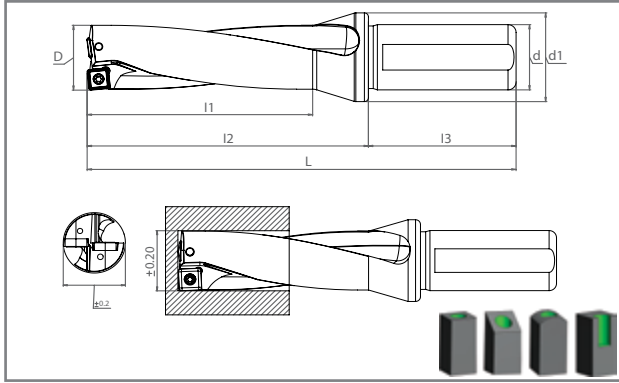

## DEĞİŞKEN UÇLU MATKAPLAR Indexable Drills



KOD CODE	ÖLÇÜLER DIMENSION (mm)							KESİCİ UÇ INSERT	YEDEK PARÇALAR SPARE PARTS	
	D	d	d1	L	l1	l2	l3		Sıkma Vidası Clamp Screw	Anahtar Torx Key
<b>SDUM SPMG D3 U-DRILL</b>										
SDUM 26.5XD3 SPMG 07T308	26.5	25	34	164	79.5	108	56	SPMG 07T308 TGTC UCA UYGUNDUR FOR TGTC INSERT	SSV M2.5x7 9506	T08
SDUM 27XD3 SPMG 07T308	27	25	34	164	81	108	56			
SDUM 27.5XD3 SPMG 07T308	27.5	25	34	168	82.5	112	56	SPMG 090408 TGTC UCA UYGUNDUR FOR TGTC INSERT	SSV M3.5x10 9511	T15
SDUM 28XD3 SPMG 090408	28	25	34	168	84	112	56			
SDUM 28.5XD3 SPMG 090408	28.5	25	34	171	85.5	115	56			
SDUM 29XD3 SPMG 090408	29	25	34	171	87	115	56			
SDUM 29.5XD3 SPMG 090408	29.5	25	34	177	88.5	111	56			
SDUM 30XD3 SPMG 090408	30	32	44	171	90	111	60			
SDUM 31XD3 SPMG 090408	31	32	44	175	93	115	60			
SDUM 32XD3 SPMG 090408	32	32	44	178	96	118	60			
SDUM 33XD3 SPMG 090408	33	32	44	182	99	122	60			
SDUM 34XD3 SPMG 110408	34	32	44	185	102	125	60			
SDUM 35XD3 SPMG 110408	35	32	44	189	105	129	60	SPMG 110408 TGTC UCA UYGUNDUR FOR TGTC INSERT	SSV M4x10 9514	T15
SDUM 36XD3 SPMG 110408	36	32	44	193	108	133	60			
SDUM 37XD3 SPMG 110408	37	32	44	197	111	136	60			
SDUM 38XD3 SPMG 110408	38	32	44	201	114	141	60			
SDUM 39XD3 SPMG 110408	39	32	44	204	117	144	60			
SDUM 40XD3 SPMG 110408	40	32	44	208	120	148	60			
SDUM 41XD3 SPMG 110408	41	32	44	212	123	152	60	SPMG 140512 TGTC UCA UYGUNDUR FOR TGTC INSERT	SSV M5x13 9519	T20
SDUM 42XD3 SPMG 140512	42	32	44	215	126	155	60			
SDUM 43XD3 SPMG 140512	43	32	44	219	129	158	60			
SDUM 44XD3 SPMG 140512	44	32	44	222	132	162	60			
SDUM 45XD3 SPMG 140512	45	40	60	237	135	167	70			
SDUM 46XD3 SPMG 140512	46	40	60	241	138	171	70			
SDUM 47XD3 SPMG 140512	47	40	60	244	141	174	70			
SDUM 48XD3 SPMG 140512	48	40	60	248	144	178	70			
SDUM 49XD3 SPMG 140512	49	40	60	251	147	181	70			
SDUM 50XD3 SPMG 140512	50	40	60	255	150	185	70			
SDUM 51XD3 SPMG 140512	51	40	60	258	153	188	70			
SDUM 52XD3 SPMG 140512	52	40	60	261	156	191	70			
SDUM 53XD3 SPMG 140512	53	40	60	264	159	194	70			
SDUM 54XD3 SPMG 140512	54	40	60	267	162	197	70			

## DEĞİŞKEN UÇLU MATKAPLAR

### Indexable Drills

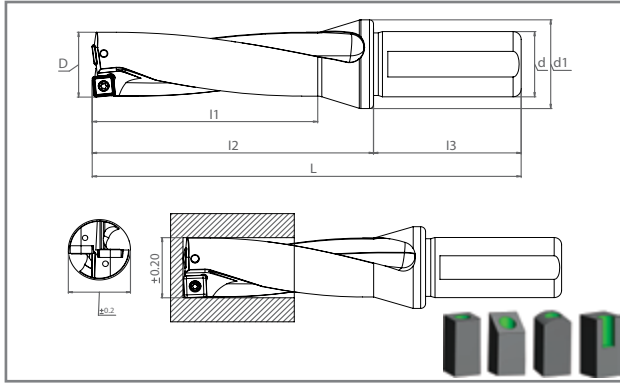



KOD CODE	ÖLÇÜLER DIMENSION (mm)							KESİCİ UÇ INSERT	YEDEK PARÇALAR SPARE PARTS	
	D	d	d1	L	l1	l2	l3		Sıkma Vidası Clamp Screw	Anahtar Torx Key
<b>SDUM SPMG D4 U-DRILL</b>										
SDUM 12.5XD4 SPMG 050204	12.5	20	25	120	52	70	50	<b>SPMG 050204 TGTC UCA UYGUNDUR FOR TGTC INSERT</b>	<b>SSV M2x4 9521</b>	T06
SDUM 13XD4 SPMG 050204	13	20	25	120	52	70	50			
SDUM 13.5XD4 SPMG 050204	13.5	20	25	120	52	70	50			
SDUM 14XD4 SPMG 050204	14	20	25	124	56	73	50			
SDUM 14.5XD4 SPMG 050204	14.5	20	25	124	56	78	50			
SDUM 15XD4 SPMG 050204	15	20	25	128	60	78	50			
SDUM 15.5XD4 SPMG 060204	15.5	20	25	128	60	85	50	<b>SPMG 060204 TGTC UCA UYGUNDUR FOR TGTC INSERT</b>	<b>SSV M2.2x5 9503</b>	T07
SDUM 16XD4 SPMG 060204	16	25	34	140	64	84	56			
SDUM 16.5XD4 SPMG 060204	16.5	25	34	144	66	84	56			
SDUM 17XD4 SPMG 060204	17	25	34	144	68	88	56			
SDUM 17.5XD4 SPMG 060204	17.5	25	34	149	70	88	56			
SDUM 18XD4 SPMG 060204	18	25	34	149	72	93	56			
SDUM 18.5XD4 SPMG 060204	18.5	25	34	153	74	93	56			
SDUM 19XD4 SPMG 060204	19	25	34	153	76	97	56			
SDUM 19.5XD4 SPMG 060204	19.5	25	34	159	78	97	56			
SDUM 20XD4 SPMG 060204	20	25	34	159	80	103	56			
SDUM 20.5XD4 SPMG 060204	20.5	25	34	163	82	103	56			
SDUM 21XD4 SPMG 060204	21	25	34	163	84	107	56			
SDUM 21.5XD4 SPMG 060204	21.5	25	34	167	86	107	56			
SDUM 22XD4 SPMG 07T308	22	25	34	167	88	111	56			
SDUM 22.5XD4 SPMG 07T308	22.5	25	34	173	90	111	56			
SDUM 23XD4 SPMG 07T308	23	25	34	173	92	117	56			
SDUM 23.5XD4 SPMG 07T308	23.5	25	34	178	94	117	56			
SDUM 24XD4 SPMG 07T308	24	25	34	178	96	122	56			
SDUM 24.5XD4 SPMG 07T308	24.5	25	34	183	98	122	56			
SDUM 25XD4 SPMG 07T308	25	25	34	183	100	127	56			
SDUM 25.5XD4 SPMG 07T308	25.5	25	34	187	102	127	56			
SDUM 26XD4 SPMG 07T308	26	25	34	187	104	131	56			
SDUM 26.5XD4 SPMG 07T308	26.5	25	34	191	106	131	56			
SDUM 27XD4 SPMG 07T308	27	25	34	191	108	135	56	<b>SPMG 090408 TGTC UCA UYGUNDUR FOR TGTC INSERT</b>	<b>SSV M3.5x10 9511</b>	T15
SDUM 27.5XD4 SPMG 07T308	27.5	25	34	196	110	135	56			
SDUM 28XD4 SPMG 090408	28	25	34	196	112	140	56			
SDUM 28.5XD4 SPMG 090408	28.5	25	34	200	114	140	56			
SDUM 29XD4 SPMG 090408	29	25	34	200	116	144	56			
SDUM 29.5XD4 SPMG 090408	29.5	25	34	202	118	144	56			
SDUM 30XD4 SPMG 090408	30	32	44	201	120	141	60			
SDUM 31XD4 SPMG 090408	31	32	44	206	124	145	60			
SDUM 32XD4 SPMG 090408	32	32	44	210	128	149	60			
SDUM 33XD4 SPMG 090408	33	32	44	215	132	154	60			
SDUM 33.5XD4 SPMG 090408	33.5	32	44	219	134	158	60			

## DEĞİŞKEN UÇLU MATKAPLAR

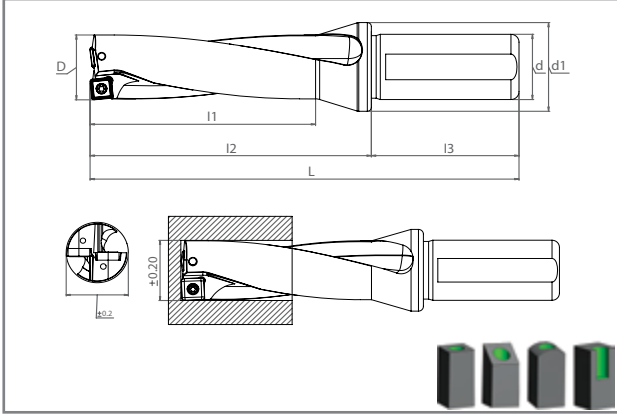
### Indexable Drills



KOD CODE	ÖLÇÜLER DIMENSION (mm)							KESİCİ UÇ INSERT	YEDEK PARÇALAR SPARE PARTS	
	D	d	d1	L	l1	l2	l3		Sıkma Vidası Clamp Screw	Anahtar Torx Key
<b>SDUM SPMG D4 U-DRILL</b>										
SDUM 34XD4 SPMG 110408	34	32	44	219	136	158	60	SPMG 110408 TGTC UCA UYGUNDUR FOR TGTC INSERT	SSV M4x10 9514	T15
SDUM 35XD4 SPMG 110408	35	32	44	227	140	166	60			
SDUM 36XD4 SPMG 110408	36	32	44	229	144	169	60			
SDUM 37XD4 SPMG 110408	37	32	44	234	148	172	60			
SDUM 38XD4 SPMG 110408	38	32	44	239	152	178	60			
SDUM 38.5XD4 SPMG 110408	38.5	32	44	243	154	181	60			
SDUM 39XD4 SPMG 110408	39	32	44	243	156	181	60			
SDUM 40XD4 SPMG 110408	40	32	44	248	160	188	60			
SDUM 41XD4 SPMG 110408	41	32	44	253	164	191	60			
SDUM 42XD4 SPMG 140512	42	32	44	257	168	195	60			
SDUM 43XD4 SPMG 140512	43	32	44	262	172	197	60			
SDUM 44XD4 SPMG 140512	44	32	44	266	176	200	60			

## DEĞİŞKEN UÇLU MATKAPLAR

### Indexable Drills

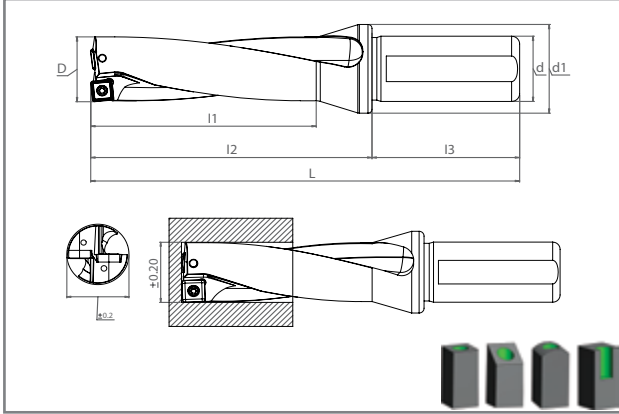



KOD CODE	ÖLÇÜLER DIMENSION (mm)							KESİCİ UÇ INSERT	YEDEK PARÇALAR SPARE PARTS	
	D	d	d1	L	l1	l2	l3		Sıkma Vidası Clamp Screw	Anahtar Torx Key
<b>SDUM SPMG D5 U-DRILL</b>										
SDUM 13XD5 SPMG 050204	13	20	25	130	65	80	50	<b>SPMG 050204</b> TGTC UCA UYGUNDUR FOR TGTC INSERT	SSV M2x4 <b>9521</b>	T06
SDUM 14XD5 SPMG 050204	14	20	25	135	70	85	50			
SDUM 15XD5 SPMG 050204	15	20	25	140	75	90	50			
SDUM 16XD5 SPMG 060204	16	25	34	155	80	100	56			
SDUM 17XD5 SPMG 060204	17	25	34	160	85	105	56			
SDUM 18XD5 SPMG 060204	18	25	34	165	90	111	56	<b>SPMG 060204</b> TGTC UCA UYGUNDUR FOR TGTC INSERT	SSV M2.2x5 <b>9503</b>	T07
SDUM 19XD5 SPMG 060204	19	25	34	170	95	116	56			
SDUM 20XD5 SPMG 060204	20	25	34	175	100	120	56			
SDUM 21XD5 SPMG 060204	21	25	34	180	105	124	56			
SDUM 22XD5 SPMG 07T308	22	25	34	185	110	129	56			
SDUM 23XD5 SPMG 07T308	23	25	34	190	115	135	56			
SDUM 24XD5 SPMG 07T308	24	25	34	195	120	140	56	<b>SPMG 07T308</b> TGTC UCA UYGUNDUR FOR TGTC INSERT	SSV M2.5x7 <b>9506</b>	T08
SDUM 25XD5 SPMG 07T308	25	25	34	200	125	144	56			
SDUM 26XD5 SPMG 07T308	26	25	34	205	130	149	56			
SDUM 27XD5 SPMG 07T308	27	25	34	210	135	155	56			
SDUM 28XD5 SPMG 090408	28	25	34	215	140	160	56			
SDUM 29XD5 SPMG 090408	29	25	34	220	145	165	56	<b>SPMG 090408</b> TGTC UCA UYGUNDUR FOR TGTC INSERT	SSV M3.5x10 <b>9511</b>	T15

## DEĞİŞKEN UÇLU MATKAPLAR

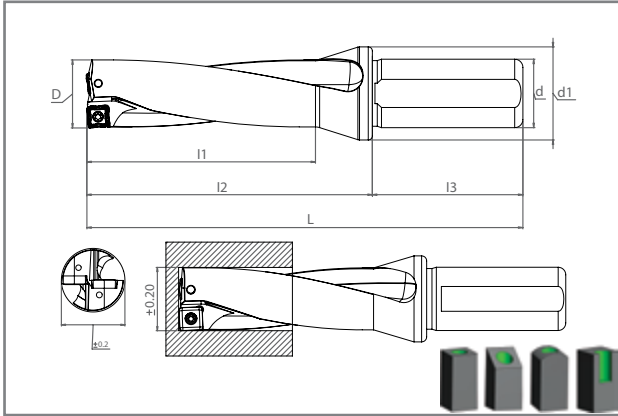
### Indexable Drills



KOD CODE	ÖLÇÜLER DIMENSION (mm)							KESİCİ UÇ INSERT	YEDEK PARÇALAR SPARE PARTS	
	D	d	d1	L	l1	l2	l3		Sıkma Vidası Clamp Screw	Anahtar Torx Key
<b>SDUM SOMT D3 U-DRILL</b>										
SDUM 14XD3 SOMT 050204	14	20	25	110	42	60	50	<b>SOMT 050204 TGTC UCA UYGUNDUR FOR TGTC INSERT</b>	<b>SSV M2.2x5 9503</b>	T06
SDUM 14.5XD3 SOMT 050204	14.5	20	25	113	43.5	63	50			
SDUM 15XD3 SOMT 050204	15	20	25	113	45	63	50			
SDUM 15.5XD3 SOMT 050204	15.5	20	25	118	46.5	68	50			
SDUM 16XD3 SOMT 050204	16	25	34	124	48	68	56			
SDUM 16.5XD3 SOMT 060204	16.5	25	34	127	49.5	71	56			
SDUM 17XD3 SOMT 060204	17	25	34	127	51	71	56	<b>SOMT 060204 TGTC UCA UYGUNDUR FOR TGTC INSERT</b>	<b>SSV M2.2x5 9503</b>	T06
SDUM 17.5XD3 SOMT 060204	17.5	25	34	131	52.5	75	56			
SDUM 18XD3 SOMT 060204	18	25	34	131	54	75	56			
SDUM 18.5XD3 SOMT 060204	18.5	25	34	134	55.5	78	56			
SDUM 19XD3 SOMT 060204	19	25	34	134	57	78	56			
SDUM 19.5XD3 SOMT 070306	19.5	25	34	139	58.5	83	56			
SDUM 20XD3 SOMT 070306	20	25	34	139	60	83	56	<b>SOMT 070306 TGTC UCA UYGUNDUR FOR TGTC INSERT</b>	<b>SSV M2.5x6 9505</b>	T08
SDUM 20.5XD3 SOMT 070306	20.5	25	34	142	61.5	88	56			
SDUM 21XD3 SOMT 070306	21	25	34	142	63	88	56			
SDUM 21.5XD3 SOMT 070306	21.5	25	34	145	64.5	89	56			
SDUM 22XD3 SOMT 070306	22	25	34	145	66	89	56			
SDUM 22.5XD3 SOMT 08T306	22.5	25	34	150	67.5	94	56			
SDUM 23XD3 SOMT 08T306	23	25	34	150	69	94	56	<b>SOMT 08T306 TGTC UCA UYGUNDUR FOR TGTC INSERT</b>	<b>SSV M2.5x6 9505</b>	T10
SDUM 23.5XD3 SOMT 08T306	23.5	25	34	154	70.5	98	56			
SDUM 24XD3 SOMT 08T306	24	25	34	154	72	98	56			
SDUM 24.5XD3 SOMT 08T306	24.5	25	34	158	73.5	102	56			
SDUM 25XD3 SOMT 08T306	25	25	34	158	75	102	56			
SDUM 25.5XD3 SOMT 08T306	25.5	25	34	161	76.5	105	56			
SDUM 26XD3 SOMT 08T306	26	25	34	161	78	105	56	<b>SOMT 09T308 TGTC UCA UYGUNDUR FOR TGTC INSERT</b>	<b>SSV M3.5x8-SC 9513</b>	T10
SDUM 26.5XD3 SOMT 09T308	26.5	25	34	164	79.5	108	56			
SDUM 27XD3 SOMT 09T308	27	25	34	164	81	108	56			
SDUM 27.5XD3 SOMT 09T308	27.5	25	34	168	82.5	112	56			
SDUM 28XD3 SOMT 09T308	28	25	34	168	84	112	56			
SDUM 28.5XD3 SOMT 09T308	28.5	25	34	171	85.5	115	56			
SDUM 29XD3 SOMT 09T308	29	25	34	171	87	115	56			
SDUM 29.5XD3 SOMT 09T308	29.5	25	34	177	88.5	111	56			
SDUM 30XD3 SOMT 09T308	30	32	44	171	90	111	60			

## DEĞİŞKEN UÇLU MATKAPLAR

### Indexable Drills

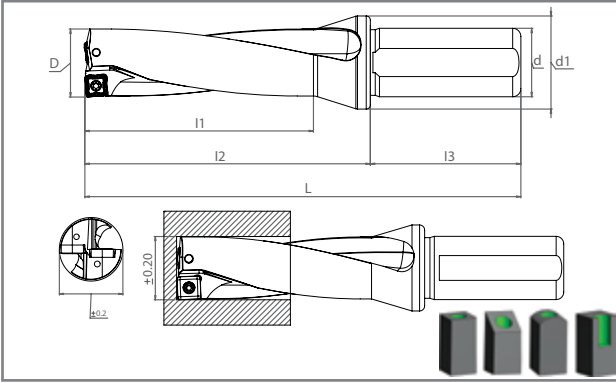

KOD CODE	ÖLÇÜLER DIMENSION (mm)							KESİCİ UÇ INSERT	YEDEK PARÇALAR SPARE PARTS	
	D	d	d1	L	l1	l2	l3		Sıkma Vidası Clamp Screw	Anahtar Torx Key
<b>SDUM SOMT D4 U-DRILL</b>										
SDUM 14XD4 SOMT 050204	14	20	25	124	56	73	50	SOMT 050204 TGTC UCA UYGUNDUR FOR TGTC INSERT	SSV M2.2x5 9503	T06
SDUM 15XD4 SOMT 050204	15	20	25	128	60	78	50			
SDUM 16XD4 SOMT 050204	16	25	34	140	64	84	56			
SDUM 17XD4 SOMT 060204	17	25	34	144	68	88	56	SOMT 060204 TGTC UCA UYGUNDUR FOR TGTC INSERT	SSV M2.2x5 9503	T06
SDUM 18XD4 SOMT 060204	18	25	34	149	72	93	56			
SDUM 19XD4 SOMT 060204	19	25	34	153	76	97	56	SOMT 070306 TGTC UCA UYGUNDUR FOR TGTC INSERT	SSV M2.5x6 9505	T08
SDUM 20XD4 SOMT 070306	20	25	34	159	80	103	56			
SDUM 21XD4 SOMT 070306	21	25	34	163	84	107	56			
SDUM 22XD4 SOMT 070306	22	25	34	167	88	111	56	SOMT 08T306 TGTC UCA UYGUNDUR FOR TGTC INSERT	SSV M2.5x6 9505	T08
SDUM 23XD4 SOMT 08T306	23	25	34	173	92	117	56			
SDUM 24XD4 SOMT 08T306	24	25	34	178	96	122	56			
SDUM 25XD4 SOMT 08T306	25	25	34	183	100	127	56	SOMT 09T308 TGTC UCA UYGUNDUR FOR TGTC INSERT	SSV M3.5x8-SC 9513	T10
SDUM 26XD4 SOMT 08T306	26	25	34	187	104	131	56			
SDUM 27XD4 SOMT 09T308	27	25	34	191	108	135	56			
SDUM 28XD4 SOMT 09T308	28	25	34	196	112	140	56	SOMT 09T308 TGTC UCA UYGUNDUR FOR TGTC INSERT	SSV M3.5x8-SC 9513	T10
SDUM 29XD4 SOMT 09T308	29	25	34	200	116	144	56			
SDUM 30XD4 SOMT 09T308	30	32	44	201	120	141	60			

KOD CODE	ÖLÇÜLER DIMENSION (mm)							KESİCİ UÇ INSERT	YEDEK PARÇALAR SPARE PARTS	
	D	d	d1	L	l1	l2	l3		Sıkma Vidası Clamp Screw	Anahtar Torx Key
<b>SDUM SOMT D5 U-DRILL</b>										
SDUM 14XD5 SOMT 050204	14	20	25	135	70	85	50	SOMT 050204 TGTC UCA UYGUNDUR FOR TGTC INSERT	SSV M2.2x5 9503	T06
SDUM 15XD5 SOMT 050204	15	20	25	140	75	90	50			
SDUM 16XD5 SOMT 050204	16	25	34	155	80	100	56			
SDUM 17XD5 SOMT 060204	17	25	34	160	85	105	56	SOMT 060204 TGTC UCA UYGUNDUR FOR TGTC INSERT	SSV M2.2x5 9503	T06
SDUM 18XD5 SOMT 060204	18	25	34	165	90	111	56			
SDUM 19XD5 SOMT 060204	19	25	34	170	95	116	56	SOMT 070306 TGTC UCA UYGUNDUR FOR TGTC INSERT	SSV M2.5x6 9505	T08
SDUM 20XD5 SOMT 070306	20	25	34	175	100	120	56			
SDUM 21XD5 SOMT 070306	21	25	34	180	105	124	56			
SDUM 22XD5 SOMT 070306	22	25	34	185	110	129	56	SOMT 08T306 TGTC UCA UYGUNDUR FOR TGTC INSERT	SSV M2.5x6 9505	T08
SDUM 23XD5 SOMT 08T306	23	25	34	190	115	135	56			
SDUM 24XD5 SOMT 08T306	24	25	34	195	120	140	56			
SDUM 25XD5 SOMT 08T306	25	25	34	200	125	144	56	SOMT 09T308 TGTC UCA UYGUNDUR FOR TGTC INSERT	SSV M3.5x8-SC 9513	T10
SDUM 26XD5 SOMT 08T306	26	25	34	205	130	149	56			
SDUM 27XD5 SOMT 09T308	27	25	34	210	135	155	56			
SDUM 28XD5 SOMT 09T308	28	25	34	215	140	160	56	SOMT 09T308 TGTC UCA UYGUNDUR FOR TGTC INSERT	SSV M3.5x8-SC 9513	T10
SDUM 29XD5 SOMT 09T308	29	25	34	220	145	165	56			
SDUM 30XD5 SOMT 09T308	30	32	44	231	150	170	60			

## DEĞİŞKEN UÇLU MATKAPLAR

### Indexable Drills

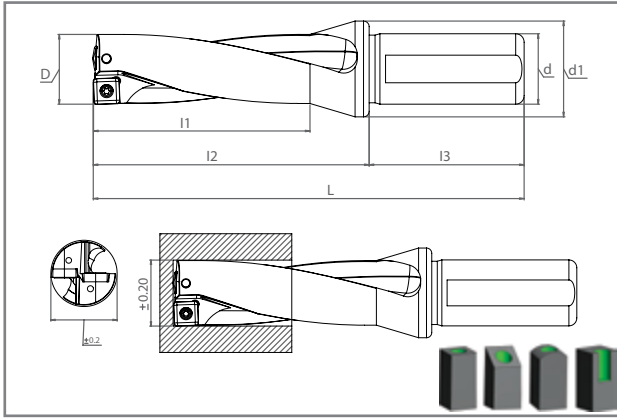

KOD CODE	ÖLÇÜLER DIMENSION (mm)							KESİCİ UÇ INSERT	YEDEK PARÇALAR SPARE PARTS	
	D	d	d1	L	l1	l2	l3		Sıkma Vidası Clamp Screw	Anahtar Torx Key
<b>SDUM SPMT(PD) / XOMT(PD) D3 K-DRILL</b>										
SDUM 12.5XD3 SP-XO04	12.5	20	25	107	37	57	50	SPMT(PD) 040204 XOMT(PD) 040204 KRLY UCA UYGUNDUR FOR KRLY INSERT		
SDUM 13XD3 SP-XO04	13	20	25	107	39	57	50			
SDUM 13.5XD3 SP-XO04	13.5	20	25	110	40.5	60	50	SPMT(PD) 050204 XOMT(PD) 050204 KRLY UCA UYGUNDUR FOR KRLY INSERT	SSV M2x4 9521	T06
SDUM 14XD3 SP-XO05	14	20	25	110	42	60	50			
SDUM 14.5XD3 SP-XO05	14.5	20	25	113	43.5	63	50			
SDUM 15XD3 SP-XO05	15	20	25	113	45	63	50			
SDUM 15.5XD3 SP-XO05	15.5	20	25	118	46.5	68	50			
SDUM 16XD3 SP-XO05	16	25	34	124	48	68	56			
SDUM 16.5XD3 SP-XO06	16.5	25	34	127	49.5	71	56	SPMT(PD) 060205 XOMT(PD) 060204 KRLY UCA UYGUNDUR FOR KRLY INSERT	SSV M2.2x5 9503	T07
SDUM 17XD3 SP-XO06	17	25	34	127	51	71	56			
SDUM 17.5XD3 SP-XO06	17.5	25	34	131	52.5	75	56			
SDUM 18XD3 SP-XO06	18	25	34	131	54	75	56			
SDUM 18.5XD3 SP-XO06	18.5	25	34	134	55.5	78	56			
SDUM 19XD3 SP-XO06	19	25	34	134	57	78	56			
SDUM 19.5XD3 SP-XO06	19.5	25	34	139	58.5	83	56	SPMT(PD) 07T208 XOMT(PD) 07T205 KRLY UCA UYGUNDUR FOR KRLY INSERT	SSV M2.5x6 9505	T08
SDUM 20XD3 SP-XO07	20	25	34	139	60	83	56			
SDUM 20.5XD3 SP-XO07	20.5	25	34	142	61.5	88	56			
SDUM 21XD3 SP-XO07	21	25	34	142	63	88	56			
SDUM 21.5XD3 SP-XO07	21.5	25	34	145	64.5	89	56			
SDUM 22XD3 SP-XO07	22	25	34	145	66	89	56			
SDUM 22.5XD3 SP-XO07	22.5	25	34	150	67.5	94	56	SPMT(PD) 090308 XOMT(PD) 090305 KRLY UCA UYGUNDUR FOR KRLY INSERT	SSV M3x8 9508	T08
SDUM 23XD3 SP-XO07	23	25	34	150	69	94	56			
SDUM 23.5XD3 SP-XO07	23.5	25	34	154	70.5	98	56			
SDUM 24XD3 SP-XO09	24	25	34	154	72	98	56			
SDUM 24.5XD3 SP-XO09	24.5	25	34	158	73.5	102	56			
SDUM 25XD3 SP-XO09	25	25	34	158	75	102	56			
SDUM 25.5XD3 SP-XO09	25.5	25	34	161	76.5	105	56			
SDUM 26XD3 SP-XO09	26	25	34	161	78	105	56			
SDUM 26.5XD3 SP-XO09	26.5	25	34	164	79.5	108	56			
SDUM 27XD3 SP-XO09	27	25	34	164	81	108	56			
SDUM 27.5XD3 SP-XO09	27.5	25	34	168	82.5	112	56			
SDUM 28XD3 SP-XO09	28	25	34	168	84	112	56			
SDUM 28.5XD3 SP-XO09	28.5	25	34	171	85.5	115	56			
SDUM 29XD3 SP-XO09	29	25	34	171	87	115	56			
SDUM 29.5XD3 SP-XO09	29.5	25	34	177	88.5	111	56	SPMT(PD) 11T308 XOMT(PD) 11T306 KRLY UCA UYGUNDUR FOR KRLY INSERT	SSV M3.5x10 9511	T15
SDUM 30XD3 SP-XO11	30	32	44	171	90	111	60			

## DEĞİŞKEN UÇLU MATKAPLAR

### Indexable Drills

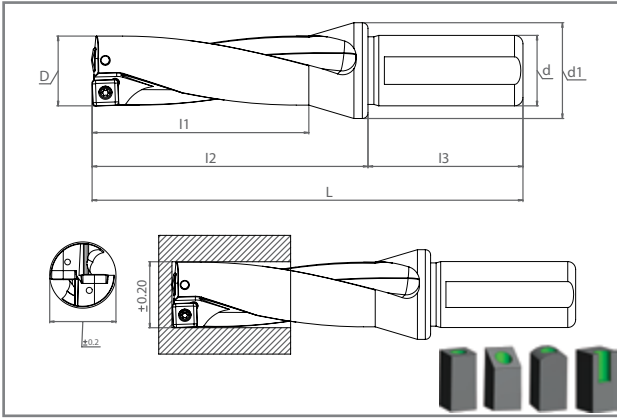





KOD CODE	ÖLÇÜLER DIMENSION (mm)							KESİCİ UÇ INSERT	YEDEK PARÇALAR SPARE PARTS	
	D	d	d1	L	I1	I2	I3		Sıkma Vidası Clamp Screw	Anahtar Torx Key
<b>SDUM SPMT(PD) / XOMT(PD) D4 K-DRILL</b>										
SDUM 12.5XD4 SP-XO04	12.5	20	25	120	52	70	50	SPMT(PD) 040204 XOMT(PD) 040204 KRLY UCA UYGUNDUR FOR KRLY INSERT	SSV M2x4 9521	T06
SDUM 13XD4 SP-XO04	13	20	25	120	52	70	50			
SDUM 13.5XD4 SP-XO04	13.5	20	25	120	52	70	50	SPMT(PD) 050204 XOMT(PD) 050204 KRLY UCA UYGUNDUR FOR KRLY INSERT	SSV M2.2x5 9503	T07
SDUM 14XD4 SP-XO05	14	20	25	124	56	73	50			
SDUM 14.5XD4 SP-XO05	14.5	20	25	124	56	78	50	SPMT(PD) 060205 XOMT(PD) 060204 KRLY UCA UYGUNDUR FOR KRLY INSERT	SSV M2.5x6 9505	T08
SDUM 15XD4 SP-XO05	15	20	25	128	60	78	50			
SDUM 15.5XD4 SP-XO05	15.5	20	25	128	60	85	50	SPMT(PD) 07T208 XOMT(PD) 07T205 KRLY UCA UYGUNDUR FOR KRLY INSERT	SSV M3x8 9508	T08
SDUM 16XD4 SP-XO05	16	25	34	140	64	84	56			
SDUM 16.5XD4 SP-XO06	16.5	25	34	144	66	84	56	SPMT(PD) 090308 XOMT(PD) 090305 KRLY UCA UYGUNDUR FOR KRLY INSERT	SSV M3.5x10 9511	T15
SDUM 17XD4 SP-XO06	17	25	34	144	68	88	56			
SDUM 17.5XD4 SP-XO06	17.5	25	34	149	70	88	56	SPMT(PD) 11T308 XOMT(PD) 11T306 KRLY UCA UYGUNDUR FOR KRLY INSERT	SSV M3.5x10 9511	T15
SDUM 18XD4 SP-XO06	18	25	34	149	72	93	56			
SDUM 18.5XD4 SP-XO06	18.5	25	34	153	74	93	56	SPMT(PD) 11T308 XOMT(PD) 11T306 KRLY UCA UYGUNDUR FOR KRLY INSERT	SSV M3.5x10 9511	T15
SDUM 19XD4 SP-XO06	19	25	34	153	76	97	56			
SDUM 19.5XD4 SP-XO06	19.5	25	34	159	78	97	56	SPMT(PD) 11T308 XOMT(PD) 11T306 KRLY UCA UYGUNDUR FOR KRLY INSERT	SSV M3.5x10 9511	T15
SDUM 20XD4 SP-XO07	20	25	34	159	80	103	56			
SDUM 20.5XD4 SP-XO07	20.5	25	34	163	82	103	56	SPMT(PD) 11T308 XOMT(PD) 11T306 KRLY UCA UYGUNDUR FOR KRLY INSERT	SSV M3.5x10 9511	T15
SDUM 21XD4 SP-XO07	21	25	34	163	84	107	56			
SDUM 21.5XD4 SP-XO07	21.5	25	34	167	86	107	56	SPMT(PD) 11T308 XOMT(PD) 11T306 KRLY UCA UYGUNDUR FOR KRLY INSERT	SSV M3.5x10 9511	T15
SDUM 22XD4 SP-XO07	22	25	34	167	88	111	56			
SDUM 22.5XD4 SP-XO07	22.5	25	34	173	90	111	56	SPMT(PD) 11T308 XOMT(PD) 11T306 KRLY UCA UYGUNDUR FOR KRLY INSERT	SSV M3.5x10 9511	T15
SDUM 23XD4 SP-XO07	23	25	34	173	92	117	56			
SDUM 23.5XD4 SP-XO07	23.5	25	34	178	94	117	56	SPMT(PD) 11T308 XOMT(PD) 11T306 KRLY UCA UYGUNDUR FOR KRLY INSERT	SSV M3.5x10 9511	T15
SDUM 24XD4 SP-XO09	24	25	34	178	96	122	56			
SDUM 24.5XD4 SP-XO09	24.5	25	34	183	98	122	56	SPMT(PD) 11T308 XOMT(PD) 11T306 KRLY UCA UYGUNDUR FOR KRLY INSERT	SSV M3.5x10 9511	T15
SDUM 25XD4 SP-XO09	25	25	34	183	100	127	56			
SDUM 25.5XD4 SP-XO09	25.5	25	34	187	102	127	56	SPMT(PD) 11T308 XOMT(PD) 11T306 KRLY UCA UYGUNDUR FOR KRLY INSERT	SSV M3.5x10 9511	T15
SDUM 26XD4 SP-XO09	26	25	34	187	104	131	56			
SDUM 26.5XD4 SP-XO09	26.5	25	34	191	106	131	56	SPMT(PD) 11T308 XOMT(PD) 11T306 KRLY UCA UYGUNDUR FOR KRLY INSERT	SSV M3.5x10 9511	T15
SDUM 27XD4 SP-XO09	27	25	34	191	108	135	56			
SDUM 27.5XD4 SP-XO09	27.5	25	34	196	110	135	56	SPMT(PD) 11T308 XOMT(PD) 11T306 KRLY UCA UYGUNDUR FOR KRLY INSERT	SSV M3.5x10 9511	T15
SDUM 28XD4 SP-XO09	28	25	34	196	112	140	56			
SDUM 28.5XD4 SP-XO09	28.5	25	34	200	114	140	56	SPMT(PD) 11T308 XOMT(PD) 11T306 KRLY UCA UYGUNDUR FOR KRLY INSERT	SSV M3.5x10 9511	T15
SDUM 29XD4 SP-XO09	29	25	34	200	116	144	56			
SDUM 29.5XD4 SP-XO09	29.5	25	34	202	118	144	56	SPMT(PD) 11T308 XOMT(PD) 11T306 KRLY UCA UYGUNDUR FOR KRLY INSERT	SSV M3.5x10 9511	T15
SDUM 30XD4 SP-XO11	30	32	44	201	120	141	60			

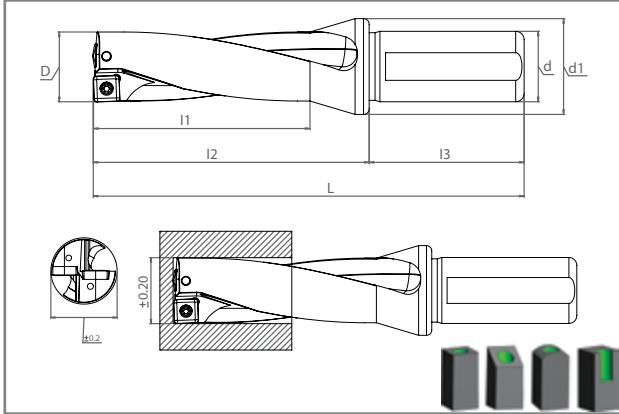

## DEĞİŞKEN UÇLU MATKAPLAR

### Indexable Drills



KOD CODE	ÖLÇÜLER DIMENSION (mm)							KESİCİ UÇ INSERT	YEDEK PARÇALAR SPARE PARTS	
	D	d	d1	L	l1	l2	l3		Sıkma Vidası Clamp Screw	Anahtar Torx Key
<b>SDUM SPMT(PD) / XOMT(PD) D5 K-DRILL</b>										
SDUM 13XD5 SP-XO04	13	20	25	130	65	80	50	SPMT(PD) 040204 XOMT(PD) 040204 KRLY UCA UYGUNDUR FOR KRLY INSERT	SSV M2x4 9521	T06
SDUM 14XD5 SP-XO05	14	20	25	135	70	85	50	SPMT(PD) 050204 XOMT(PD) 050204 KRLY UCA UYGUNDUR FOR KRLY INSERT		
SDUM 15XD5 SP-XO05	15	20	25	140	75	90	50	SPMT(PD) 060205 XOMT(PD) 060204 KRLY UCA UYGUNDUR FOR KRLY INSERT		
SDUM 16XD5 SP-XO05	16	25	34	155	80	100	56	SPMT(PD) 060205 XOMT(PD) 060204 KRLY UCA UYGUNDUR FOR KRLY INSERT	SSV M2.2x5 9503	T07
SDUM 17XD5 SP-XO06	17	25	34	160	85	105	56	SPMT(PD) 07T208 XOMT(PD) 07T205 KRLY UCA UYGUNDUR FOR KRLY INSERT		
SDUM 18XD5 SP-XO06	18	25	34	165	90	111	56	SPMT(PD) 090308 XOMT(PD) 090308 KRLY UCA UYGUNDUR FOR KRLY INSERT	SSV M2.5x6 9505	T08
SDUM 19XD5 SP-XO06	19	25	34	170	95	116	56			
SDUM 20XD5 SP-XO07	20	25	34	175	100	120	56			
SDUM 21XD5 SP-XO07	21	25	34	180	105	124	56			
SDUM 22XD5 SP-XO07	22	25	34	185	110	129	56			
SDUM 23XD5 SP-XO07	23	25	34	190	115	135	56			
SDUM 24XD5 SP-XO09	24	25	34	195	120	140	56			
SDUM 25XD5 SP-XO09	25	25	34	200	125	144	56			
SDUM 26XD5 SP-XO09	26	25	34	205	130	149	56			
SDUM 27XD5 SP-XO09	27	25	34	210	135	155	56			
SDUM 28XD5 SP-XO09	28	25	34	215	140	160	56			
SDUM 29XD5 SP-XO09	29	25	34	220	145	165	56			
SDUM 30XD5 SP-XO11	30	32	44	231	150	170	60	SPMT(PD) 11T308 XOMT(PD) 11T305 KRLY UCA UYGUNDUR FOR KRLY INSERT	SSV M3.5x10 9511	T15

## DEĞİŞKEN UÇLU MATKAPLAR

### Indexable Drills

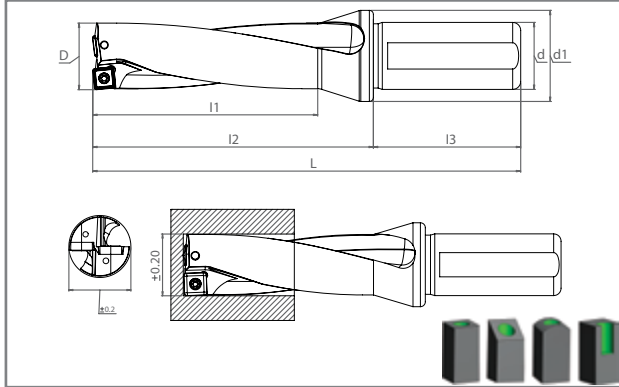



KOD CODE	ÖLÇÜLER DIMENSION (mm)							KESİCİ UÇ INSERT	YEDEK PARÇALAR SPARE PARTS	
	D	d	d1	L	l1	l2	l3		Sıkma Vidası Clamp Screw	Anahtar Torx Key
<b>SDUM SPGT D3 U-DRILL</b>										
SDUM 13XD3 SPGT 050204	13	20	25	107	39	57	50	<b>SPGT 050204 -PM/EM ZCC-CT UCA UYGUNDUR FOR ZCC-CT INSERT</b>	<b>SSV M2x4 9521</b>	T06
SDUM 13.5XD3 SPGT 050204	13.5	20	25	110	40.5	60	50			
SDUM 14XD3 SPGT 050204	14	20	25	110	42	60	50			
SDUM 14.5XD3 SPGT 050204	14.5	20	25	113	43.5	63	50			
SDUM 15XD3 SPGT 050204	15	20	25	113	45	63	50			
SDUM 15.5XD3 SPGT 060204	15.5	20	25	118	46.5	68	50	<b>SPGT 060204 -PM/EM ZCC-CT UCA UYGUNDUR FOR ZCC-CT INSERT</b>	<b>SSV M2.2x5 9503</b>	T07
SDUM 16XD3 SPGT 060204	16	25	34	124	48	68	56			
SDUM 16.5XD3 SPGT 060204	16.5	25	34	127	49.5	71	56			
SDUM 17XD3 SPGT 060204	17	25	34	127	51	71	56			
SDUM 17.5XD3 SPGT 060204	17.5	25	34	131	52.5	75	56			
SDUM 18XD3 SPGT 060204	18	25	34	131	54	75	56			
SDUM 18.5XD3 SPGT 060204	18.5	25	34	134	55.5	78	56			
SDUM 19XD3 SPGT 060204	19	25	34	134	57	78	56			
SDUM 19.5XD3 SPGT 060204	19.5	25	34	139	58.5	83	56			
SDUM 20XD3 SPGT 060204	20	25	34	139	60	83	56			
SDUM 20.5XD3 SPGT 060204	20.5	25	34	142	61.5	88	56	<b>SPGT 07T308 -PM/EM ZCC-CT UCA UYGUNDUR FOR ZCC-CT INSERT</b>	<b>SSV M2.5x7 9506</b>	T08
SDUM 21XD3 SPGT 060204	21	25	34	142	63	88	56			
SDUM 21.5XD3 SPGT 060204	21.5	25	34	145	64.5	89	56			
SDUM 22XD3 SPGT 07T308	22	25	34	145	66	89	56			
SDUM 22.5XD3 SPGT 07T308	22.5	25	34	150	67.5	94	56			
SDUM 23XD3 SPGT 07T308	23	25	34	150	69	94	56			
SDUM 23.5XD3 SPGT 07T308	23.5	25	34	154	70.5	98	56			
SDUM 24XD3 SPGT 07T308	24	25	34	154	72	98	56			
SDUM 24.5XD3 SPGT 07T308	24.5	25	34	158	73.5	102	56			
SDUM 25XD3 SPGT 07T308	25	25	34	158	75	102	56			
SDUM 26XD3 SPGT 07T308	26	25	34	161	78	105	56	<b>SPGT 090408-PM/EM ZCC-CT UCA UYGUNDUR FOR ZCC-CT INSERT</b>	<b>SSV M3.5x10 9511</b>	T15
SDUM 27XD3 SPGT 07T308	27	25	34	164	81	108	56			
SDUM 28XD3 SPGT 090408	28	25	34	168	84	112	56			
SDUM 29XD3 SPGT 090408	29	25	34	171	87	115	56			
SDUM 30XD3 SPGT 090408	30	32	44	171	90	111	60			
SDUM 31XD3 SPGT 090408	31	32	44	175	93	115	60			
SDUM 32XD3 SPGT 090408	32	32	44	178	96	118	60			
SDUM 33XD3 SPGT 090408	33	32	44	182	99	122	60			
SDUM 34XD3 SPGT 110408	34	32	44	185	102	125	60			
SDUM 35XD3 SPGT 110408	35	32	44	189	105	129	60			
SDUM 36XD3 SPGT 110408	36	32	44	193	108	133	60			
SDUM 37XD3 SPGT 110408	37	32	44	197	111	136	60			
SDUM 38XD3 SPGT 110408	38	32	44	201	114	141	60			
SDUM 39XD3 SPGT 110408	39	32	44	204	117	144	60			
SDUM 40XD3 SPGT 110408	40	32	44	208	120	148	60			

## DEĞİŞKEN UÇLU MATKAPLAR

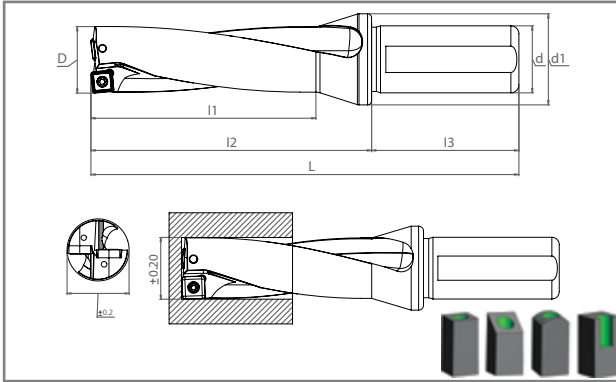
### Indexable Drills



KOD CODE	ÖLÇÜLER DIMENSION (mm)							KESİCİ UÇ INSERT	YEDEK PARÇALAR SPARE PARTS	
	D	d	d1	L	l1	l2	l3		Sıkma Vidası Clamp Screw	Anahtar Torx Key
<b>SDUM SPGT D4 U-DRILL</b>										
SDUM 13XD4 SPGT 050204	13	20	25	120	52	70	50	SPGT 050204-PM/EM ZCC-CT UCA UYGUNDUR FOR ZCC-CT INSERT	SSV M2x4 9521	T06
SDUM 14XD4 SPGT 050204	14	20	25	124	56	73	50			
SDUM 15XD4 SPGT 050204	15	20	25	128	60	78	50			
SDUM 16XD4 SPGT 060204	16	25	34	140	64	84	56	SPGT 060204-PM/EM ZCC-CT UCA UYGUNDUR FOR ZCC-CT INSERT	SSV M2.2x5 9503	T07
SDUM 17XD4 SPGT 060204	17	25	34	144	68	88	56			
SDUM 18XD4 SPGT 060204	18	25	34	149	72	93	56			
SDUM 19XD4 SPGT 060204	19	25	34	153	76	97	56			
SDUM 20XD4 SPGT 060204	20	25	34	159	80	103	56			
SDUM 21XD4 SPGT 060204	21	25	34	163	84	107	56			
SDUM 22XD4 SPGT 07T308	22	25	34	167	88	111	56	SPGT 07T308-PM/EM ZCC-CT UCA UYGUNDUR FOR ZCC-CT INSERT	SSV M2.5x7 9506	T08
SDUM 23XD4 SPGT 07T308	23	25	34	173	92	117	56			
SDUM 24XD4 SPGT 07T308	24	25	34	178	96	122	56			
SDUM 25XD4 SPGT 07T308	25	25	34	183	100	127	56			
SDUM 26XD4 SPGT 07T308	26	25	34	187	104	131	56			
SDUM 27XD4 SPGT 07T308	27	25	34	191	108	135	56			
SDUM 28XD4 SPGT 090408	28	25	34	196	112	140	56	SPGT 090408-PM/EM ZCC-CT UCA UYGUNDUR FOR ZCC-CT INSERT	SSV M3.5x10 9511	T15
SDUM 29XD4 SPGT 090408	29	25	34	200	116	144	56			
SDUM 30XD4 SPGT 090408	30	32	44	201	120	141	60			

## DEĞİŞKEN UÇLU MATKAPLAR

### Indexable Drills

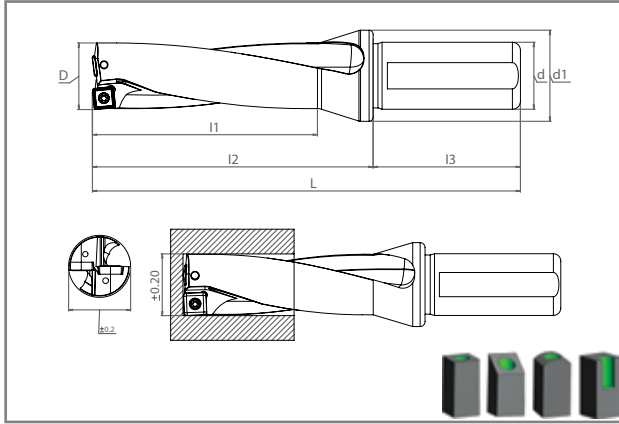



KOD CODE	ÖLÇÜLER DIMENSION (mm)							KESİCİ UÇ INSERT	YEDEK PARÇALAR SPARE PARTS	
	D	d	d1	L	l1	l2	l3		Sıkma Vidası Clamp Screw	Anahtar Torx Key
<b>SDUM SPGT D5 U-DRILL</b>										
SDUM 14XD5 SPGT 050204	14	20	25	135	70	85	50	SPGT 050204-PM/EM ZCC-CT UCA UYGUNDUR FOR ZCC-CT INSERT	SSV M2x4 9521	T06
SDUM 15XD5 SPGT 050204	15	20	25	140	75	90	50			
SDUM 16XD5 SPGT 060204	16	25	34	155	80	100	56	SPGT 060204-PM/EM ZCC-CT UCA UYGUNDUR FOR ZCC-CT INSERT	SSV M2.2x5 9503	T07
SDUM 17XD5 SPGT 060204	17	25	34	160	85	105	56			
SDUM 18XD5 SPGT 060204	18	25	34	165	90	111	56			
SDUM 19XD5 SPGT 060204	19	25	34	170	95	116	56			
SDUM 20XD5 SPGT 060204	20	25	34	175	100	120	56			
SDUM 21XD5 SPGT 060204	21	25	34	180	105	124	56			
SDUM 22XD5 SPGT 07T308	22	25	34	185	110	129	56	SPGT 07T308-PM/EM ZCC-CT UCA UYGUNDUR FOR ZCC-CT INSERT	SSV M2.5x7 9506	T08
SDUM 23XD5 SPGT 07T308	23	25	34	190	115	135	56			
SDUM 24XD5 SPGT 07T308	24	25	34	195	120	140	56			
SDUM 25XD5 SPGT 07T308	25	25	34	200	125	144	56			
SDUM 26XD5 SPGT 07T308	26	25	34	205	130	149	56			
SDUM 27XD5 SPGT 07T308	27	25	34	210	135	155	56	SPGT 090408-PM/EM ZCC-CT UCA UYGUNDUR FOR ZCC-CT INSERT	SSV M3.5x10 9511	T15
SDUM 28XD5 SPGT 090408	28	25	34	215	140	160	56			
SDUM 29XD5 SPGT 090408	29	25	34	220	145	165	56			
SDUM 30XD5 SPGT 090408	30	32	44	231	150	170	60			

## DEĞİŞKEN UÇLU MATKAPLAR

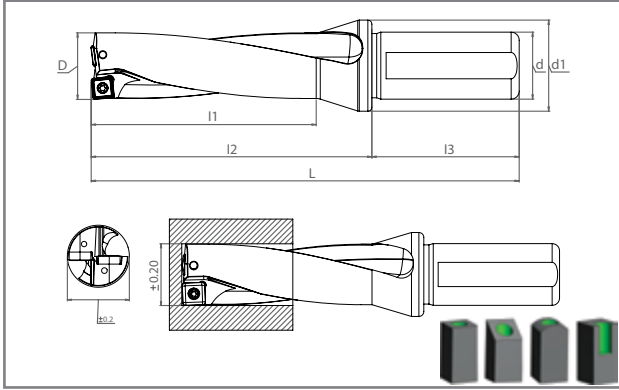
### Indexable Drills





KOD CODE	ÖLÇÜLER DIMENSION (mm)							KESİCİ UÇ INSERT	YEDEK PARÇALAR SPARE PARTS	
	D	d	d1	L	l1	l2	l3		Sıkma Vidası Clamp Screw	Anahtar Torx Key
<b>SDUM SOMX D3 U-DRILL</b>										
SDUM 14XD3 SO..050204	14	20	25	110	42	60	50	SOMX 050204 ISCR UCA UYGUNDUR FOR ISCR INSERT	SSV M2x4 9521	T06
SDUM 15XD3 SO..050204	15	20	25	113	45	63	50			
SDUM 16XD3 SO..050204	16	25	34	124	48	68	56			
SDUM 17XD3 SO..050204	17	25	34	127	51	71	56			
SDUM 18XD3 SO..060304	18	25	34	131	54	75	56	SOMX 060304 ISCR UCA UYGUNDUR FOR ISCR INSERT	SSV M2.2x5 9503	T07
SDUM 19XD3 SO..060304	19	25	34	134	57	78	56			
SDUM 20XD3 SO..060304	20	25	34	139	60	83	56	SOMT 09T306 ISCR UCA UYGUNDUR FOR ISCR INSERT	SSV M2.5x6 9505	T08
SDUM 21XD3 SO..070305	21	25	34	142	63	88	56			
SDUM 22XD3 SO..070305	22	25	34	145	66	89	56			
SDUM 23XD3 SO..070305	23	25	34	150	69	94	56			
SDUM 24XD3 SO..070305	24	25	34	154	72	98	56			
SDUM 25XD3 SO..09T306	25	25	34	158	75	102	56			
SDUM 26XD3 SO..09T306	26	25	34	161	78	105	56			
SDUM 27XD3 SO..09T306	27	25	34	164	81	108	56			
SDUM 28XD3 SO..09T306	28	25	34	168	84	112	56			
SDUM 29XD3 SO..09T306	29	25	34	171	87	115	56			
SDUM 30XD3 SO..09T306	30	32	44	171	90	111	60			
SDUM 31XD3 SO..09T306	31	32	44	175	93	115	60			
SDUM 32XD3 SO..09T306	32	32	44	178	96	118	60			
SDUM 33XD3 SO..09T306	33	32	44	182	99	122	60			
SDUM 34XD3 SO..09T306	34	32	44	185	102	125	60			
SDUM 35XD3 SO..120408	35	32	44	189	105	129	60			
SDUM 36XD3 SO..120408	36	32	44	193	108	133	60			
SDUM 37XD3 SO..120408	37	32	44	197	111	136	60			
SDUM 38XD3 SO..120408	38	32	44	201	114	141	60			
SDUM 39XD3 SO..120408	39	32	44	204	117	144	60			
SDUM 40XD3 SO..120408	40	32	44	208	120	148	60			

## DEĞİŞKEN UÇLU MATKAPLAR

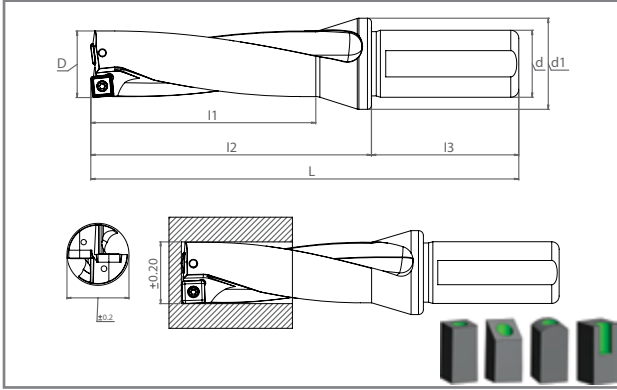

### Indexable Drills





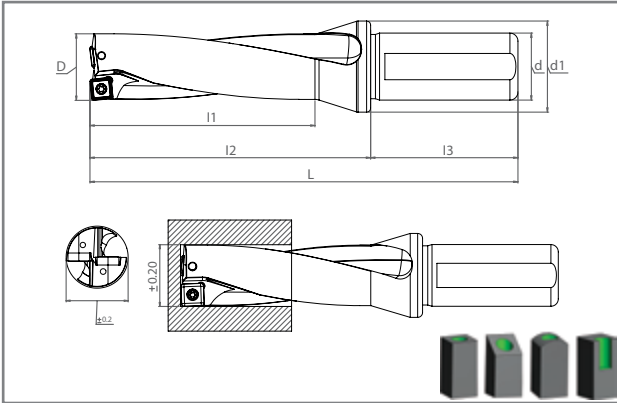

KOD CODE	ÖLÇÜLER DIMENSION (mm)							KESİCİ UÇ INSERT	YEDEK PARÇALAR SPARE PARTS	
	D	d	d1	L	l1	l2	l3		Sıkma Vidası Clamp Screw	Anahtar Torx Key
<b>SDUM SOMX D4 U-DRILL</b>										
SDUM 14XD4 SO..050204	14	20	25	124	56	73	50	SOMX 050204 ISCR UCA UYGUNDUR FOR ISCR INSERT	SSV M2x4 9521	T06
SDUM 15XD4 SO..050204	15	20	25	128	60	78	50			
SDUM 16XD4 SO..050204	16	25	34	140	64	84	56			
SDUM 17XD4 SO..050204	17	25	34	144	68	88	56			
SDUM 18XD4 SO..060304	18	25	34	149	72	93	56	SOMX 060304 ISCR UCA UYGUNDUR FOR ISCR INSERT	SSV M2.2x5 9503	T07
SDUM 19XD4 SO..060304	19	25	34	153	76	97	56			
SDUM 20XD4 SO..060304	20	25	34	159	80	103	56	SOMT 09T306 ISCR UCA UYGUNDUR FOR ISCR INSERT	SSV M2.5x6 9505	T08
SDUM 21XD4 SO..070305	21	25	34	163	84	107	56			
SDUM 22XD4 SO..070305	22	25	34	167	88	111	56			
SDUM 23XD4 SO..070305	23	25	34	173	92	117	56			
SDUM 24XD4 SO..070305	24	25	34	178	96	122	56			
SDUM 25XD4 SO..09T306	25	25	34	183	100	127	56			
SDUM 26XD4 SO..09T306	26	25	34	187	104	131	56			
SDUM 27XD4 SO..09T306	27	25	34	191	108	135	56			
SDUM 28XD4 SO..09T306	28	25	34	196	112	140	56			
SDUM 29XD4 SO..09T306	29	25	34	200	116	144	56			
SDUM 30XD4 SO..09T306	30	32	44	201	120	141	60			
SDUM 31XD4 SO..09T306	31	32	44	206	124	145	60			
SDUM 32XD4 SO..09T306	32	32	44	210	128	149	60			
SDUM 33XD4 SO..09T306	33	32	44	215	132	154	60			
SDUM 34XD4 SO..09T306	34	32	44	219	136	158	60			
SDUM 35XD4 SO..120408	35	32	44	227	140	166	60	SOMT 120408 ISCR UCA UYGUNDUR FOR ISCR INSERT	SSV M4x10 9514	T15
SDUM 36XD4 SO..120408	36	32	44	229	144	169	60			
SDUM 37XD4 SO..120408	37	32	44	234	148	172	60			
SDUM 38XD4 SO..120408	38	32	44	239	152	178	60			
SDUM 39XD4 SO..120408	39	32	44	243	156	181	60			
SDUM 40XD4 SO..120408	40	32	44	248	160	188	60			

## MULTI CUT Multi Cut

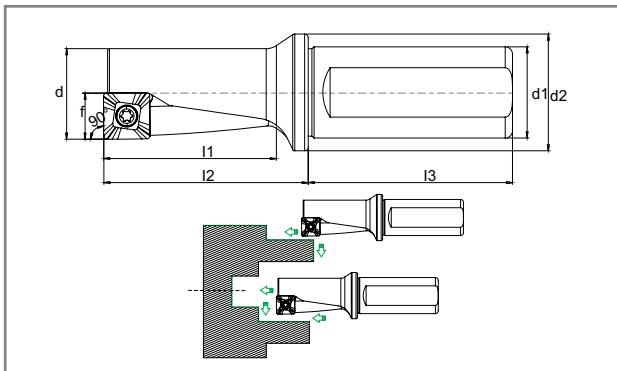

KOD CODE	ÖLÇÜLER DIMENSION (mm)							KESİCİ UÇ INSERT	YEDEK PARÇALAR SPARE PARTS	
	D	d	d1	L	l1	l2	l3		Sıkma Vidası Clamp Screw	Anahtar Torx Key
<b>SDUM SOMX D5 U-DRILL</b>										
SDUM 14XD5 SO..050204	14	20	25	135	70	85	50	SOMX 050204 ISCR UCA UYGUNDUR FOR ISCR INSERT	SSV M2x4 9521	T06
SDUM 15XD5 SO..050204	15	20	25	140	75	90	50			
SDUM 16XD5 SO..050204	16	25	34	155	80	100	56			
SDUM 17XD5 SO..050204	17	25	34	160	85	105	56			
SDUM 18XD5 SO..060304	18	25	34	165	90	111	56	SOMX 060304 ISCR UCA UYGUNDUR FOR ISCR INSERT	SSV M2.2x5 9503	T07
SDUM 19XD5 SO..060304	19	25	34	170	95	116	56			
SDUM 20XD5 SO..060304	20	25	34	175	100	120	56	SOMX 070305 ISCR UCA UYGUNDUR FOR ISCR INSERT	SSV M2.5x6 9505	T08
SDUM 21XD5 SO..070305	21	25	34	180	105	124	56			
SDUM 22XD5 SO..070305	22	25	34	185	110	129	56			
SDUM 23XD5 SO..070305	23	25	34	190	115	135	56			
SDUM 24XD5 SO..070305	24	25	34	195	120	140	56	SOMT 09T306 ISCR UCA UYGUNDUR FOR ISCR INSERT	SSV M3x7 9527	T08
SDUM 25XD5 SO..09T306	25	25	34	200	125	144	56			
SDUM 26XD5 SO..09T306	26	25	34	205	130	149	56			
SDUM 27XD5 SO..09T306	27	25	34	210	135	155	56			
SDUM 28XD5 SO..09T306	28	25	34	215	140	160	56			
SDUM 29XD5 SO..09T306	29	25	34	220	145	165	56			
SDUM 30XD5 SO..09T306	30	32	44	231	150	170	60			



KOD CODE	ÖLÇÜLER DIMENSION (mm)							KESİCİ UÇ INSERT	YEDEK PARÇALAR SPARE PARTS	
	d	d1	d2	l1	l2	l3	F		Sıkma Vidası Clamp Screw	Anahtar Allen Key
<b>SMC XCMT MULTI CUT TGTC</b>										
SMC 10x2.5 XC05	10	12	16	25	30	42	5	XC.. 0502.. TGTC	SSV M2x5-9502	T06
SMC 12x2.5 XC06	12	16	20	30	35	45	6	XC.. 0602.. TGTC	SSV M2.2x5-9503	T07
SMC 16x2.5 XC08	16	20	25	40	45	50	8	XC.. 0803.. TGTC	SSV M3x8-9508	T08
SMC 20x2.5 XC10	20	25	32	50	55	56	10	XC.. 10T3.. TGTC	SC-SSV M3.5x8-9513	T10
SMC 25x2.5 XC13	25	32	40	62.5	69	60	12.5	XC.. 1304.. TGTC	SSV M4.5x11-9518	T20
SMC 32x2.5 XC17	32	40	50	80	88	70	16	XC.. 1705.. TGTC		

**Teknoloji profesyonellikle birleŖti**  
Technology combined with professionalism

















[www.smoxx.com.tr](http://www.smoxx.com.tr)

## **YEDEK PARÇALAR**

Spare Parts







KOD / CODE		AÇIKLAMASI / DETAILS
	TSK1-9101	DNMG 15. CNMG 12.WNMG 08. SNMG 12 PABUÇ / CLAMP
	TSK2-9102	DNMG 11 PABUÇ / CLAMP
	TSK3-9103	CNMG 16. SNMG 15 PABUÇ / CLAMP
	TSK4-9104	CNMG 19 PABUÇ / CLAMP
	TSK5-9105	VNMG 16 PABUÇ / CLAMP
	TSK6-9106	CNMG 12 (S20R TCLNR/L) PABUÇ / CLAMP
	MSK1-9107	TNMG 16.22 PABUÇ / CLAMP
	MSK2-9108	TNMG 16 (S20R MTUNR/L) PABUÇ / CLAMP
	MSK3-9109	WNMG 08 PABUÇ / CLAMP
	MSK4-9110	WNMG 06 PABUÇ / CLAMP
	CSK1/R - 9111	KNUX 16 (S25 CKUNR-16) PABUÇ / CLAMP
	CSK1/L - 9119	KNUX 16 (S25 CKUNL-16) PABUÇ / CLAMP
	CSK/2R - 9112	KNUX 16-R PABUÇ / CLAMP
	CSK6/R - 9117	KNUX 16-R (2020 CKJNR K16) PABUÇ / CLAMP
	CSK3/L - 9113	KNUX 16-L PABUÇ / CLAMP
	CSK7/R - 9118	KNUX 16-L (2020 CKJNL K16) PABUÇ / CLAMP
	CSK4-9114	TN.N 16 SERAMİK ELMAS / CERAMIC INSERT
	CSK5-9115	DN.N 15.- CN.N 12.- SN.N 12 SERAMİK ELMAS / CERAMIC INSERT
	SPL1 - 9120	CNMG 12.- WNMG 08.- SNMG 12 LEVYE / LEVER
	SPL2 - 9121	CNMG 16.- SNMG 15 LEVYE / LEVER
	SPL3 - 9122	CNMG 19- SNMG19 LEVYE / LEVER
	SPL4 - 9123	DNMG 15. LEVYE / LEVER
	PSK1 - 9124	P SİSTEM SOĞUTMA ÜNİTESİ / P SYSTEM COOLING UNIT
	RKR1 M8x1 - 9321	SOĞUTMA RAKORU / FITTING



## YEDEK PARÇALAR

### Spare Parts

	KOD / CODE	AÇIKLAMASI / DETAILS
	TSBV M5x16 - 9222	S16P - WNMG-06 BASKI VİDASI / CLAP SCREW
	TSBV M5x18 - 9201	S20R - WNMG-06.TNMG 16 BASKI VİDASI / CLAP SCREW
	TSBV M5x24 - 9202	S25S - DNMG-11.WNMG-06.TNMG 16 BASKI VİDASI / CLAP SCREW
	TSBV M5x25	DNMG 11.WNMG 06.TNMG 16 BASKI VİDASI / CLAP SCREW
	TSBV M6x30-9205	DNMG 15.WNMG 08.TNMG 16-22.CNMG 12. VNMG 16 PABUÇ VİDASI / CLAMP SCREW
	TSBV M6x30x7-9206	CNMG 16 BASKI VİDASI / CLAMP SCREW
	TSBV M8x30-9207	CNMG 19 BASKI VİDASI / CLAMP SCREW
	CSBV M8x30x11-9208	SERAMİK TAKIMLAR BASKI VİDASI / CERAMIC TOOLS CLAMP SCREW
	CSBV M6x20-9206	S25S - KNUX-R/L 16 BASKI VİDASI / CLAMP SCREW
	CSBV M6x30-9223	2525 - 3232 CKJNR/L-16 BASKI VİDASI / CLAMP SCREW
	SLV1 M8x19-9224	CNMG 12. SNMG 12. WNMG 08 LEVYE VİDASI/ LEVER SCREW
	SLV2 M8x21-9225	DNMG15. CNMG 16. SNMG 15 LEVYE VİDASI/LEVER SCREW
	SLV3 M10x28-9226	CNMG 19 LEVYE VİDASI/LEVER SCREW
	BKTV M4x14-9210	16 LİK İÇ VE DIŞ KANAL TAKIM VİDASI / FOR 16 INTERNAL AND EXTERNAL GROOVING SCREW - SBT 20-24 KARTUŞ VİDASI / SBT 20-24 CARTRIDGE SCREW
	BKTV M5x17-9211	1212 BKDT/R - 20 LİK İÇ VE DIŞ KANAL TAKIM VİDASI/ FOR 20 INTERNAL AND EXTERNAL GROOVING SCREW
	BKTV M5x20x8-9212	SBT 24-29 KARTUŞ VİDASI / SBT 24-29 CARTRIDGE SCREW
	BKTV M6x20x8-9213	SBT 29-39 KARTUŞ VİDASI / SBT 29-39 CARTRIDGE SCREW
	BKTV M6x22-9214	25 LİK İÇ VE DIŞ KANAL TAKIM VİDASI/ FOR 25 INTERNAL AND EXTERNAL GROOVING SCREW
	BKTV M6x25-9215	32 LİK İÇ VE 1616-2020-2525 DIŞ KANAL TAKIM VİDASI/ FOR 32 INTERNAL AND 1616-2020-2525 EXTERNAL GROOVING SCREW - D50 DKT VİDASI / D50 DKT SCREW
	BKTV M8x30-9216	40 LİK İÇ VE 3232 DIŞ KANAL TAKIM VİDASI / FOR 40 INTERNAL AND 3232 EXTERNAL GROOVING SCREW - D63-D80 DKT VİDASI / D63-D80 DKT SCREW
	BKTV M8x30x11-9217	SBT 39-49 / 49-60 / 59-79 / 69-89 / 89-130 KARTUŞ VİDASI SBT 39-49 / 49-60 / 59-79 / 69-89 / 89-130 CARTRIDGE SCREW
	TPBV 6x10-9218	TPKN 16 BASKI VİDASI / TPKN 16 CLAMP SCREW
	TPBV 8x10-9219	TPKN 22 BASKI VİDASI / TPKN 22 CLAMP SCREW
	TKBP-9116	OFER 07,SPKN 12,TPKN 16-22 BASKI PABUCU OFER 07,SPKN 12,TPKN 16-22 CLAMP





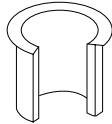











## YEDEK PARÇALAR Spare Parts

KOD / CODE		AÇIKLAMASI / DETAILS
	TC170 3x7-9801	SRT P3208 VİDASI / SRT P3208 SCREW
	TC172 4x0.5x9-9802	SRT P3210 VİDASI / SRT P3210 SCREW
	TC174 5x0.5x9-9803	SRT P3212 VİDASI / SRT P3212 SCREW
	TC176 5x0.5x12-9804	SRT P3216 VİDASI / SRT P3216 SCREW
	TC178 5x0.5x12-9805	SRT P3220 VİDASI / SRT P3220 SCREW
	TC181 6x0.75x20-9806	SRT P3225 VİDASI / SRT P3225 SCREW
	TC184 8x0.75x24-9807	SRT P3232 VİDASI / SRT P3232 SCREW

KOD / CODE		AÇIKLAMASI
	SNSV M3x6-9301	SBT 20-24 KARTUŞ AYAR VİDASI / CARTRIDGE ADJUSTMENT SCREW
	SNSV M4x8-9302	SBT 24-29 KARTUŞ AYAR VİDASI / CARTRIDGE ADJUSTMENT SCREW
	SNSV M4x10-9303	SBT 29-39 KARTUŞ AYAR VİDASI / CARTRIDGE ADJUSTMENT SCREW
	SNSV M4x12-9304	SBT 39-49 KARTUŞ AYAR VİDASI / CARTRIDGE ADJUSTMENT SCREW
	SNSV M4x16-9305	SBT 49-60 KARTUŞ AYAR VİDASI / CARTRIDGE ADJUSTMENT SCREW
	SNSV M5x15-9307	SBT 59-79 / 69-89 KARTUŞ AYAR VİDASI / CARTRIDGE ADJUSTMENT SCREW
	SNSV M5x15-9318	SBT 89-130 / 89-130 KARTUŞ AYAR VİDASI / CARTRIDGE ADJUSTMENT SCREW
	SNSV M6x10-9308	4x10MM(2525) PUNTA TAKIM VİDASI 4x10MM(2525) CENTERING TOOLS SCREW
	BMP1-3.70x5x16-9309	TNMG 16 PİM / PIN
	BMP2-5x6x16-9310	TNMG 22 PİM/PIN
	BMP3-5x6x16-9311	WNMG 08 PİM/PIN
	BMP3-3.70x5x13-9312	WNMG 06 PİM/PIN
	BMP5-3.70x5x13-9313	S20R TNMG 16 PİM / PIN
	SLAY1-9701	DNMG 15. CNMG 12. SNMG 12. WNMG 08 ALTLIK YAYI / SHIM SPRING
	SLAY2-9702	CNMG 16. SNMG 15 ALTLIK YAYI / SHIM SPRING
	SLAY3-9703	CNMG 19. SNMG 19 ALTLIK YAYI / SHIM SPRING

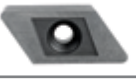
## YEDEK PARÇALAR

### Spare Parts

	KOD / CODE	AÇIKLAMASI / DETAILS
	BAX DN11-9601	DNMG 11 ALTLIK / SHIM
	BAX DN15-9602	DNMG 15 ALTLIK / SHIM
	BAX CN12-9603	CNMG 12 ALTLIK / SHIM
	BAX CN16-9304	CNMG 16 ALTLIK / SHIM
	BAX CN19-9605	CNMG 19 ALTLIK / SHIM
	BAX WN06-9606	WNMG 08 ALTLIK / SHIM
	BAX WN08-9607	WNMG 08 ALTLIK / SHIM
	BAX SN12-9608	SNMG 12 ALTLIK / SHIM
	BAX SN15-9609	SNMG 15 ALTLIK / SHIM
	BAX SN19-9629	SNMG 19 ALTLIK / SHIM
	BAX TN16-9610	TNMG 16 ALTLIK / SHIM
	BAX TN22-9611	TNMG 22 ALTLIK / SHIM
	BAX VN16-9612	VNMG 16 ALTLIK / SHIM
	BAX DC11-9613	DCMT 11 ALTLIK / SHIM
	BAX SC09-9614	SCMT 09 ALTLIK / SHIM
	BAX SC12-9615	SCMT 12 ALTLIK / SHIM
	BAX CC09-9616	CCMT 09 ALTLIK / SHIM
	BAX CC12-9617	CCMT 12 ALTLIK / SHIM
	BAX VB16-9618	VBMT 16 ALTLIK / SHIM
	BAX TC16-9619	TCMT 16 ALTLIK / SHIM
	BAX VC16-9620	VCMT 16 ALTLIK / SHIM
	BAX KN16/R-9621	KNUX/R 16 ALTLIK / SHIM
	BAX KN16/L-9622	KNUX/L 16 ALTLIK / SHIM
	BAX ER/L16-R/L-9623	ER/L 16-R/L ALTLIK / SHIM
	BAX ER/L22-R/L-9624	ER/L 22-R/L ALTLIK / SHIM
	BAX IR/L16-R/L-9623	IR/L 16-R/L ALTLIK / SHIM
	BAX IR/L22-R/L-9623	IR/L 22-R/L ALTLIK / SHIM
	BAX TER16-9625	TER 16 ALTLIK / SHIM
	BAX TEL16-9626	TEL 16 ALTLIK / SHIM
	BAX TER 22-9627	TER 22 ALTLIK / SHIM
	BAX TEL 22-9628	TEL 22 ALTLIK / SHIM





ÜRÜN KODU	AÇIKLAMASI / DETAILS
SSV M1.8x4-9501	APKT 0602.. / <b>APMT 0602..</b> / AXMT 0602.. / <b>EOMT 0602..</b> / LPMT 0402.. <b>XOMX 0602..</b>
SSV M2x4-9521	BDMT 0703.. / <b>3PKT 0603..</b> / LPGT 0102.. / <b>SPMG 050204</b> / SPMT(PD) 050204 <b>XOMT(PD) 050204</b> / SPGT 050204 -PM/EM / <b>SOMX 050204</b> / TCM.06T1 (S0610F)
SSV M2x5-9502	3PKT-0603.. / <b>ADMX 0702..</b> / RT 0702.. / <b>XC.. 0502..</b>
SSV M2.2x5-9503	ACOMT 0702.. / <b>TCM.0902..(1010-1212-S10K-S12K)</b> / 08 IR/IL / XOMX0602.. / <b>XDKT 0703..</b> SPMG 060204 / <b>SPMT(PD)0602..</b> / XOMT(PD)0602.. / <b>SPGT 0602..</b> / SOMT 060204.. <b>SOMX 060304..</b> / XC.. 0602..
SSV M2.5x5-9504	TOMT 0603.. / <b>BDMT 1103..</b> / EDPT 10T3.. / <b>WCM.0302..</b> / CCM. 0602..(S0608H-S08H) <b>VBM. 1103..(S16P-S20R)</b> / VCM.1103.. (S16P-S20R) / <b>TCM.1102..(S10K-S12K-S16P-S20R)</b> WCM.0302..(S0608-S0810) / <b>AP.. 1003.(D12-D14)</b> / APKT 09T3..(D16) / <b>R390.11T3..(D16)</b> ADMT 0803..(D16-D20) / <b>RT 1003..(D16 ~ D18)</b> / XOMX 10T3..(D16) / <b>AOMT 1236..(D16-D20)</b> XDKT 11T3..(D16-D17) / <b>JOMT 06T2..(D16-D17)</b>
SSV M2.5x6-9505	APKT 09T3.. / <b>AP.. 1003.(D16 ~ D42)</b> / R390.11T3..(D20 ~ D25) / <b>6NKU 0403..(D20)</b> APKT 1003..(D16-D20) / <b>APMT 1135..(D16-D20)</b> / EDPT 10T3..(D16 ~ D20) / <b>ADMT 0803(D25)</b> ADMT 10T3.. (D16 ~ D25) / <b>RT 1003(D20 ~ D32)</b> / XOMX 10T3..(D20) / <b>AOMT1236(D22-D25)</b> LNMT 0804..(D16) / <b>RDKW 0702..</b> / 14 CPT / <b>WNMX 0603..(D16 ~ D21)</b> / <b>XPLX 0603..</b> / BLMP 0603.. (D16) / <b>ZPMT 1003..(D16 ~ D20)</b> / <b>WOM.04T2..</b> / BNGX 10T3..(D16 ~ D20) ADMT 0803.. (D25) / <b>ADMX 11T3..(D20)</b> / TNGX 1004..(D20) / <b>XNEX 0403..(D17-D20)</b> / JOMT06T2.. (D20-D22) / <b>WDMT0603.. (D16-D18)</b> /XPLT0603(D16-D20)/ <b>BDMT1103(D20-D32)</b> RD..0702(D17) / <b>SPMG 07T308</b> / LNMU 0303.. (D16) / <b>ENMU 1004..(D16)</b> / DCM. 0702.. CCM.0602.. / <b>VBM. 1103..</b> / VC.T 1103.. / <b>TCM.1102..</b> / RC.T 0803.. / <b>NFTG08</b> 11 ER/EL / <b>11 IR/IL</b> / WCM. 030208 / <b>WCM. 040208</b> / SOMT 08T306 / <b>SPMT(PD) 07T208</b> XOMT(PD) 07T205 /
SSV M2.5x7-9506	APKT 1003..(D25-D125) / <b>EDPT 10T3..(D25-D63)</b> / ADMX 11T3..(D20-D63) / <b>APKT 11T3..</b> <b>(D40-D63)</b> APMT 11T3..(D40-D63) / <b>APMT 1135..(D40-D80)</b> / R390.11T3(D40-D63) <b>AOMT 1206..(D40-D100)</b> / ADMT 10T3..(D40-D63) / <b>RT 1003(D40-D63)</b> / <b>TNGX 1004..</b> <b>(D40-D63)</b> / <b>LN.. 0804..(D40-D80)</b> / 490R-08T3(D40-D63) / <b>3PKT 1004..(D40-D63)</b> / 6NKU 0403..(D25-D32) / <b>TNGX 1004..(D25-D32)</b> / XDKT 11T3..(D20-D26) / <b>LNMT 0804..(D20-D32)</b> / WNMX0603..(D25-D33) / <b>LNMU 0303..(D20-D50)</b> / ENMU 1004..(D25-D63) / <b>ZPMT1003(D25-D32)</b> / BNGX10T3(D25-D50) / <b>WDMT 0603..(D20-D22)</b> / XPLT 0603.. (D25-D32) / <b>LNMU 0303..(D20-D25)</b> / BLMP 0603..(D40-D50) / <b>CC..0602..(TF90 CC06</b> <b>D23-D60)</b> / RD..0702(TF RD07 D25-D35) / <b>CC..0602..(BSDF CC06 D60-D160)</b> / TCM..1102.. (HF45 TC11 D4-15) / <b>SPMG 07T308</b> / SPGT 07T308 -PM/EM / <b>SOMX 070305</b>
SSV M3x5-9524	3P.T 1004..(D16) / <b>XNKT 0604..(D20-D25)</b>
SSV M3x5 LG-9525	AX.T 1235..(D16) / <b>LOMU / LOGT 1004..(D16)</b> / 4NKT 0603..
SSV M3x6-9507	EDPT 1404..(D14) / <b>ADKT 1204..(D20-D25)</b> / XNEX 0403..(D25-D32) / <b>LNHU 0904..(D20)</b> / XNKT 0604..(D20-D42) / <b>3P.T 1004..(D16-D32)</b> / RD.. 0803.. / <b>SPKT 08T3..</b> / JOMT 0803.. (D17-D26) / <b>WDMT 0804..(D20-D22)</b> / EDPT 1404..(D20) / <b>LNMX 1006..(D20)</b>
SSV M3x7-9527	SOMT 09T306
SSV M3x8-9508	<b>EDPT 1404..(D25-D40)</b> / ADKT 1204..(D20-D32) / <b>LNHU 0904..</b> / LN.X 1006.. / <b>ANGX 1105..</b> / XNKT 0604..(D22-D33) / <b>RPMT / RPGT 10T3..</b> / WNMX 09T3.. / <b>ZDCW09T3</b> / JOMT 0803.. (D26) / <b>WDMT 0804..(D25-D33)</b> EDPT 1404..(D25-D80) / <b>AXMT 1235..</b> / HNGX 0604.. / <b>WOEJ 0905..</b> / <b>SPKT 08T3..(D40-D63)</b> / WCM. 050308 / <b>SPMT(PD) 090308</b> / XOMT(PD) 090305 / <b>XC.. 0803..</b> / RC.T 0803..
SSV M3x6 LG-9509	AXMT 1235..(D20-D25) / <b>LOMU / LOGT 1004..(D20-D63)</b> / TN.X 1005.. / LOGU 0303..
SSV M3.5x8-9510	16 IR/IL(S16x13M) / <b>R390.1704..</b> / LNGX 1205.. / <b>SPMG 090408</b> / QPMT 10T3.. / <b>RD.. 1003..</b> <b>(D20)</b> / XDLX 09T3..(D25-D32) / <b>R210-09..(D25-D26)</b> / SPNW 1004..(D25) / <b>JDM 09T3..</b> <b>(D25-D26)</b> / XDLT 0904.. / <b>AP.. 1604..(D25-D35)</b>
SSV M3.5x10-9511	R210.09..(D32-D35) / <b>CC..09T3..(TF90 CC09 D42-D45,BSDF CC09 D80-D160)</b> <b>SPMG 0904..(TF90 SP09 D37-D42,HF45 SP09 D21-25)</b> / RD..1003(TF RD10 D21-D125) <b>RD..10T3..</b> / <b>RD..1204..</b> / RD..12T3 (TF RD12 D26) / <b>RPMT 10T3..</b> / QPMT 10T3.. <b>RCKT 10T3..</b> / RCKT 1204.. / <b>RP.X 1204..</b> / RCKT 1204.. / <b>P SİSTEM SOĞUTMA ÜNİTESİ</b> / <b>P SYSTEM COOLING UNIT</b> / DCM. 11T3..(1212 , S16P-S25S) / <b>SCM. 09T3..S16P-S25S)</b> DCM.11T3..(BKRF) / <b>CCM.09T3..(1212 , S16P-S25S , TF90 CC09 D35-D45 , BSDF CC09</b> <b>D80-D160 , SBT D39-49,D49-60)</b> / RC.T 1003.. / <b>RC.T 1204..</b> / TCM.1604..(S16P-S25S , <b>HF.. TCM.16T3)</b> / VC.T 1604.. / <b>VBM. 1604..(S25)</b> / NFTG14 / <b>16 ER/EL(1616)</b> / 16 IR/IL APKT 1604.. / <b>AP.. 1604..(D36-D200)</b> / ADMT 1606.. / <b>R290.12</b> / SE..12T3.. / <b>R245.12T3</b> SEET 12T3.. / <b>490R-1404</b> / SOMT 12T3.. / <b>LNGX 1307..</b> / OD.. 0504.. / <b>VCGT 1606..</b> R390.17T4 / <b>RNMU 1003..</b> / SPNW1004..(D32) / <b>JDM 09T3..(D32-D33)</b> / RPMT 10T3.. <b>RPMT / RPGT10T3..</b> / XDLX 09T3.. (D35-D42) / <b>XDLT 0904..</b> / SDKX 1205.. / <b>BLMP 0904..</b> / WCM. 06T308 / <b>SPMG 090408</b> / SPMT(PD) 11T308 / <b>XOMT(PD) 11T306</b> / SPGT 090408-PM/ EM / <b>SOMT 09T306</b>





## YEDEK PARÇALAR

### Spare Parts

	SSV M3.5x14-9512	DCM. 11T3..(1616~3232,S32T-S40U) / <b>CCM.09T3.. (1616~2525,S25S-S32T)</b> / VBM. 1604.. (1616~3232,S32T-S40U) / <b>VC.T 1604.. (2020~3232, S32T-S40U)</b> / TCM.16T3.. (1616~3232, S32T-S40U) / <b>MGMN 2C(1010-1212 K.O)</b> / KGM 2C (1010-1212 K.O) / <b>DGN 3C (1010-1212 K.O)</b> / TDC 2C (1010-1212 K.O) / <b>16 ER/EL (2020~3232)</b>
	SSV M3.5X7SC-9513	APKT 1204.. / <b>LQMU 1107..</b> / TOMT 1004 / <b>TP.. 1003..</b> / XOMX 1204.. / <b>SDKX 0904..</b> / SDMT 09T3.. / <b>WDMW 06T3..</b> / SOMT 09T306 / <b>XC.. 10T3..</b>
	SSV M4x10-9514	NFTG16 / <b>APKT 1705..</b> / ADMX 1606.. / <b>ADKT 1505..</b> / RT 1606 / <b>AXMT 1705..</b> / BDMT 1704.. <b>AN.X 1607..</b> / LNG. 1205.. / <b>SYHU 0704..</b> / 3PKT 1505.. / <b>ZDEW 1204..</b> / SDMT 1204.. <b>JDM. 1204..</b> / WDMT 1204.. / <b>QPMT 1204..</b> / RNMU 1205.. / <b>RPMT / RPTG 1204..</b> / 21 CPT / XNKT 0805.. / <b>SOMT 1004..</b> / JDM. 09T3.. / <b>CC..1204..(TF90 CC12 D47x20)</b> / SPMG 1104.. (TF90 SP11 D47x20) / <b>RD..1604..(TF RD16 D34)</b> / SPMG 1104..(HF45° SP11 D31~45) / <b>WCM. 080412</b> / SPMG 110408 / <b>SPGT 110408-PM/EM</b> / SOMT 120408 /
	SSV M4x12-9515	SCM. 1204.. / <b>CCM.1204..</b> / XNKT 0805.. / <b>LOMU / LOGT 1505..</b> / R390.1806.. / <b>TNMX 1806..</b> / LNKT 1707.. / <b>LNGU 15T6..</b> / XNPU 15T6.. / <b>LNKT 1506..</b> / ANGX 1506.. / <b>AN.X 1205..</b> / LN.. 1306.. / <b>SN..1206..</b> / SEMT 13T3.. / <b>345-13..</b> / SDMT 1205.. / <b>WNHU 0806..</b> / XNEX0806.. <b>HNGX 0906..</b> / ONHU 0604.. / <b>HN.J 0604..</b> / HN.J 0704.. / <b>HN.J 0905..</b> / HNKX0604.. / <b>PNMU0905..</b> / SQMU 1206.. / <b>WXCU 0705..</b> / SOMT 1205..
	SSV M4x14-9516	MGMN 2C(1616 K.O) / <b>KGM 2C(1616 K.O)</b> / DGN 3C(1616 K.O) / <b>TDC 2C (1616 K.O)</b> / LN.X 1510.. / 22 ER/EL / <b>22 IR/IL</b>
	SSV M4x12x6-9517	SNMU 1305.. / <b>SNMT 1205..</b> / CCM.1204..(S25S~S40T) / <b>SCM. 1204.. (S25S~S40T)</b>
	SSV M4.5x11-9518	XOMX 1806.. / <b>RD..1604..</b> / WDMW 0805.. / <b>XC.. 1705..</b> /
	SSV M5x13-9519	RC.T 1605.. / <b>LNMU 06X5..</b> / CC..1204..(SBT CC12) / <b>AN.X 1706..</b> / WNGX0806.. / <b>WN..0806..</b> / ON.X 0504.. / <b>ON.X 0606..</b> / ON.X 0806.. / <b>ONHU 08T6..</b> / PNMU1205.. / <b>VCGT 2205..</b> / RNMU 1606.. / <b>LNMU 06X5..</b> / SPNW 1405.. / <b>WDMW 10X6..</b> / WNMU 0907.. / <b>SOMT 1405..</b> / SPMG 140512
	SSV M6x16-9520	SPEW 2006.. / <b>RC.T 2006..</b>

ÜRÜN KODU		AÇIKLAMASI / DETAILS
	TSAV-M4x10x6-9402	VNM.1604.. / <b>TN.N 1607..</b> / DNM.1104.. / <b>TNM.1604..</b> / ALTLIK VİDASI / SHIM SCREW
	TSAV-M4x10-9403	WNM.0804.. / <b>SNM.1204..</b> / DN.N 1507.. / <b>SN.N 1207..</b> / CN.N 1207.. / <b>DNM.1506..</b> / CNM.1204.. / <b>TNM.2204..</b> / VNM.1604.. / ALTLIK VİDASI / SHIM SCREW
	TSAV-M6x16x9-9404	CNM.1606.. / ALTLIK VİDASI / SHIM SCREW
	TSAV-M6x16x10-9405	SNM.1504.. / ALTLIK VİDASI / SHIM SCREW
	TSAV-M6x16x11-9406	SNM.1906.. / CNM..1906.. / ALTLIK VİDASI / SHIM SCREW
	CSAV-M3x10-9401	WNM.0604.. / KNUX16 R/L ALTLIK VİDASI / SHIM SCREW
	SBV M5x05 A3.5x11-9407	DCM. 11T3.. (1616~3232,S32T-S40U) / <b>CCM.09T3..(1616~3232)</b> / VBM. 1604.. (1616~3232 ,S32T-S40U) / <b>VCM. 1604.. (2020~3232,S32T-S40U)</b> / TCM.16T3.. (1616~3232,S32T-S40U) / <b>16 ER/EL (2020~3232)</b> / 16 IR/IL(S32S-S40T)
	SBV2 M5x05 A3.5x9-9408	DCM. 11T3..(S25S) / <b>CCM. 09T3..(S25S-S32T)</b> / VBM. 1604..(S25S) / <b>VCM.1604..(S25S)</b> / TCM.16T3..(S25S) / <b>16 ER/EL(1616)</b> / 16 IR/IL(S25R)
	SBV M6x075 A4x13-9409	22 ER/EL
	SBV1 M6x075 A4x13-9410	<b>CCM.1204.. (1616~2525,S25~S40)</b>
	SBV4 M6x075 A4x13-9412	SCM. 1204.. (1616~2525,S25~S40)
	SBV3 M6x075 A4x10-9411	22 IR/IL
	TSP 6.5x12-9705	PUL/STAMP
	CSS1-9704	SEKMAN / RING

YEDEK PARÇALAR  
Spare Parts

	T06	TORK ANAHTAR / TORX KEYS
	T07	
	T08	
	T10	
	T15	
	T20	
	AA1.5	ALYAN ANAHTAR / ALLEN KEYS
	AA2	
	AA3	
	AA3	
	AA4	
	AA5	
	AA6	

## TARAMA BAŞLIĞI MONTAJ ÖLÇÜLERİ Face Mill Mounting Dimensions

### A TİP / A Type

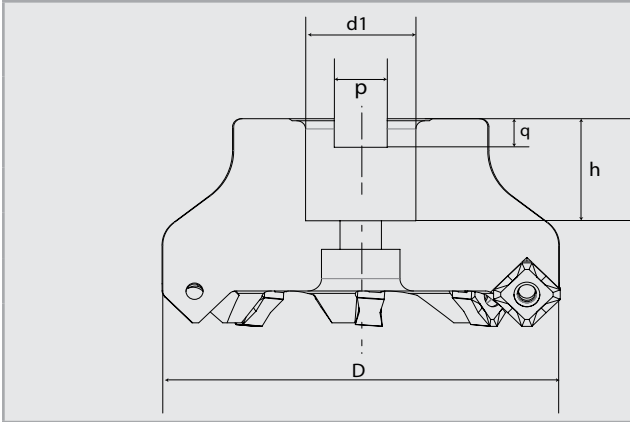

D	d1	d2	p	q	h
40	16	-	8.4	5.6	20
50	22	-	10.4	6.3	22
63	22	-	10.4	6.3	22
80	27	-	12.4	7	25
100	32	-	14.4	8	26

### B TİP / B Type

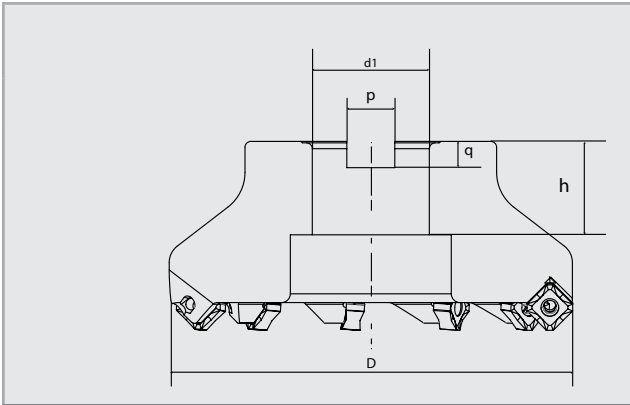

D	d1	d2	p	q	h
125	40	-	16.4	9	32

### C TİP / C Type

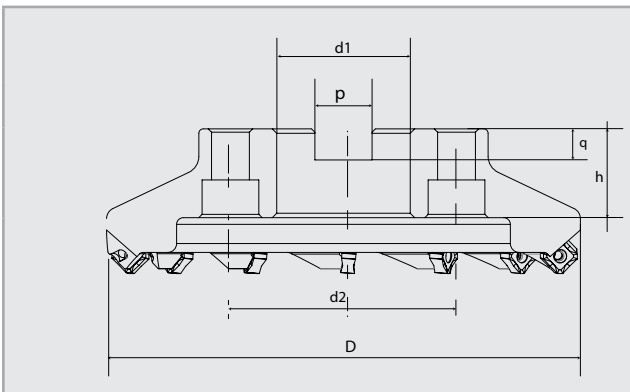

D	d1	d2	p	q	h
160	40	66.7	16.4	9	32
200	60	101.6	25.7	14	40
250	60	101.6	25.7	14	40

### D TİP / D Type

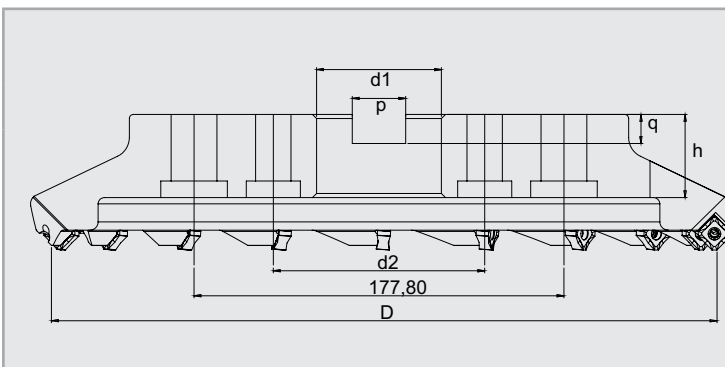

D	d1	d2	p	q	h
315	60	101.6	25.7	14	40



